

[54] LUMINAIRE

[75] Inventor: Clifford M. Laughter, Hendersonville, N.C.  
[73] Assignee: General Electric Company  
[\*\*] Term: 14 Years  
[21] Appl. No.: 803,488  
[22] Filed: Jun. 6, 1977

[51] Int. Cl. .... D26-05  
[52] U.S. Cl. .... D48/23 R  
[58] Field of Search ..... D48/23 R, 23 A, 20 E; 362/326-361, 373, 374, 376, 378, 404

[56] References Cited

U.S. PATENT DOCUMENTS

D. 213,994	4/1969	Blaisdell et al. ....	D48/23 R
2,749,433	6/1956	Appleton .....	D48/20 EX
2,866,084	12/1958	Lester .....	362/341
3,335,270	8/1967	Rongey et al. ....	362/373

OTHER PUBLICATIONS

Electrical Consultant, Feb. 1974, inside front cover, Appleton ® Mercury Vapor Fixtures.  
Electrical Consultant, Jun., 1975, p. 30-High Pressure Sodium Vapor Lighting Fixture.

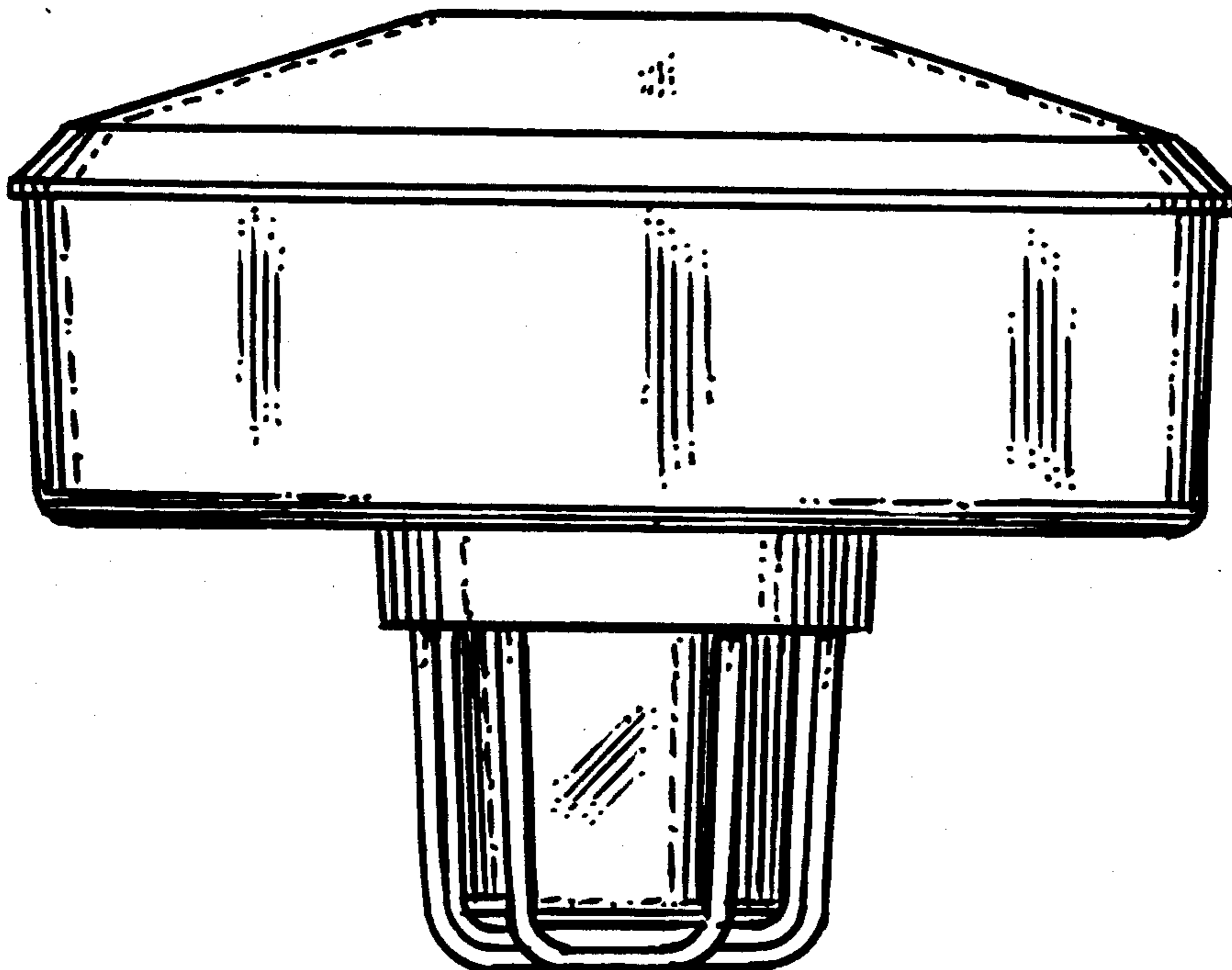
Primary Examiner—Susan J. Lucas  
Attorney, Agent, or Firm—Sidney Greenberg

[57] CLAIM

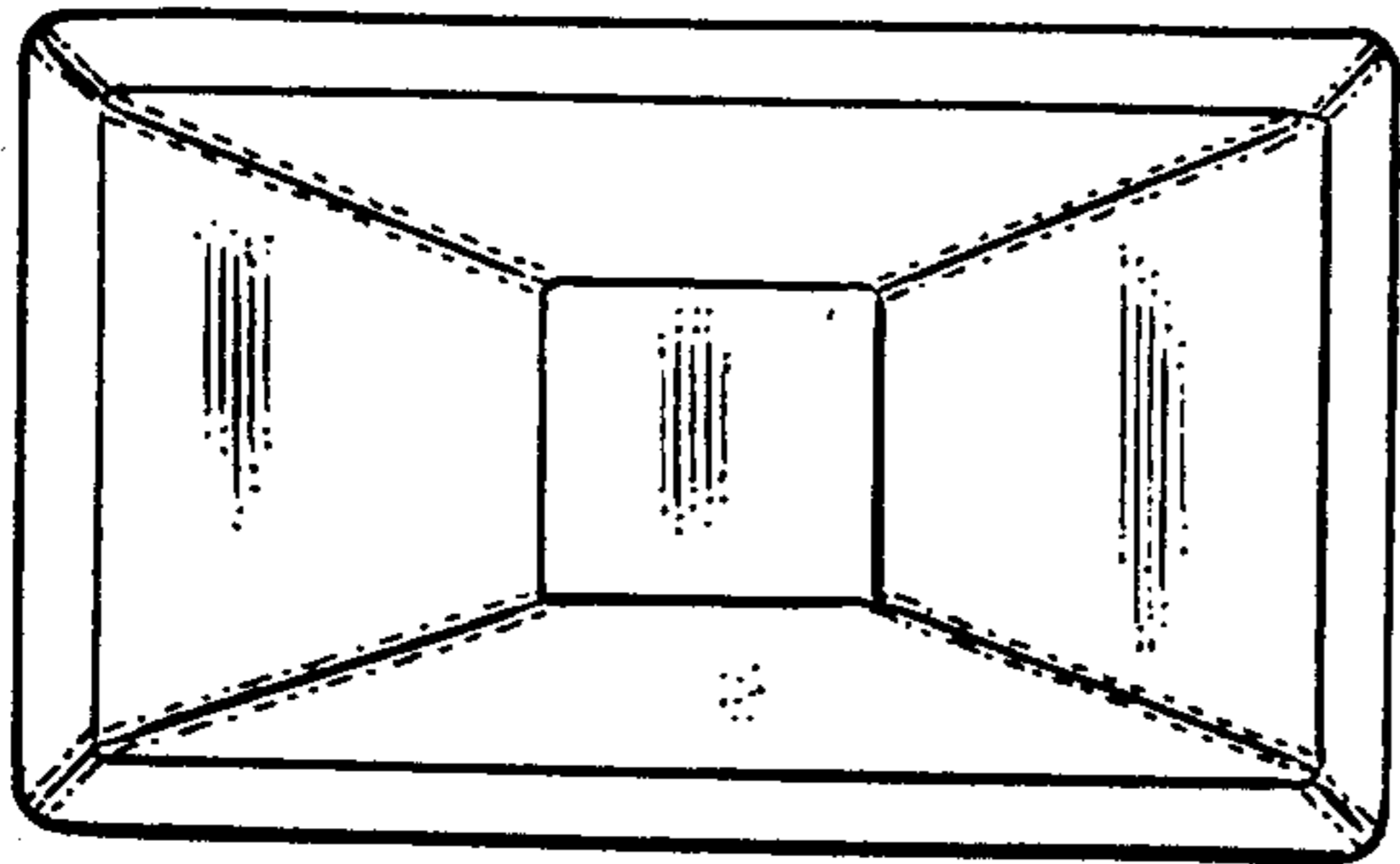
The ornamental design for a luminaire, as shown and described.

DESCRIPTION

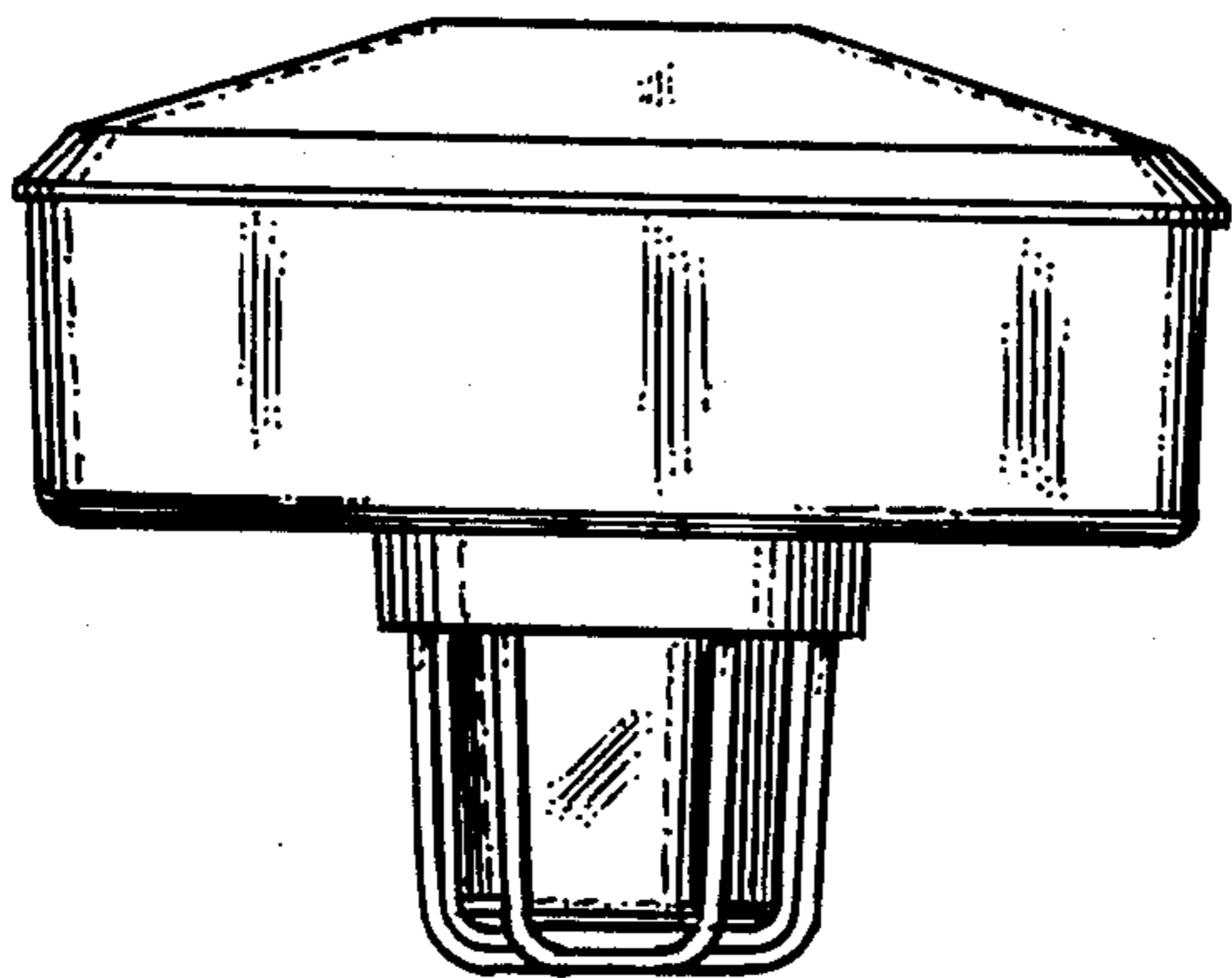
FIG. 1 is a side elevational view of a first embodiment of a luminaire embodying my new design;  
FIG. 2 is a top plan view thereof;  
FIG. 3 is a bottom plan view thereof;  
FIG. 4 is an end elevational view thereof;  
FIGS. 5, 6, 7 and 8 are corresponding views of a second embodiment of my design;  
FIGS. 9, 10, 11 and 12 are corresponding views of a third embodiment of my design;  
FIGS. 13, 14, 15 and 16 are corresponding views of a fourth embodiment of my design;  
FIGS. 17, 18, 19 and 20 are corresponding views of a fifth embodiment of my design;  
FIGS. 21, 22, 23 and 24 are corresponding views of a sixth embodiment of my design;  
FIGS. 25, 26, 27 and 28 are corresponding views of a seventh embodiment of my design; and  
FIGS. 29, 30, 31 and 32 are corresponding views of an eighth embodiment of my design.



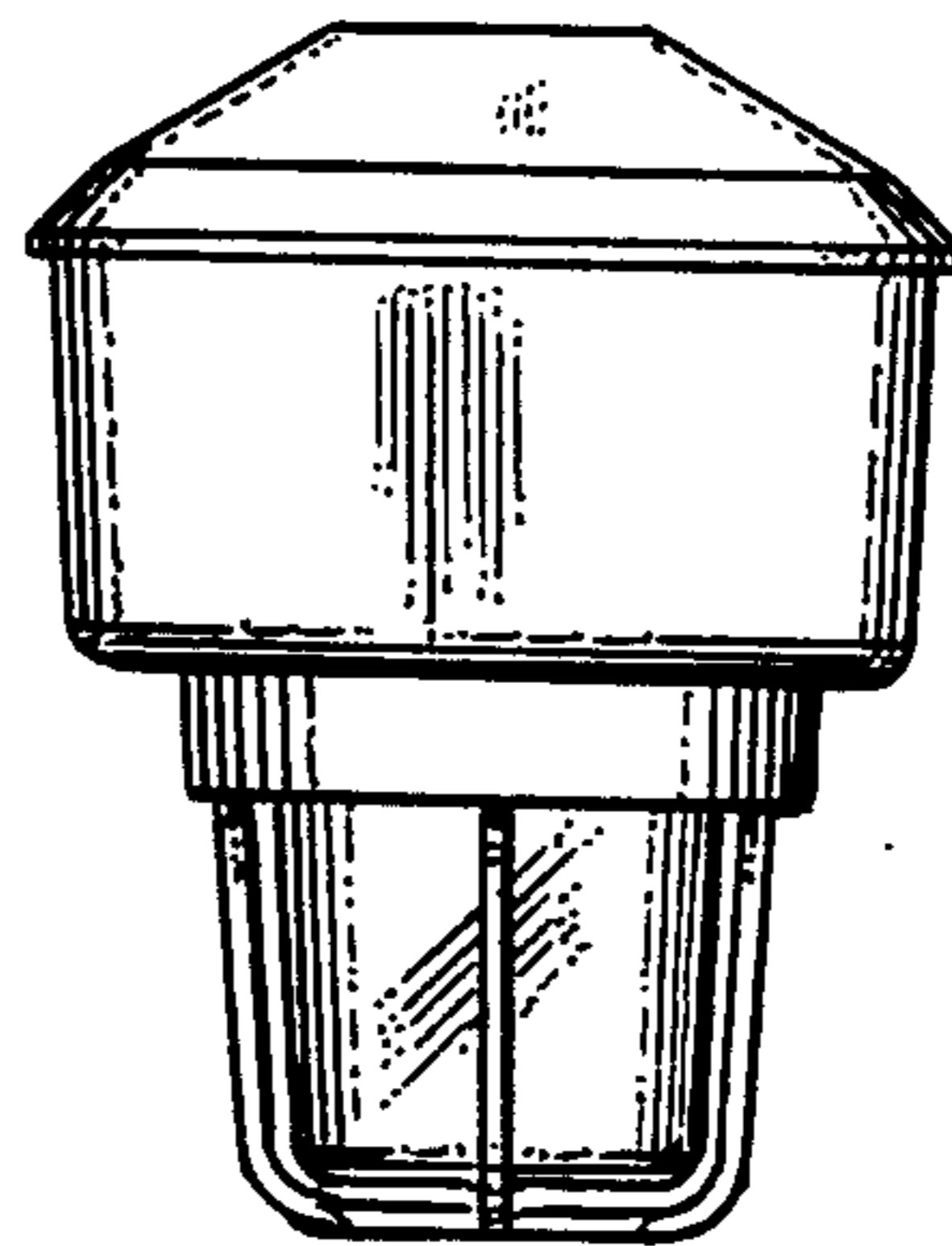
*Fig. 2.*



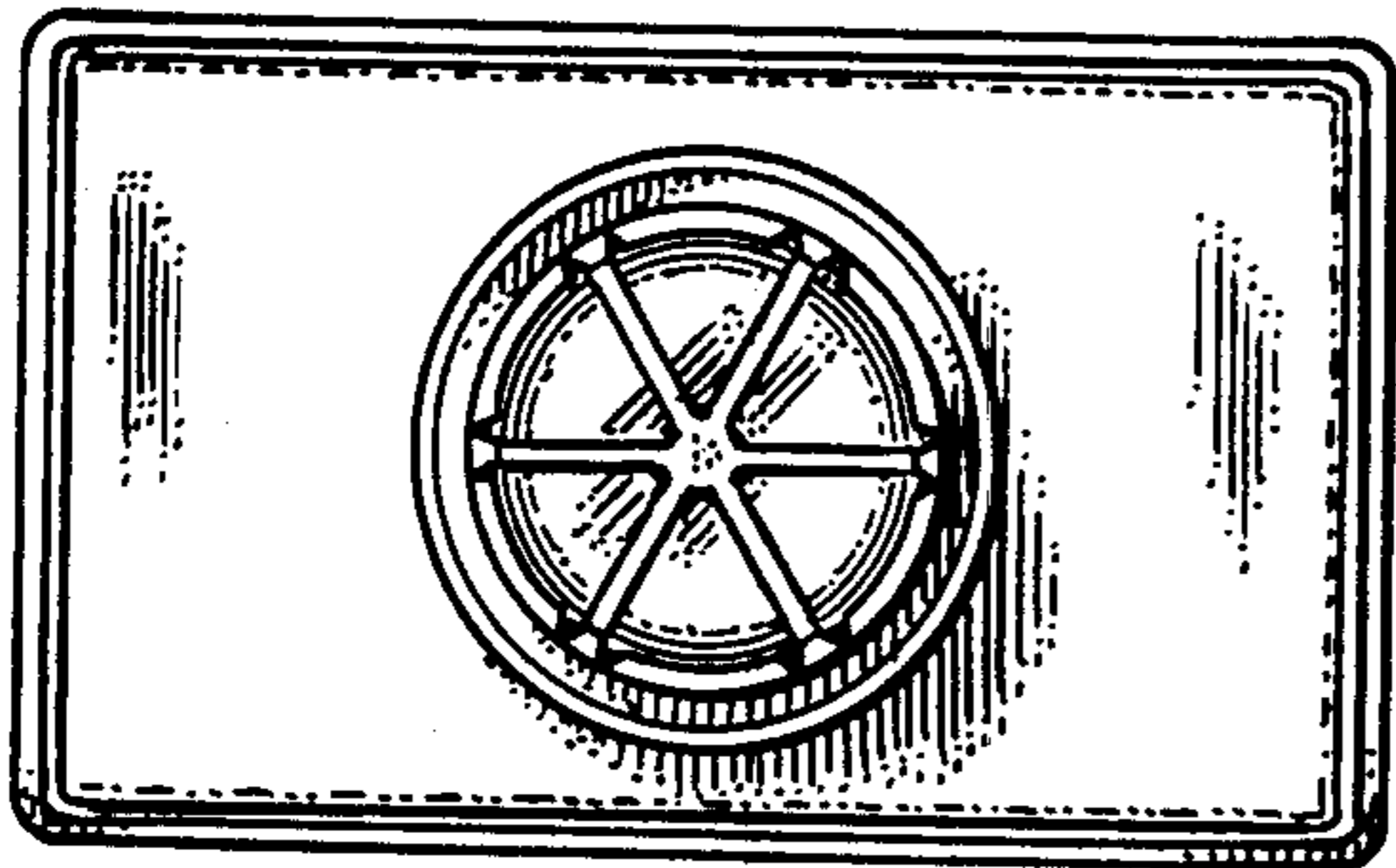
*Fig. 1.*



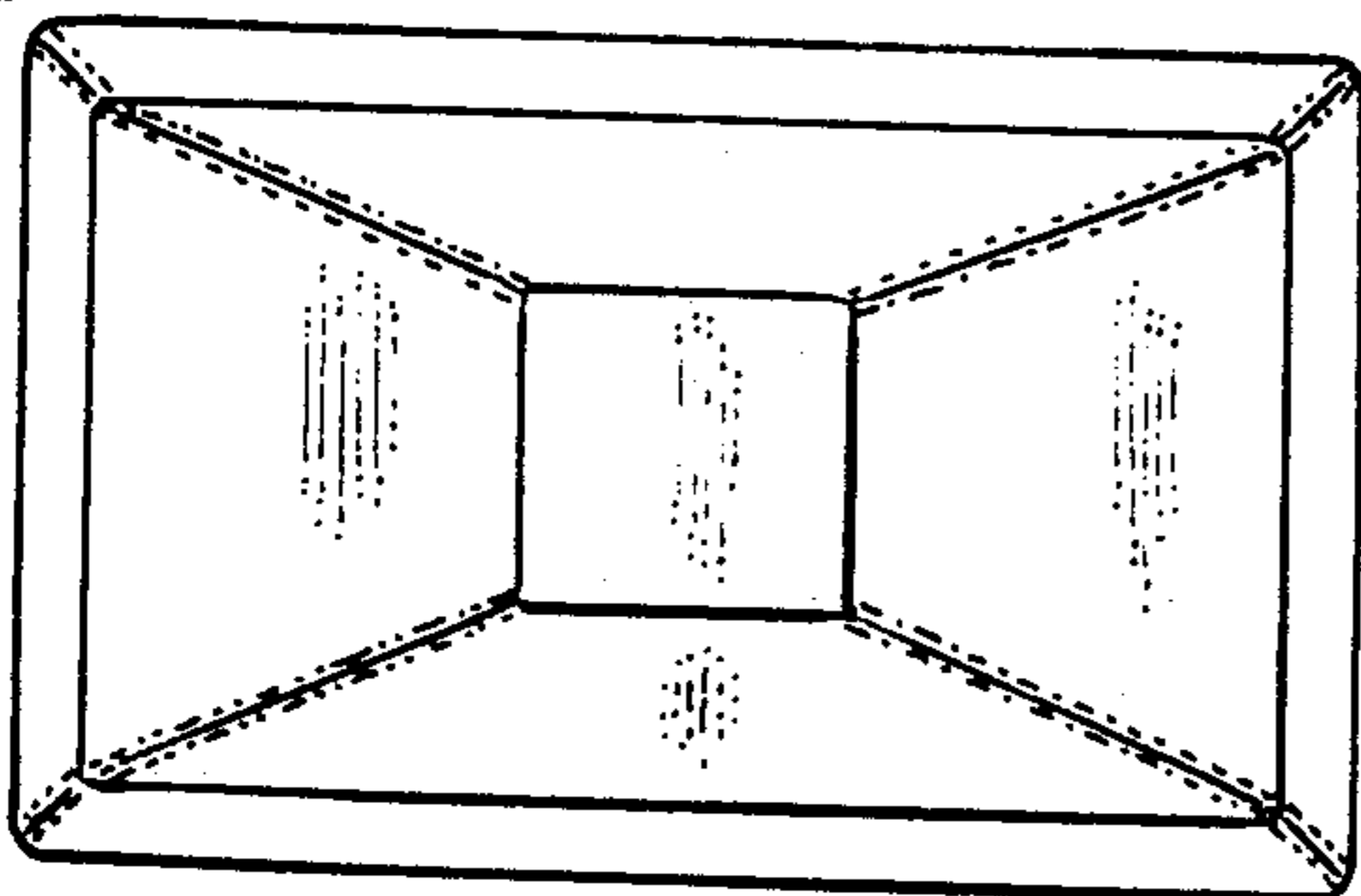
*Fig. 4.*



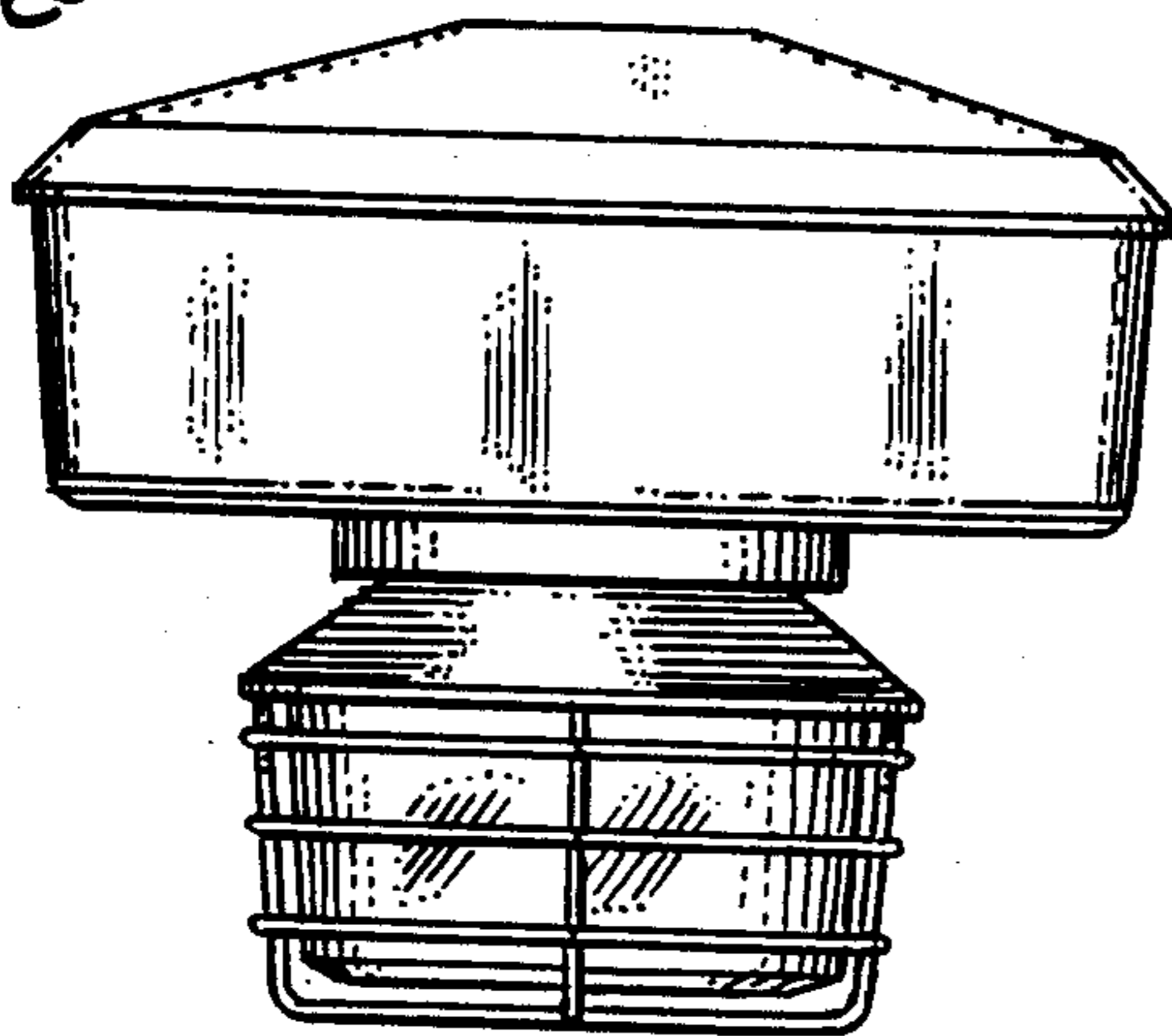
*Fig. 3.*



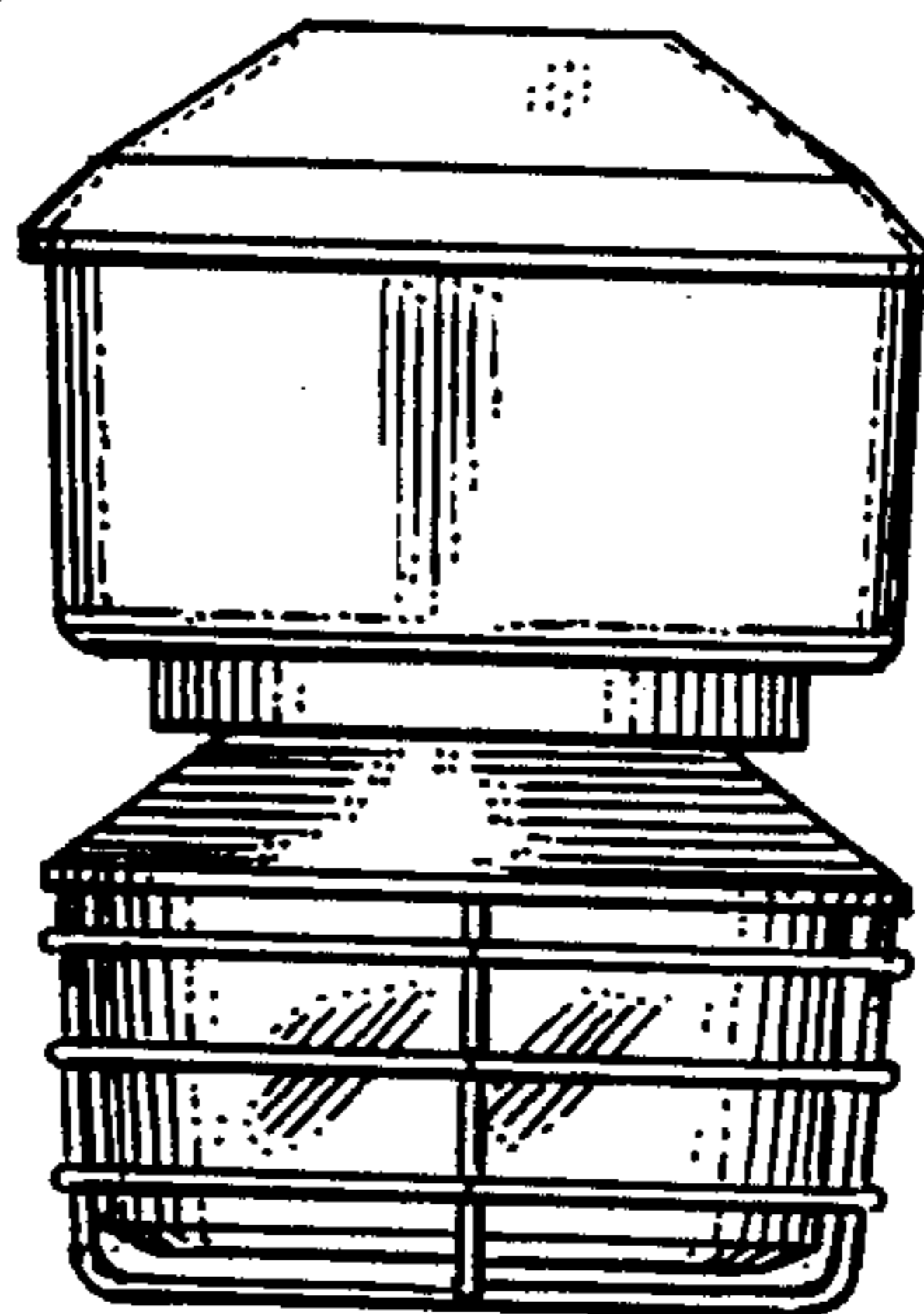
*Fig. 6.*



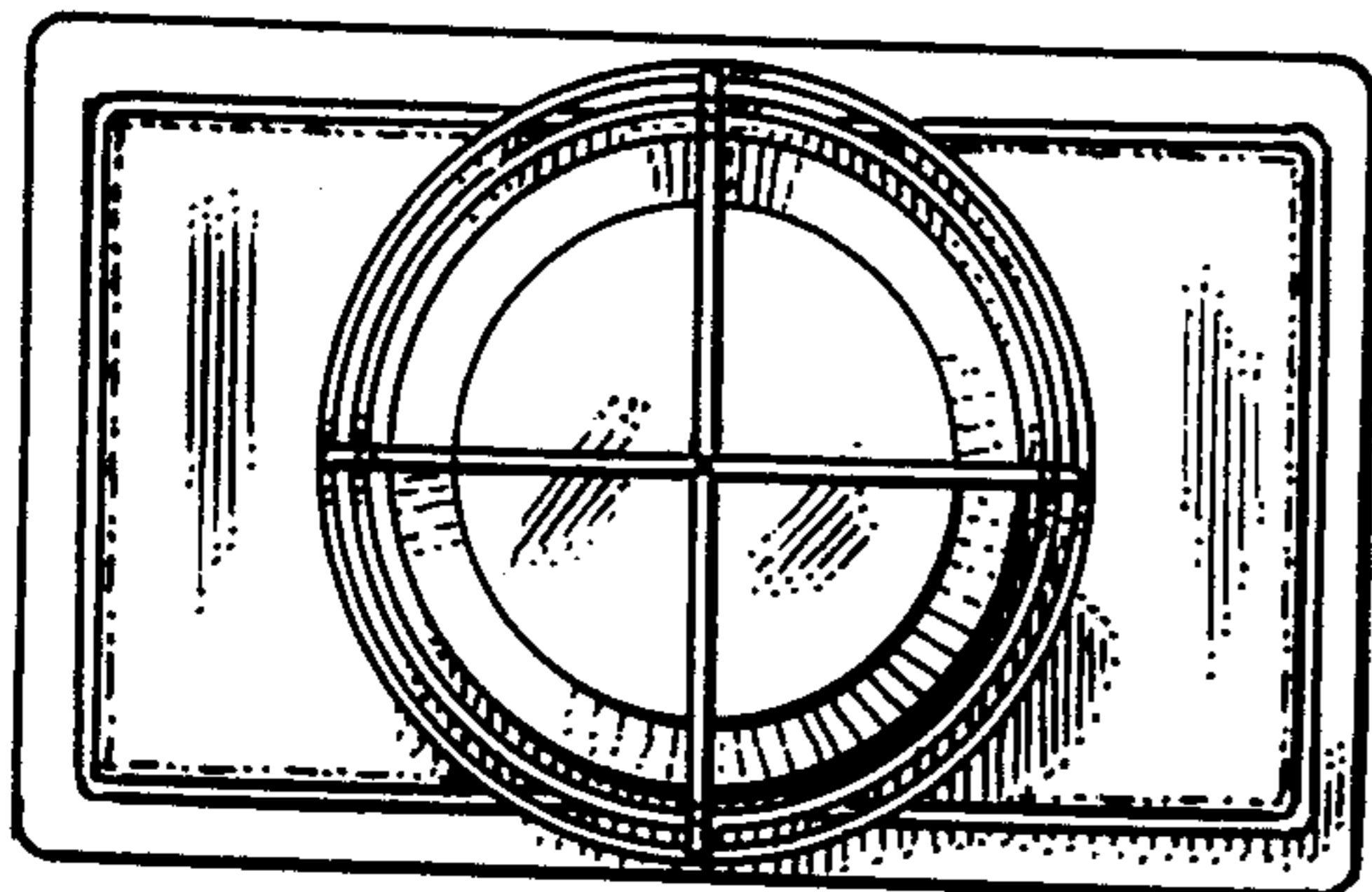
*Fig. 5.*



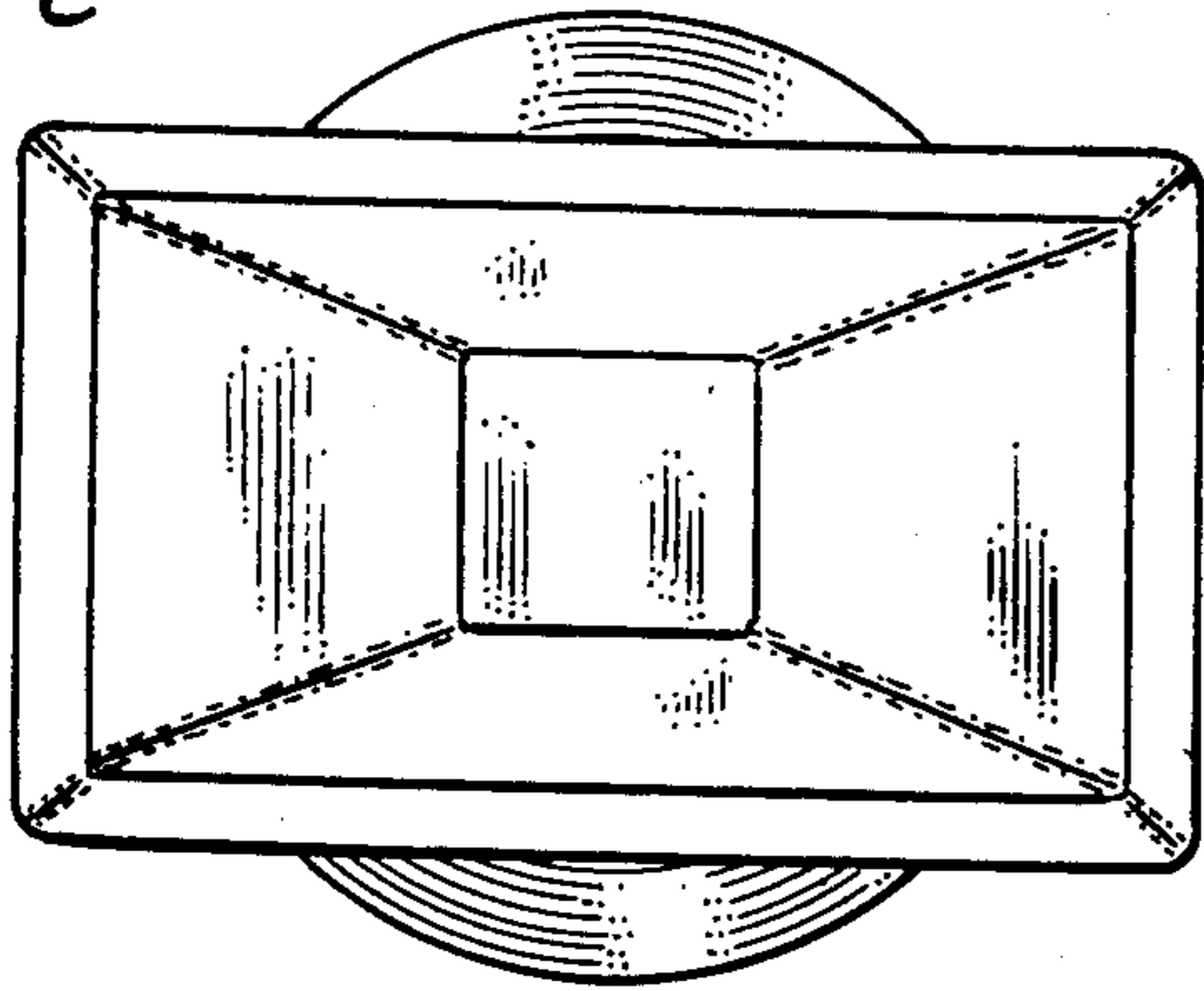
*Fig. 8.*



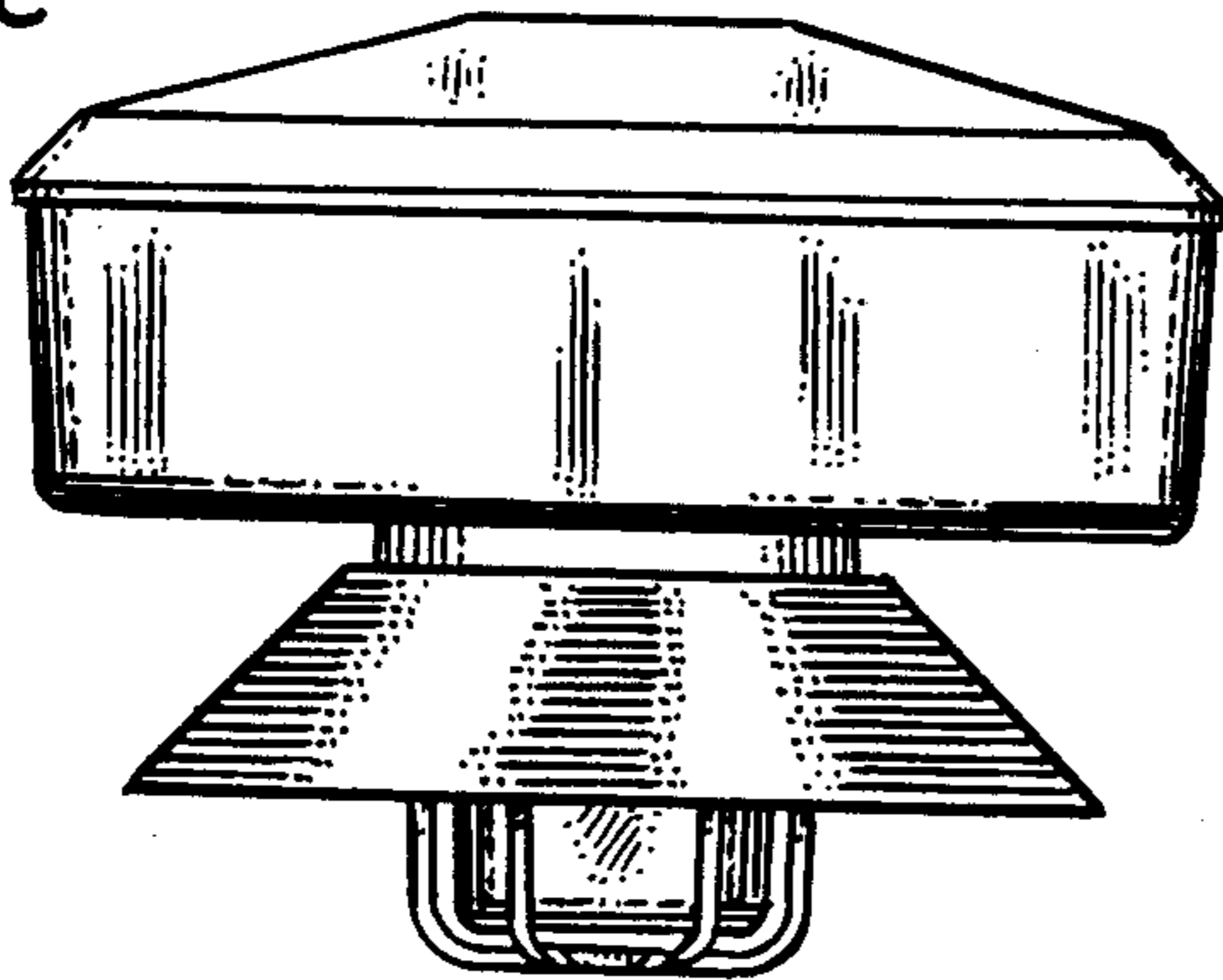
*Fig. 7.*



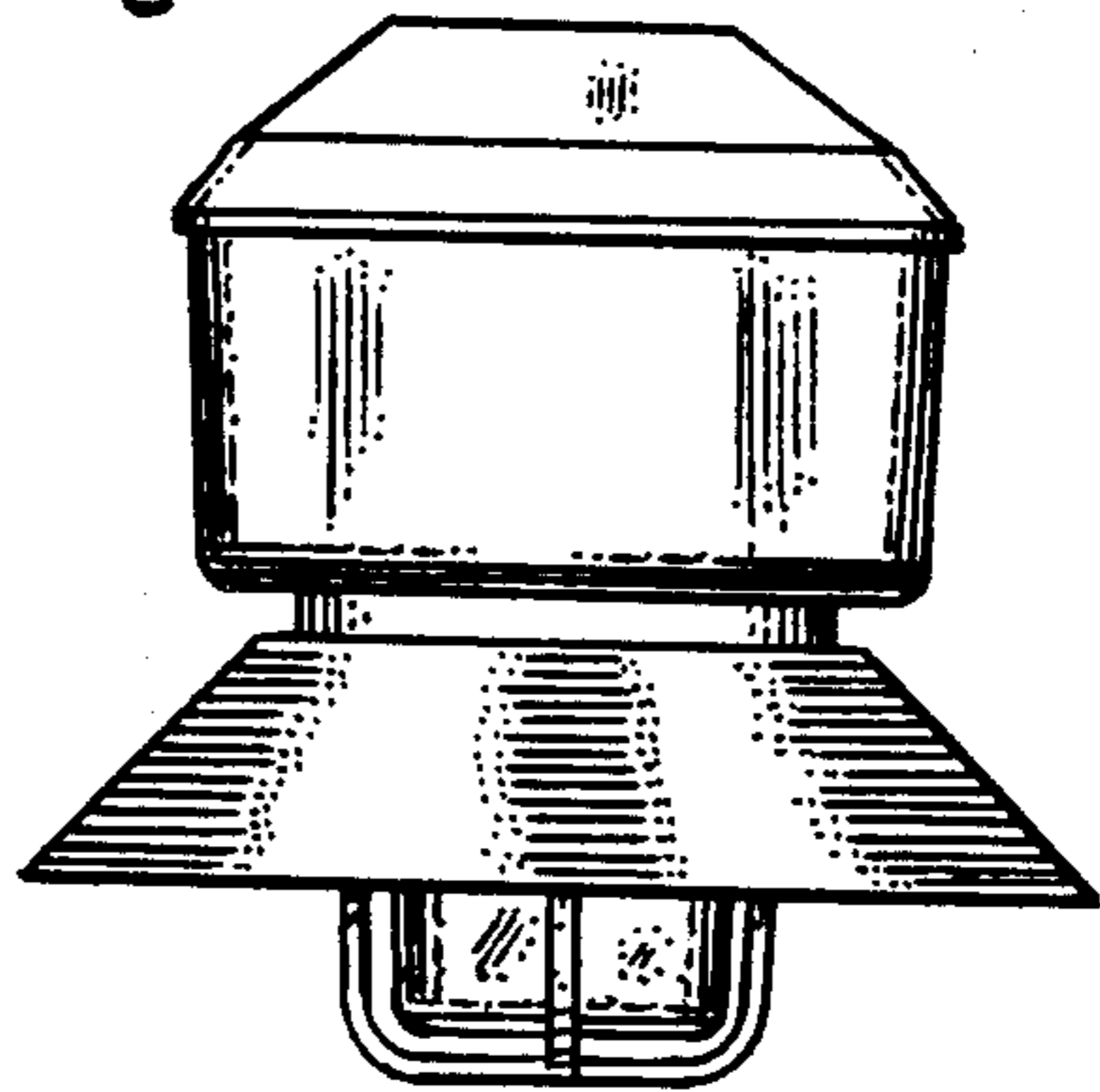
*Fig. 10.*



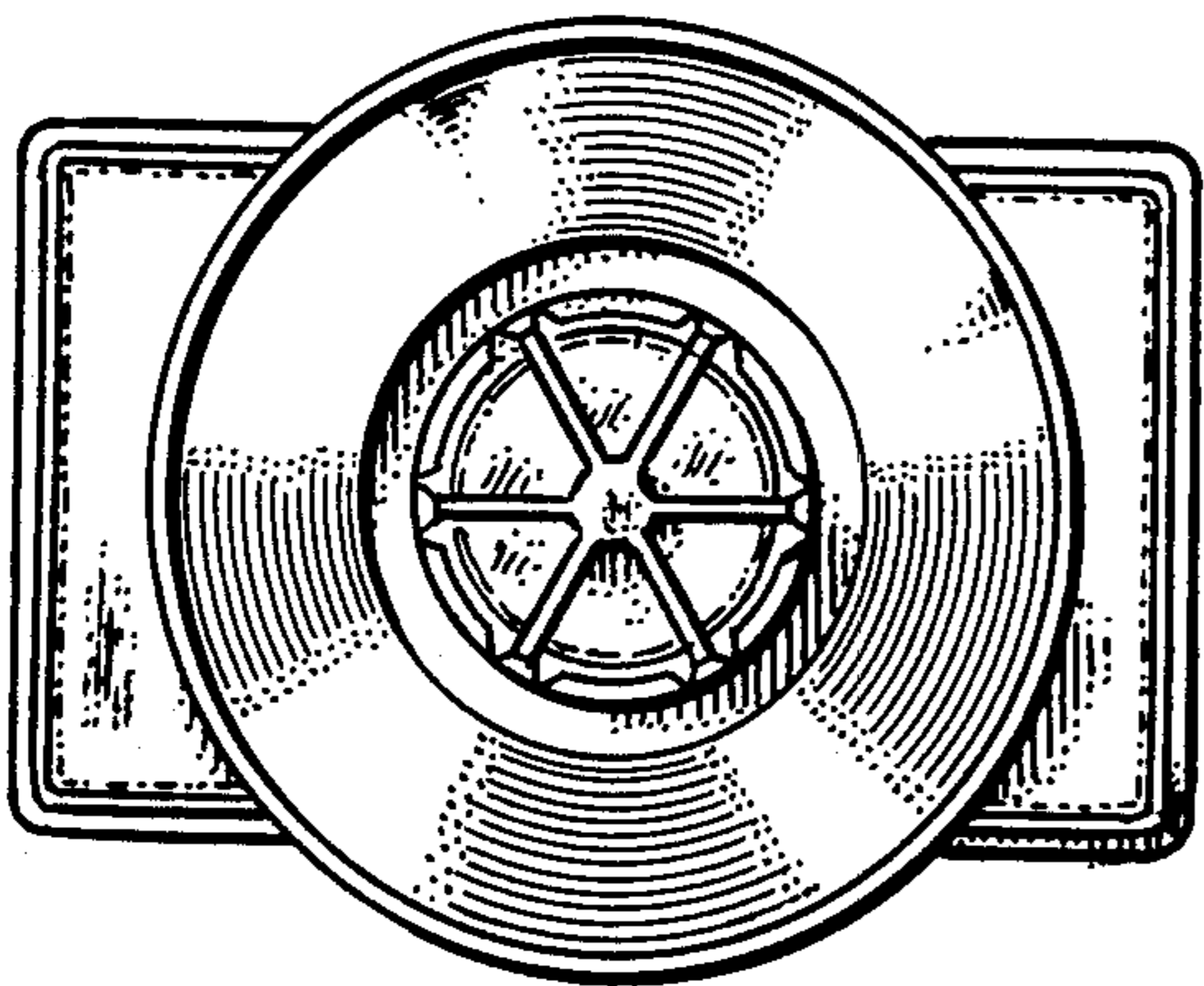
*Fig. 9.*



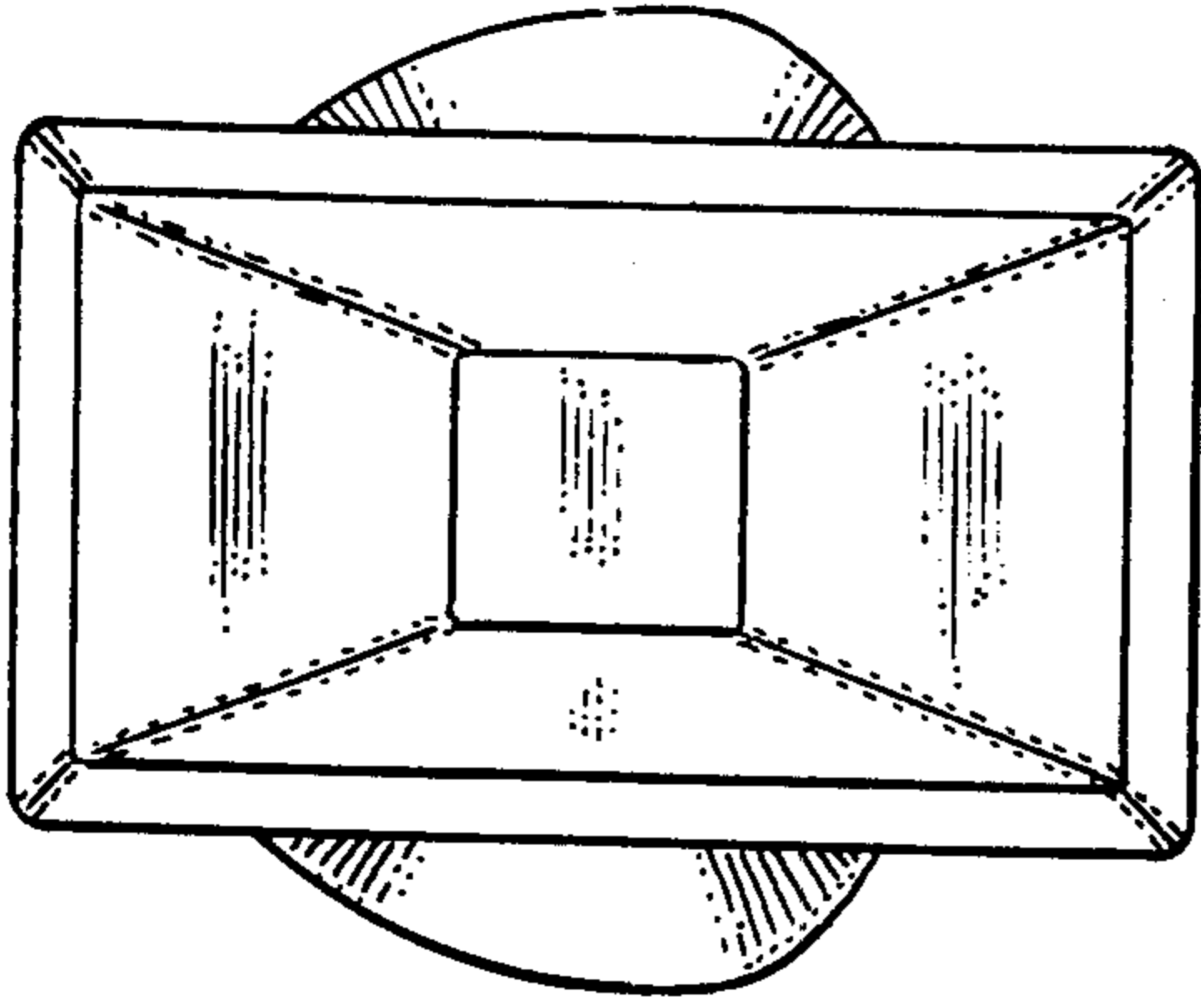
*Fig. 12.*



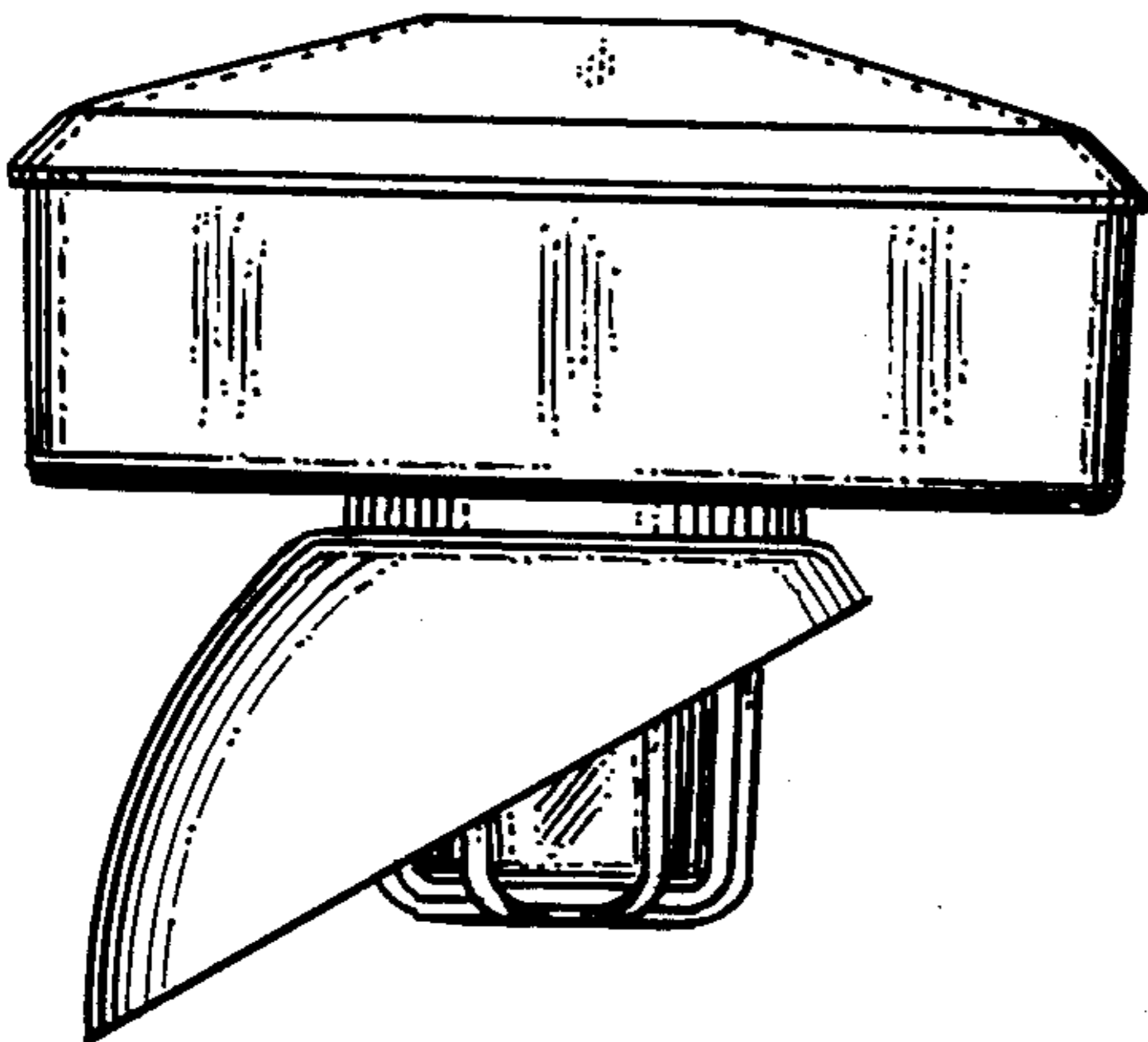
*Fig. 11.*



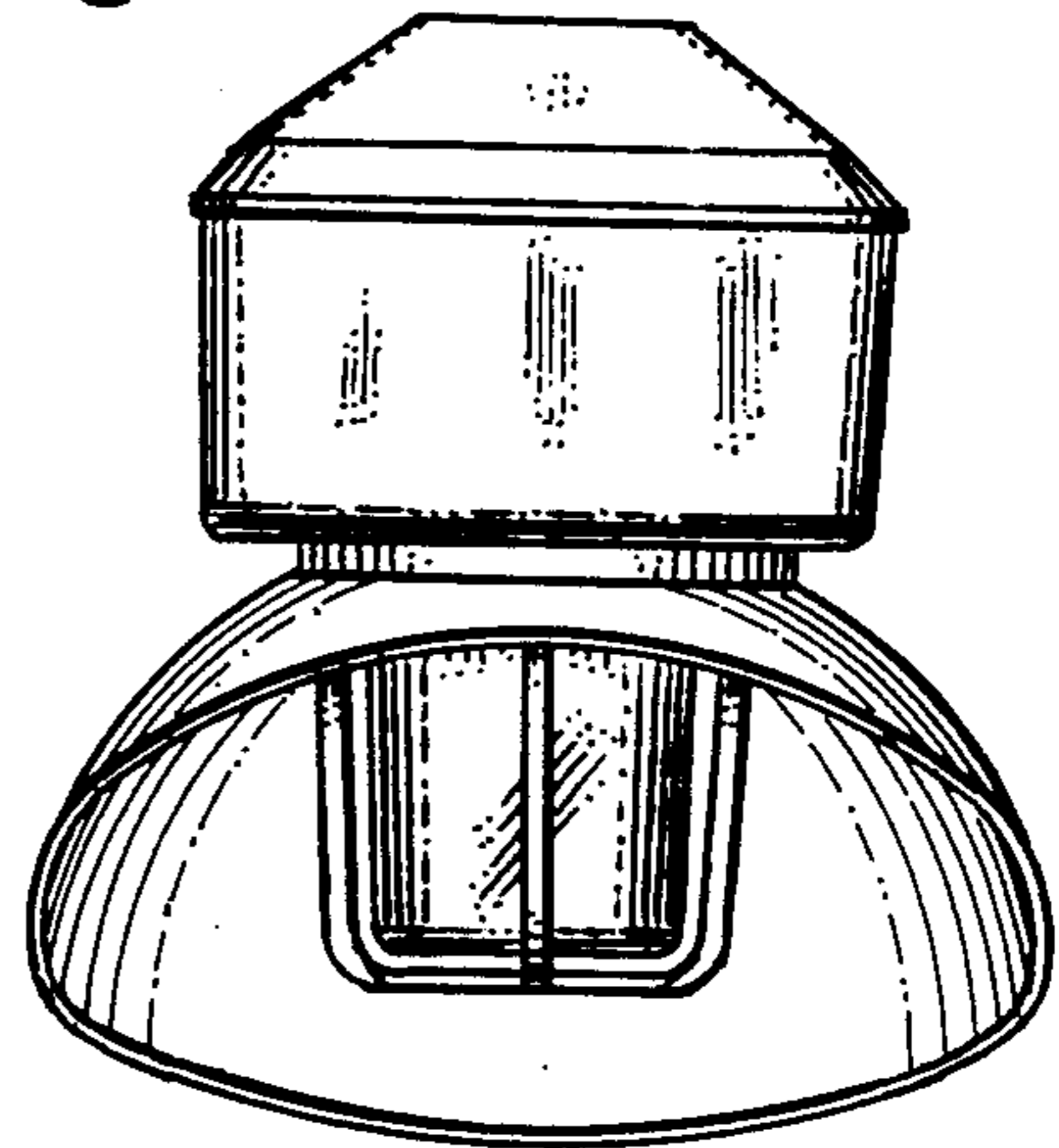
*Fig. 14.*



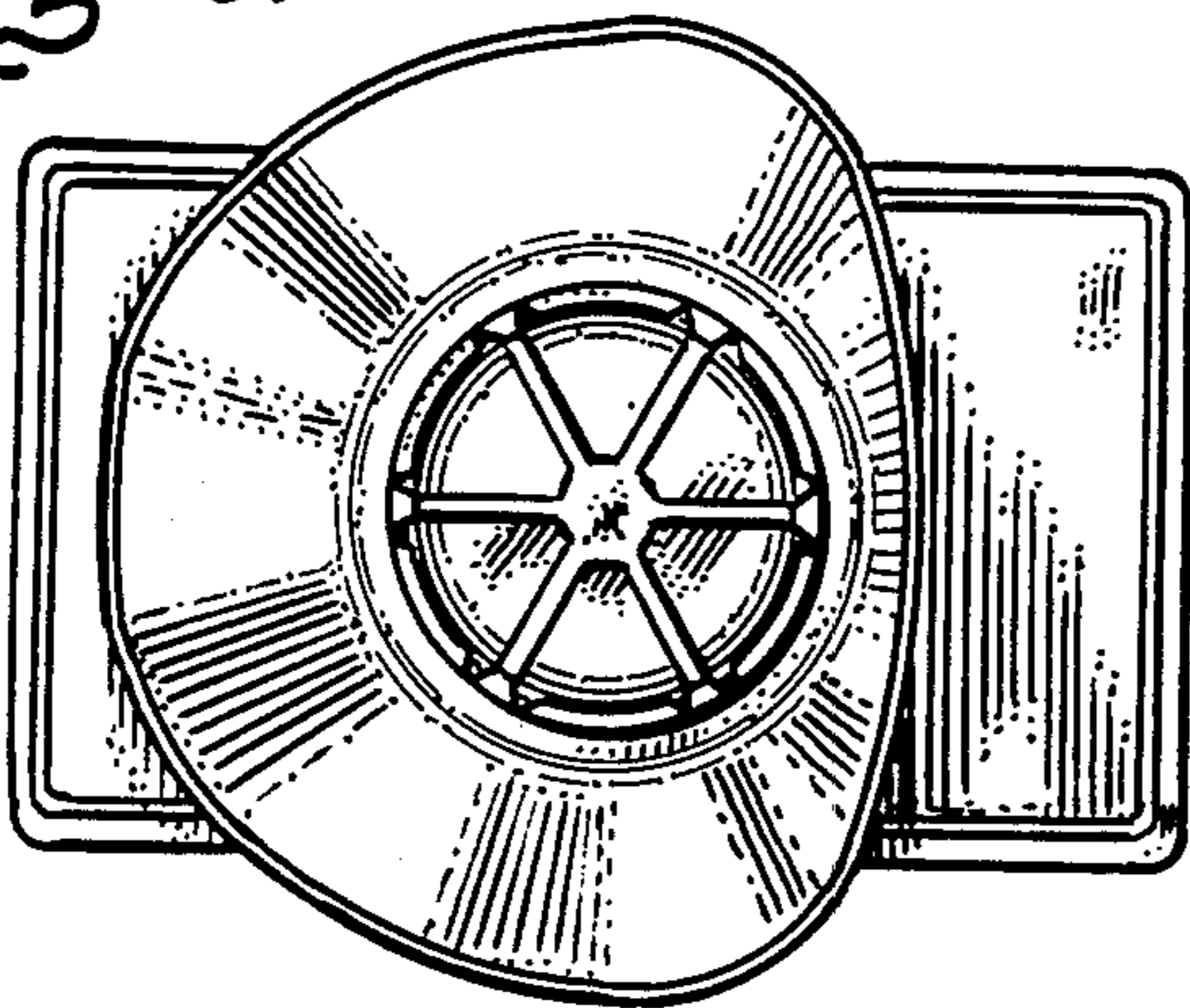
*Fig. 13.*



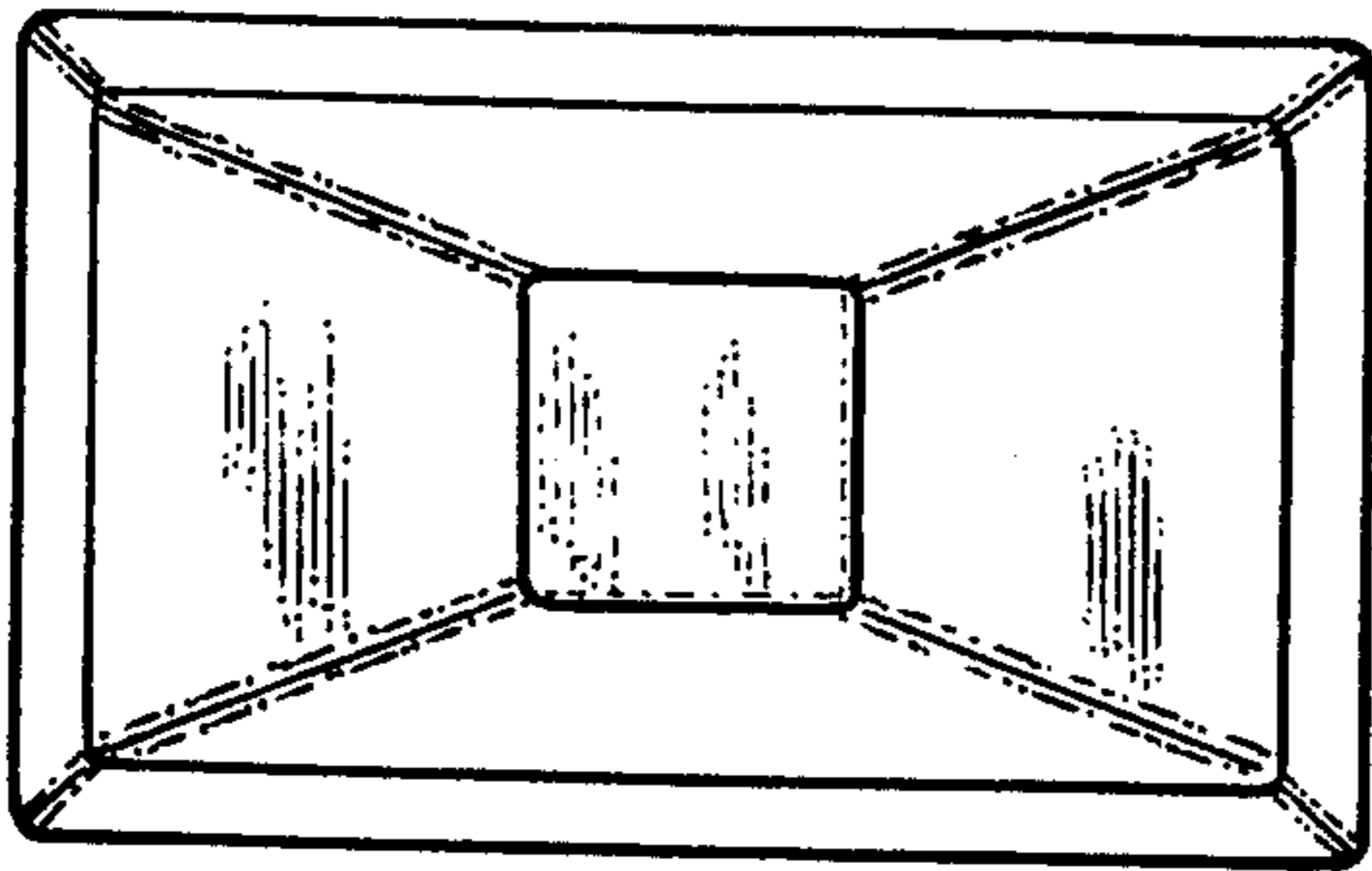
*Fig. 16.*



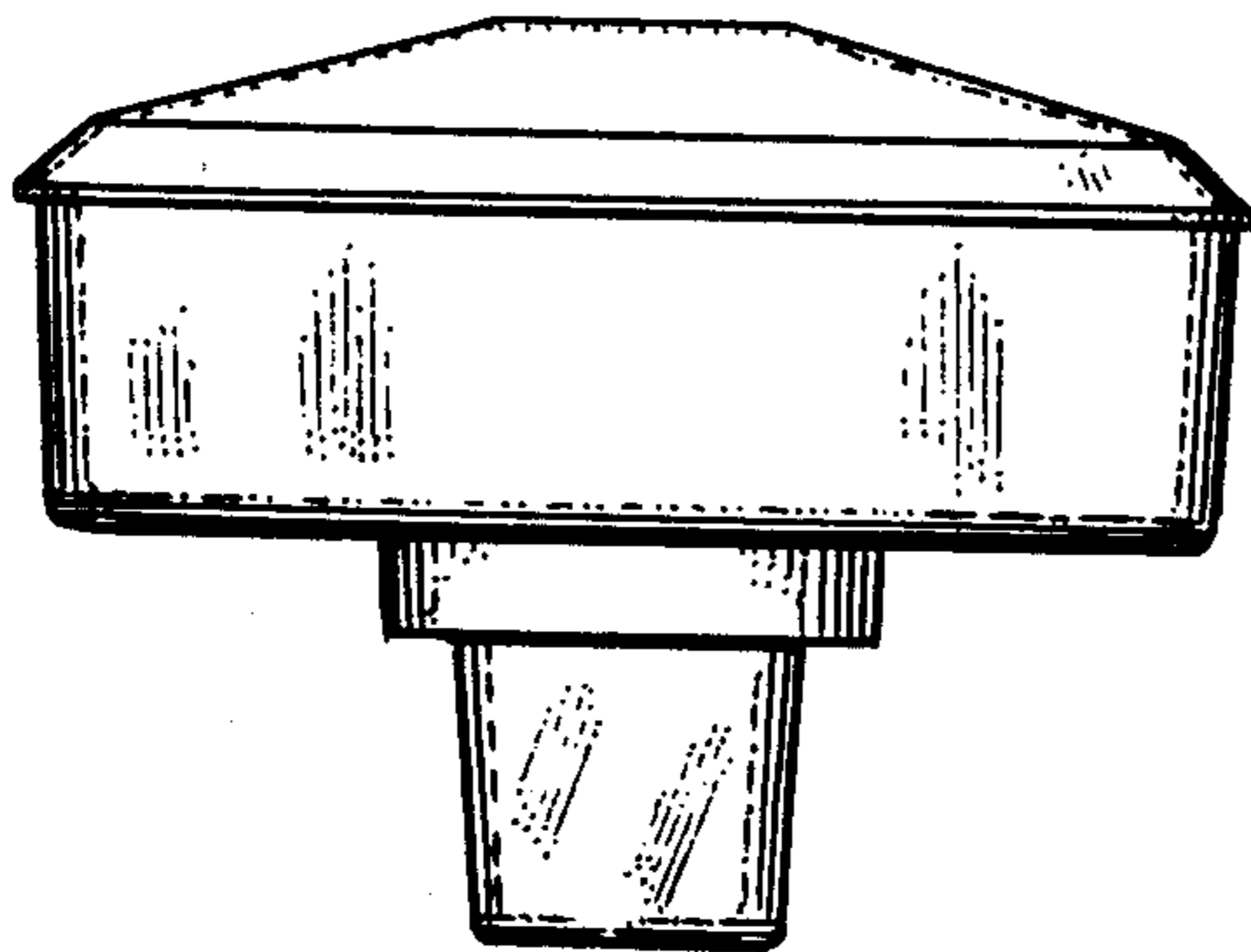
*Fig. 15.*



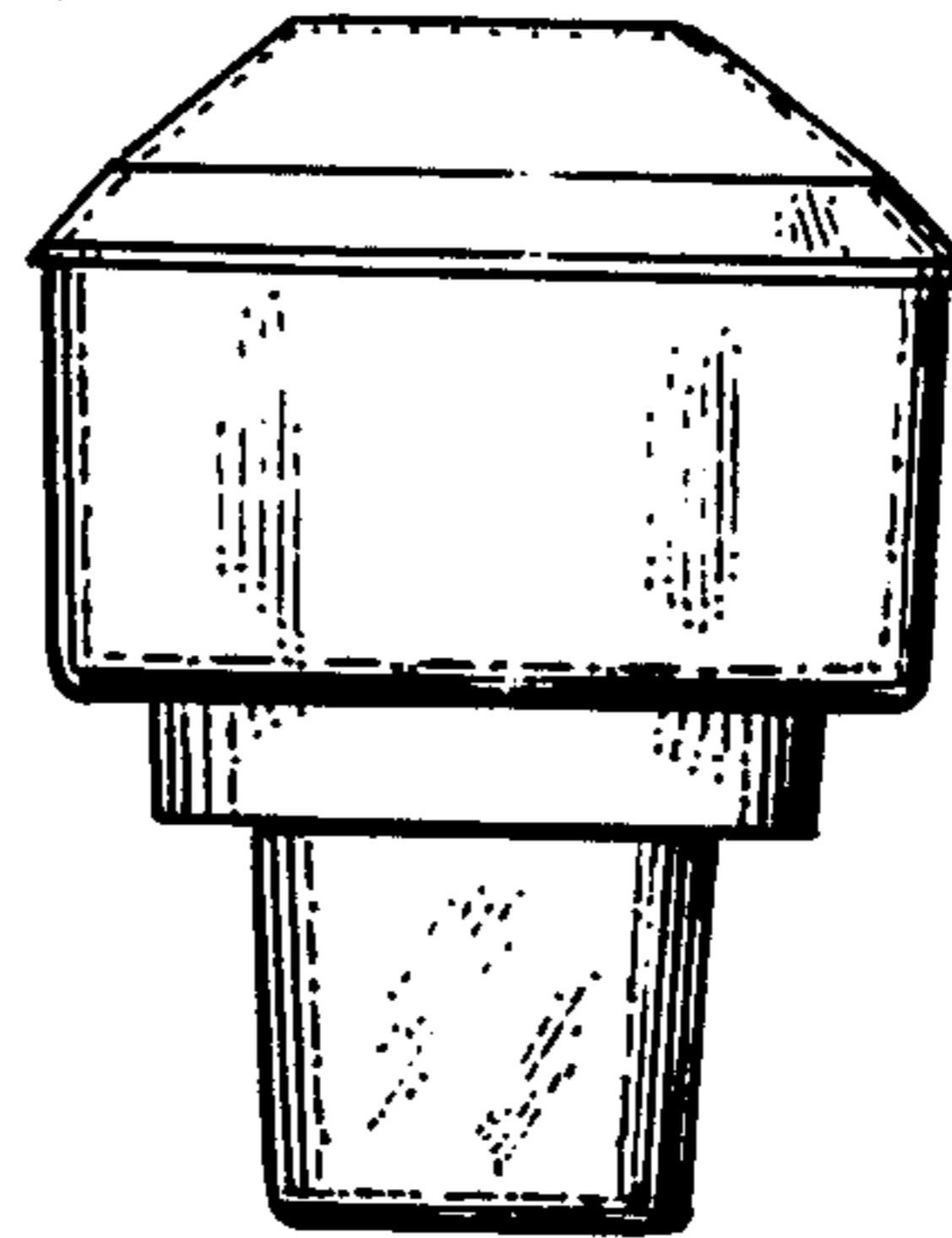
*Fig. 18.*



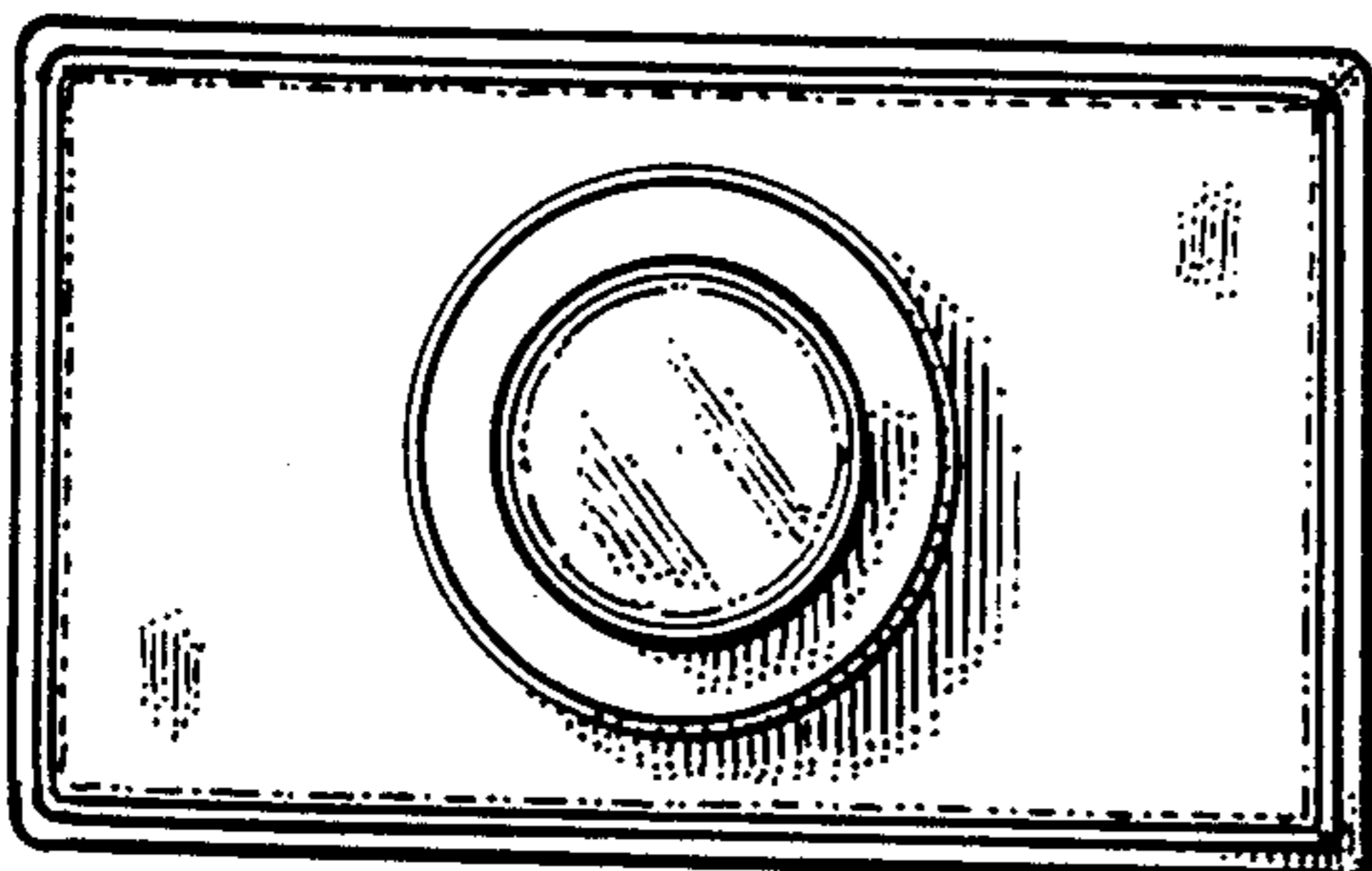
*Fig. 17.*



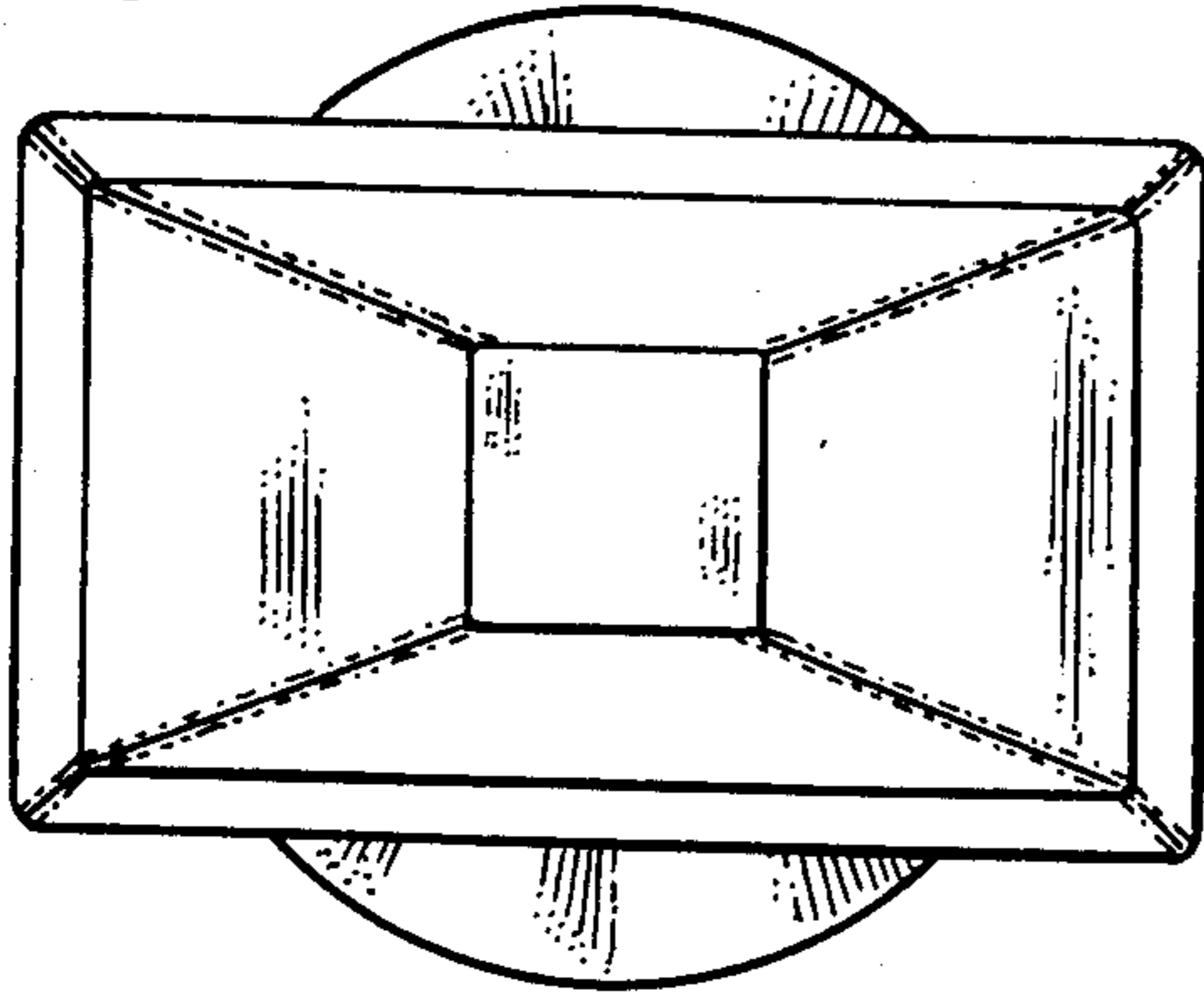
*Fig. 20.*



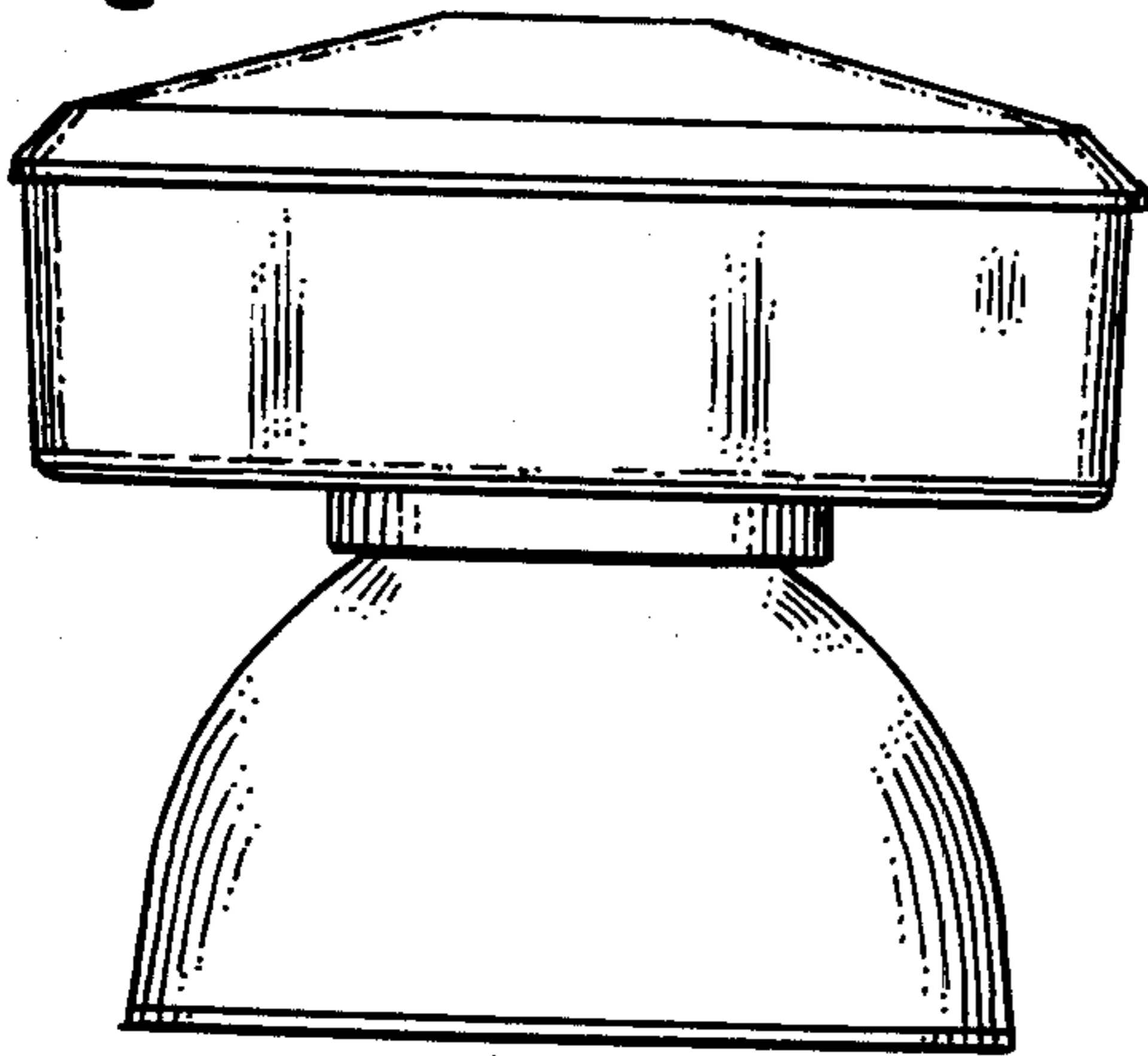
*Fig. 19.*



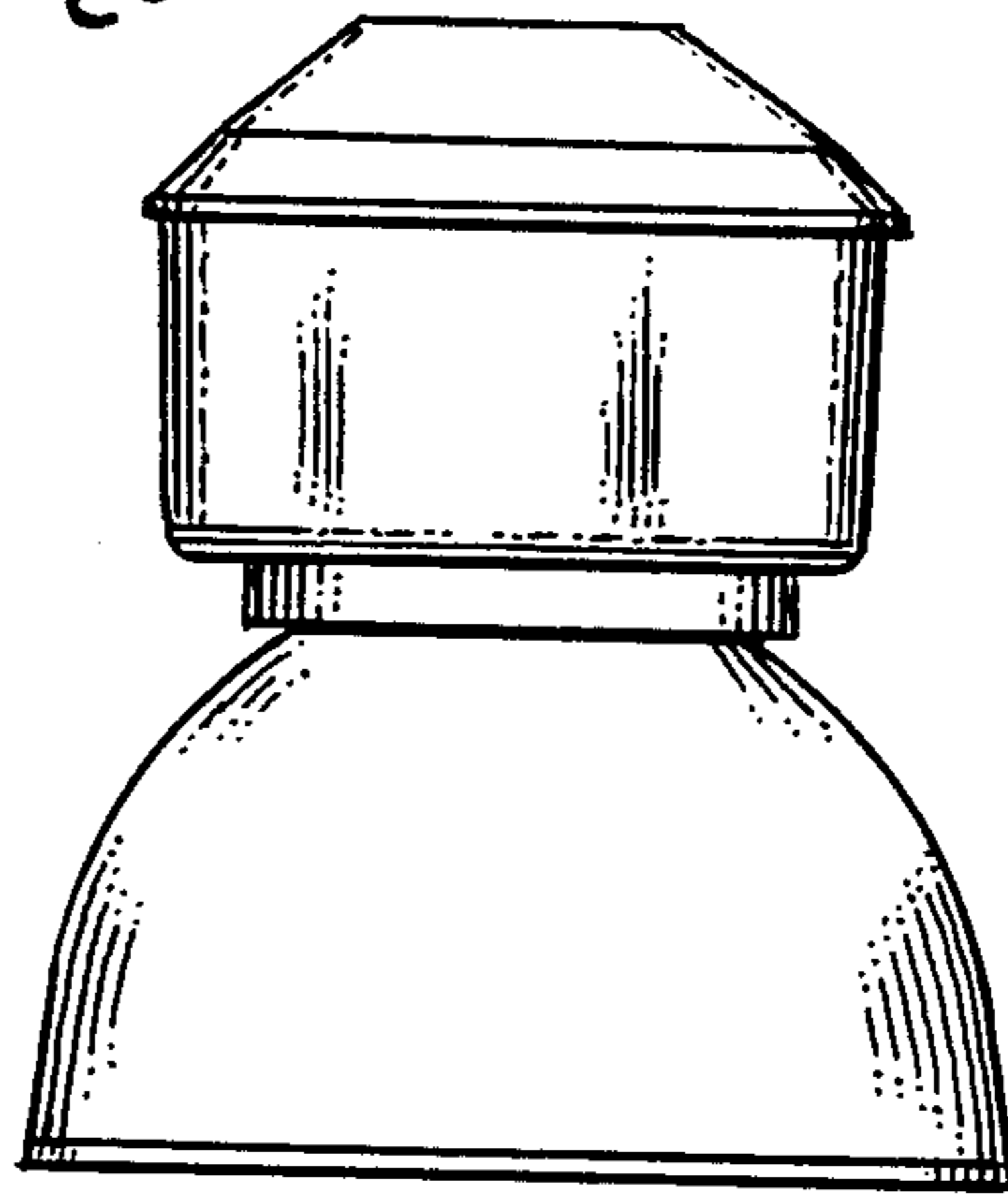
*Fig. 22.*



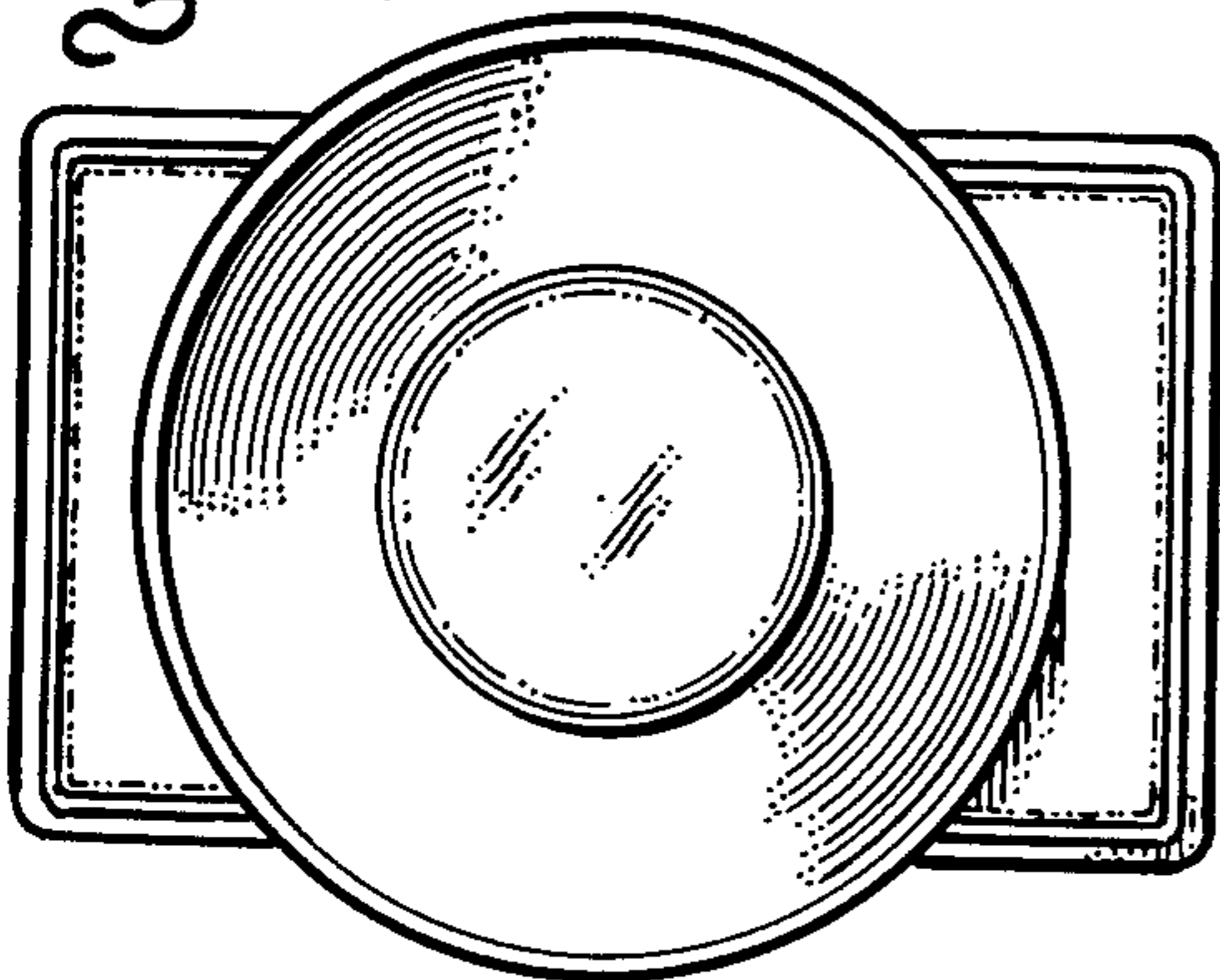
*Fig. 21.*



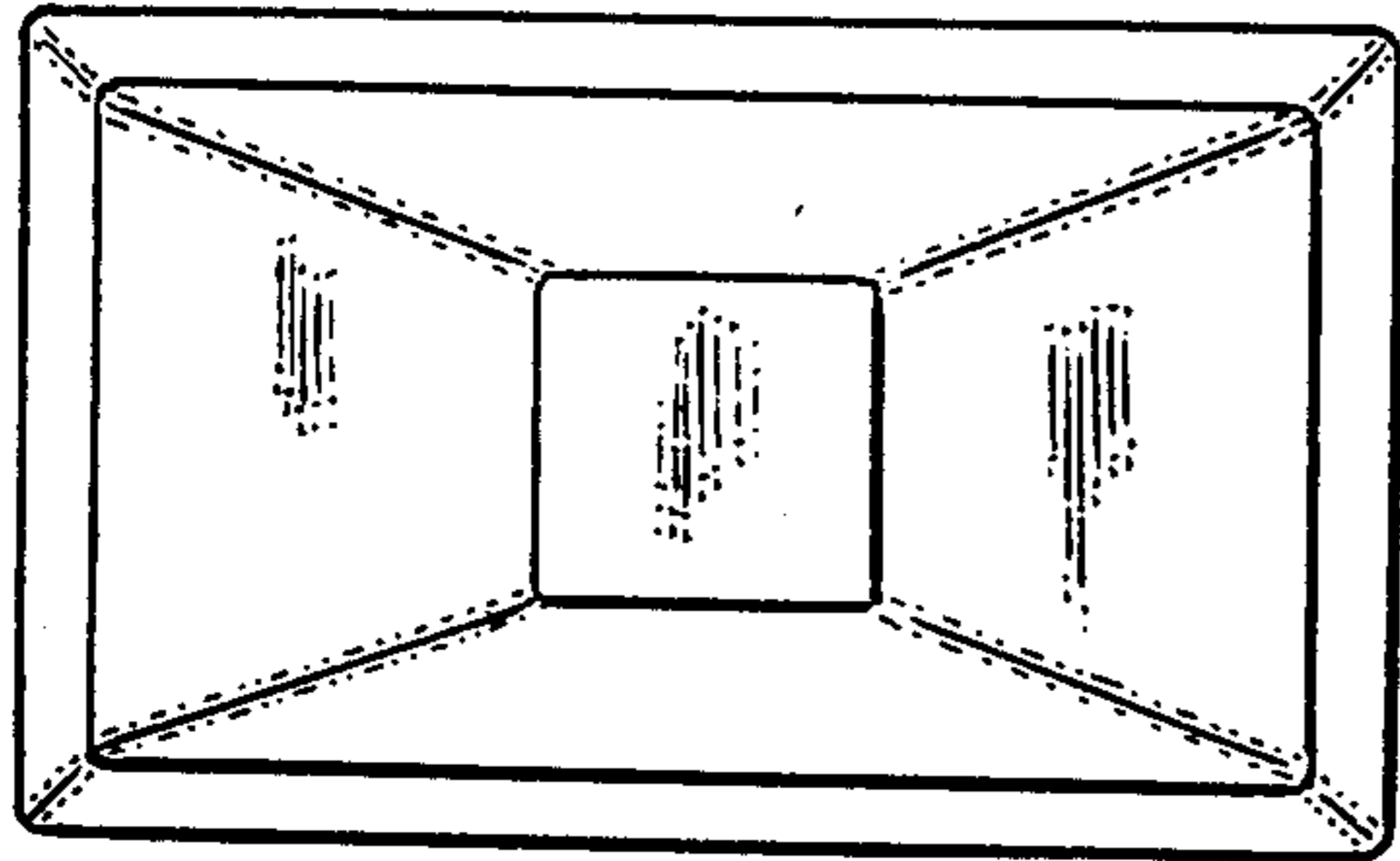
*Fig. 24.*



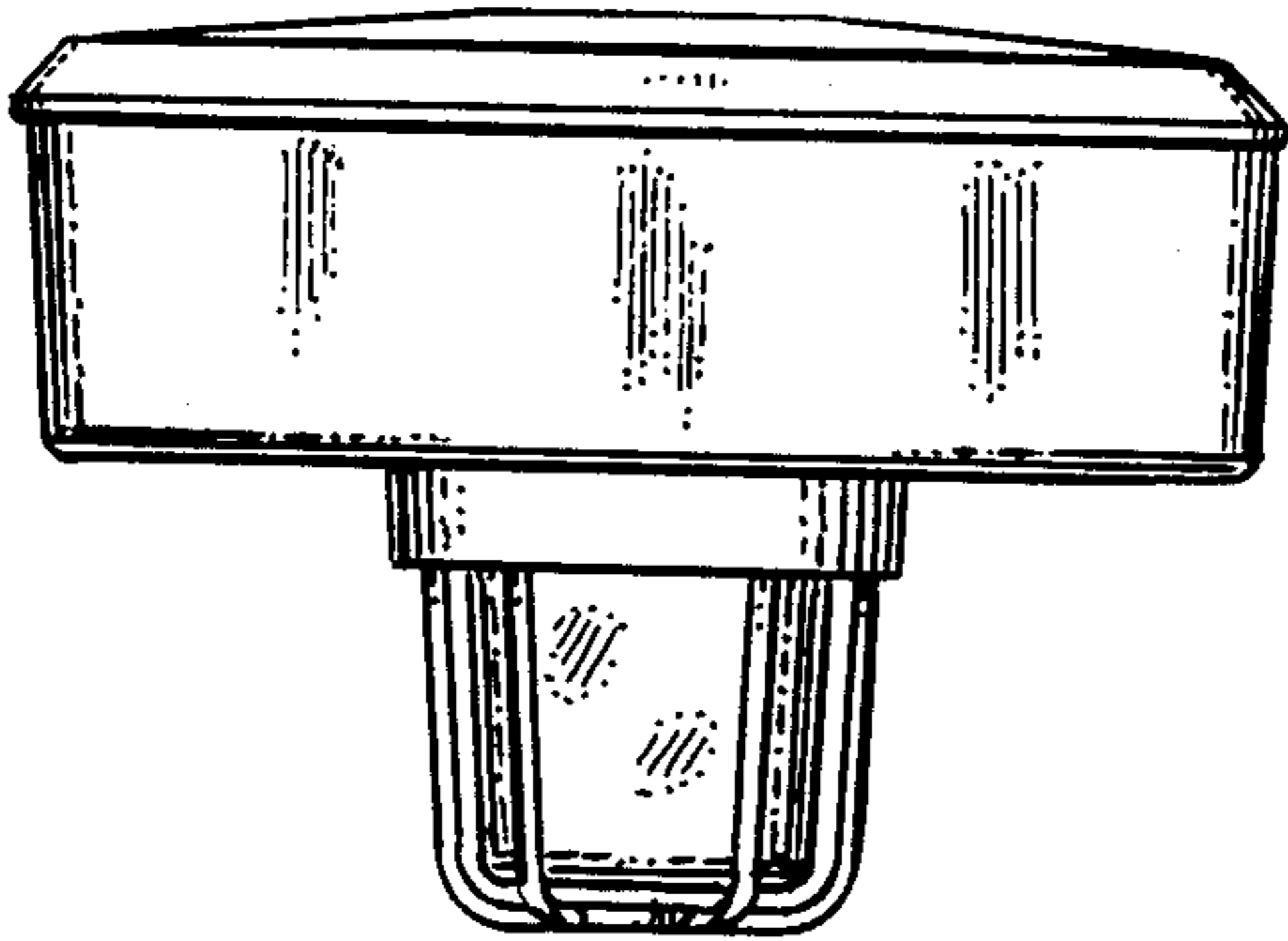
*Fig. 23.*



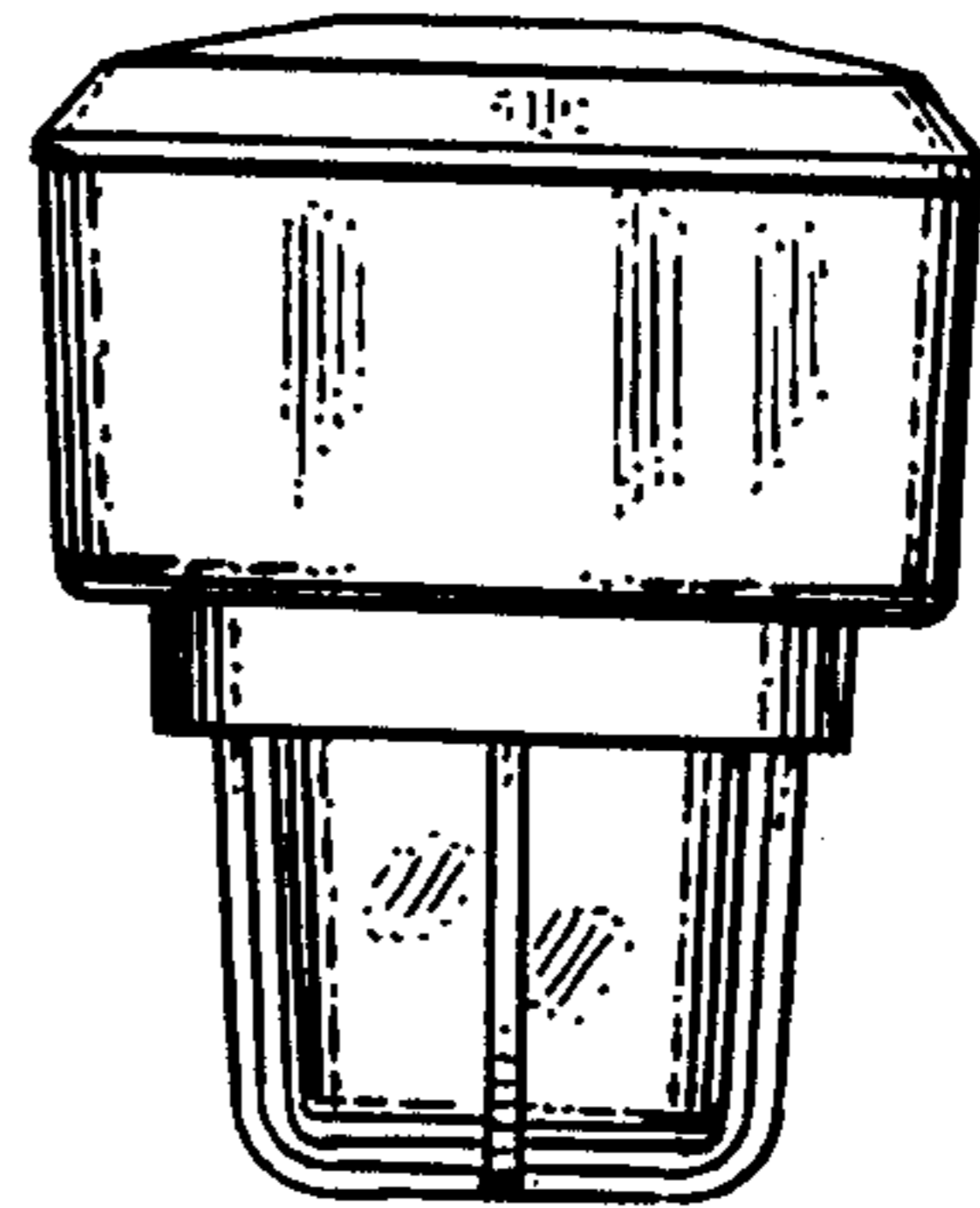
*Fig. 26.*



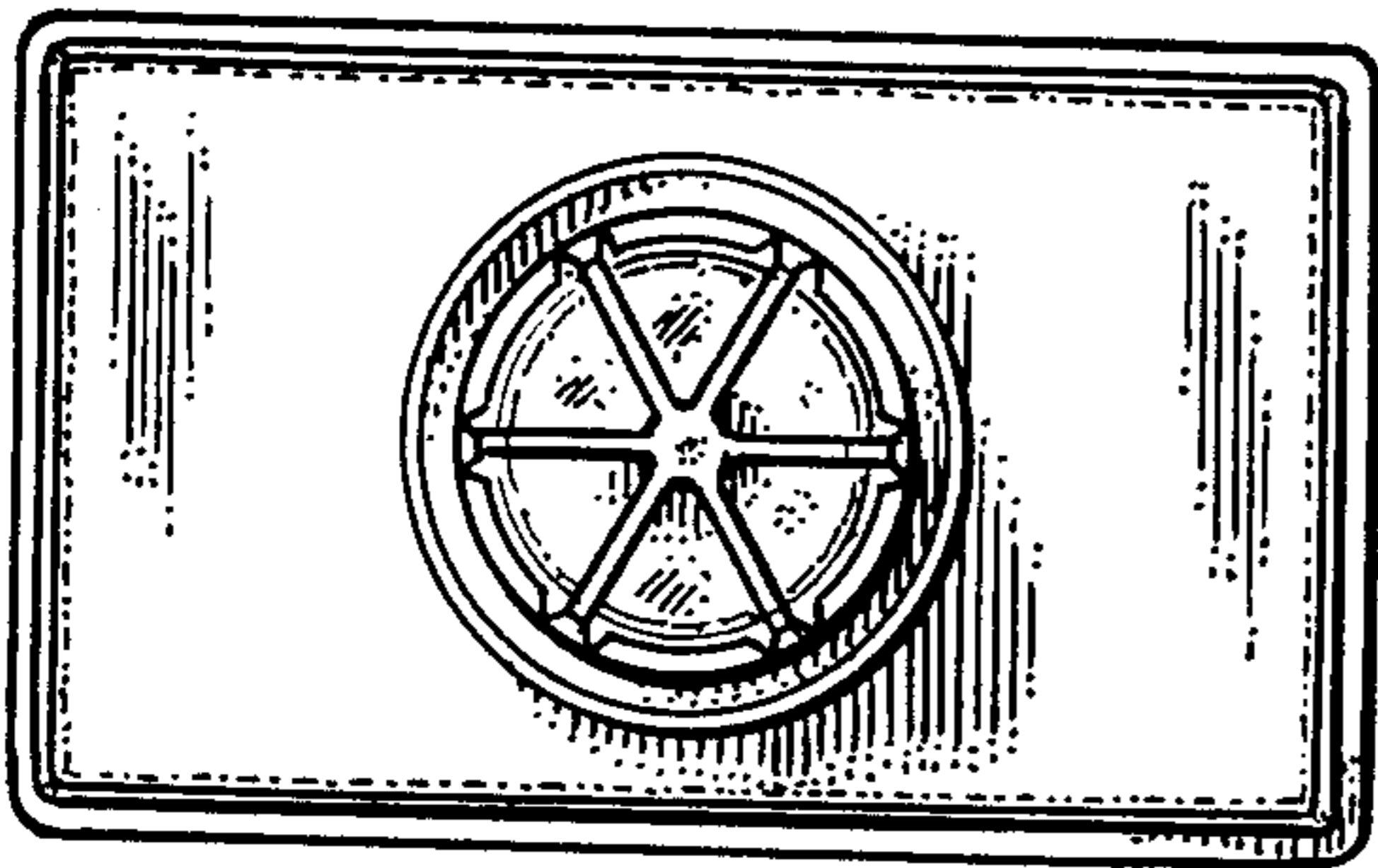
*Fig. 25.*



*Fig. 28.*

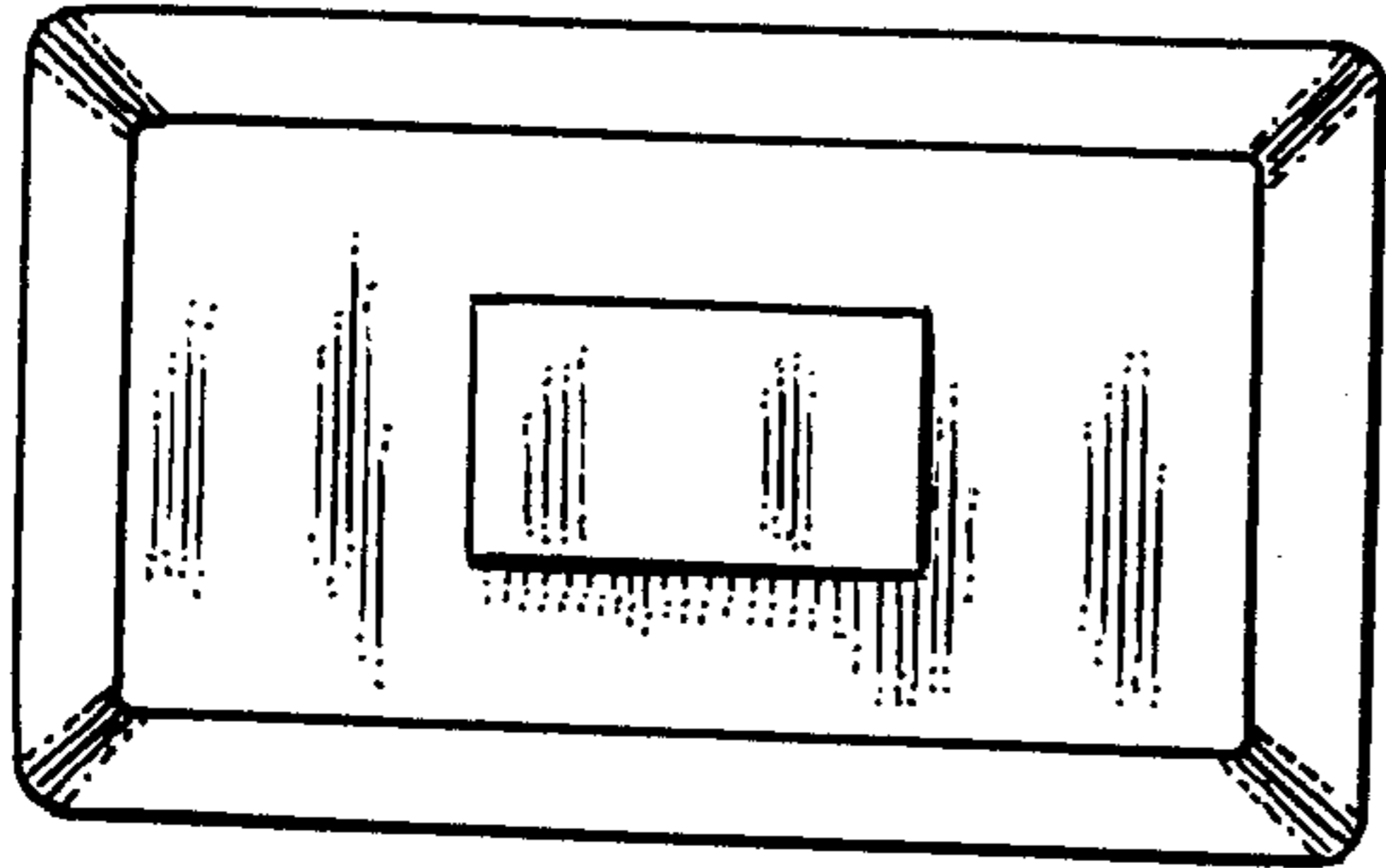


*Fig. 27.*

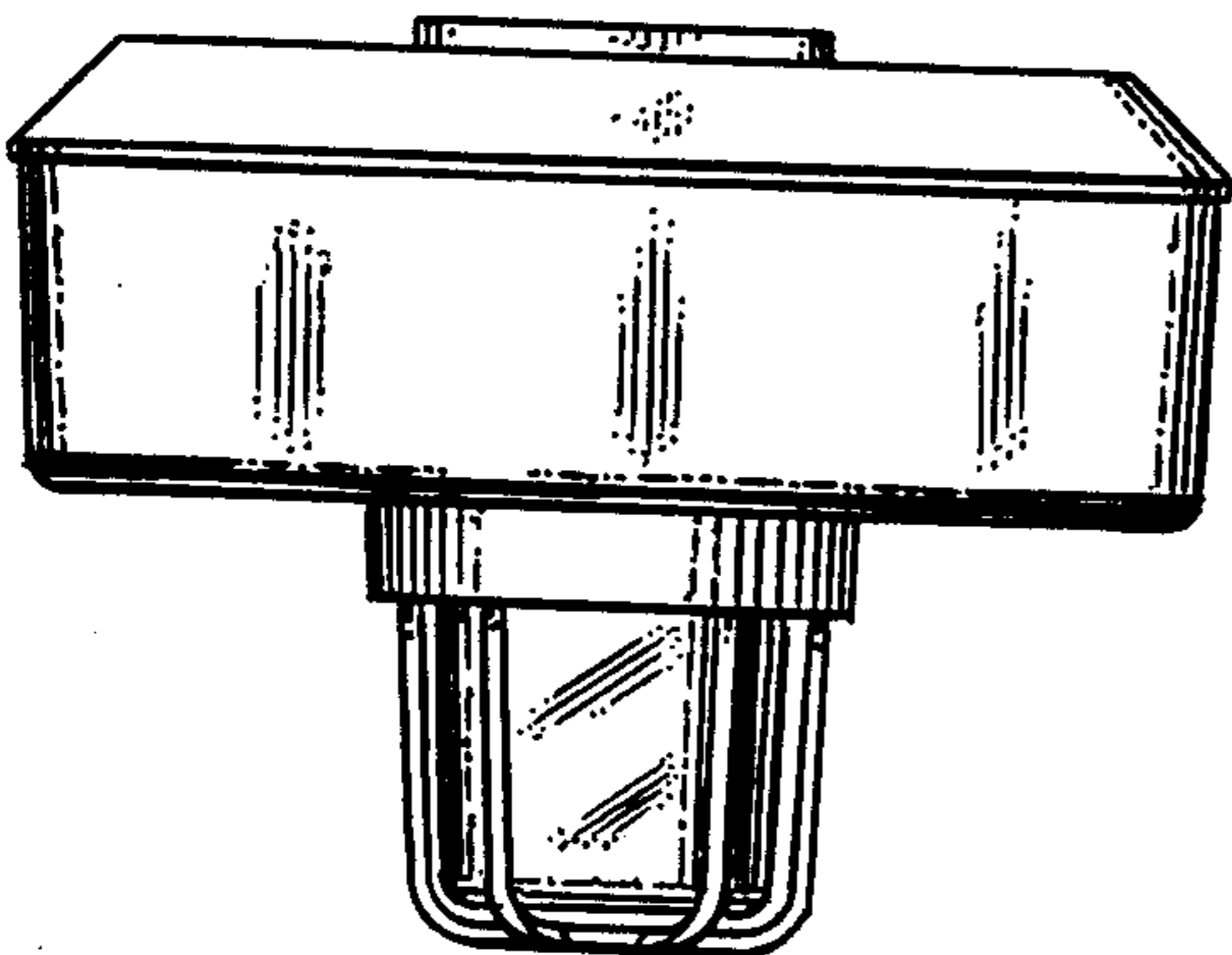




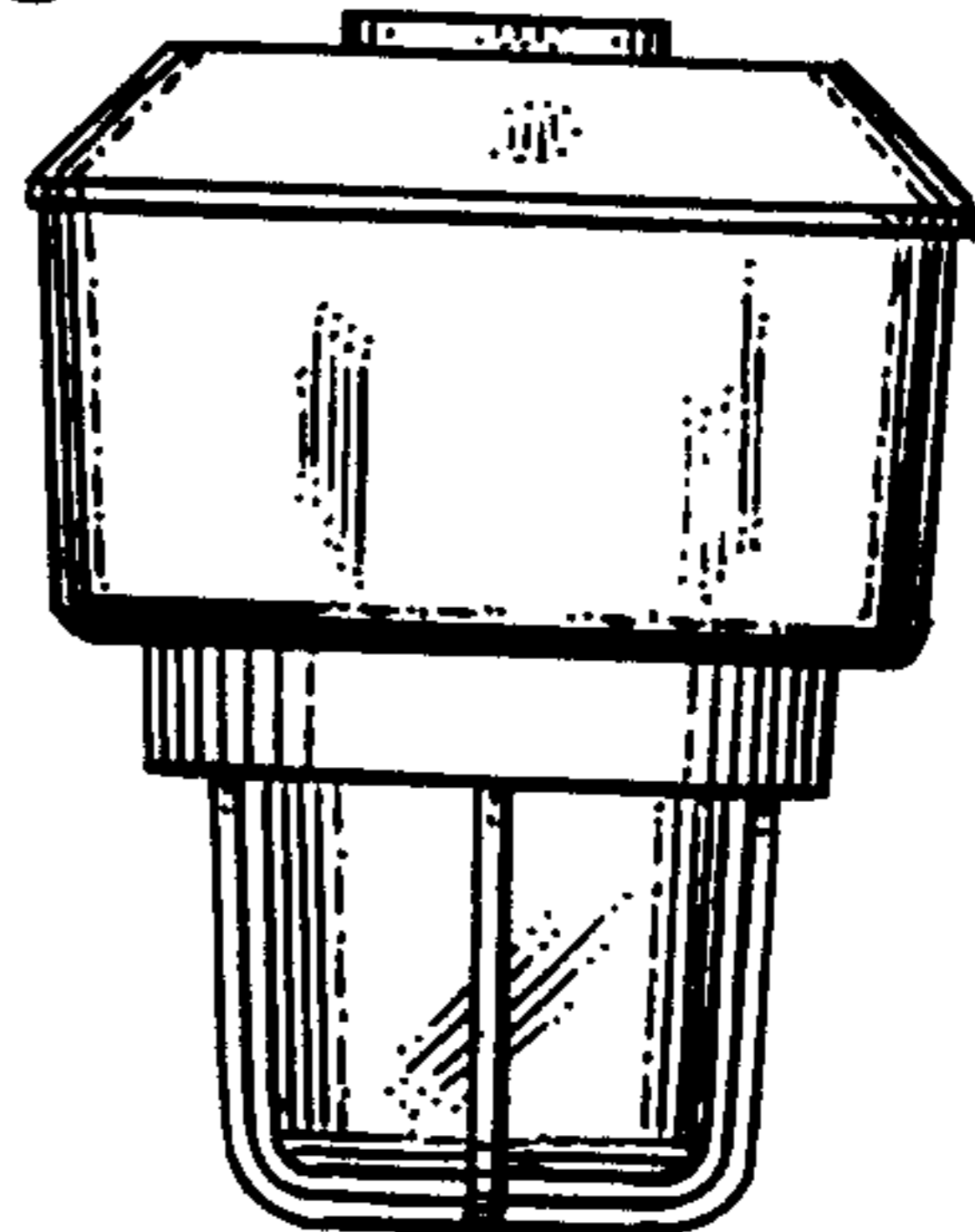
*Fig. 30.*



*Fig. 29.*



*Fig. 32.*



*Fig. 31.*

