

[54] PACKAGING CONTAINER

[75] Inventors: Morris Simon Freed, Newton Centre; George Walter Ward, Framingham, both of Mass.

[73] Assignee: Data General Corporation

[**] Term: 14 Years

[21] Appl. No.: 643,449

[22] Filed: Dec. 22, 1975

[51] Int. Cl. D9-03

[52] U.S. Cl. D9/184

[58] Field of Search 206/214-215; 229/30; D9/184-189, 230-240

[56] References Cited

U.S. PATENT DOCUMENTS

- D. 30,427 3/1899 Becton D9/184
- 1,787,498 6/1931 Tinsley D9/184 X

3,270,877 9/1966 Hecker D9/189 X

Primary Examiner—Robert C. Spangler
Attorney, Agent, or Firm—Jacob Frank

[57] CLAIM

The ornamental design for a packaging container, or similar article, as shown and described.

DESCRIPTION

FIG. 1 is a front perspective view of a packaging container showing my new design, in a partially opened position;
 FIG. 2 is a rear perspective view thereof;
 FIG. 3 is a perspective view with the packaging container in an open position;
 FIG. 4 is a top plan view thereof;
 FIG. 5 is a top perspective view with the packaging container in a closed position; and
 FIG. 6 is an interior perspective view with the packaging container in an open position.

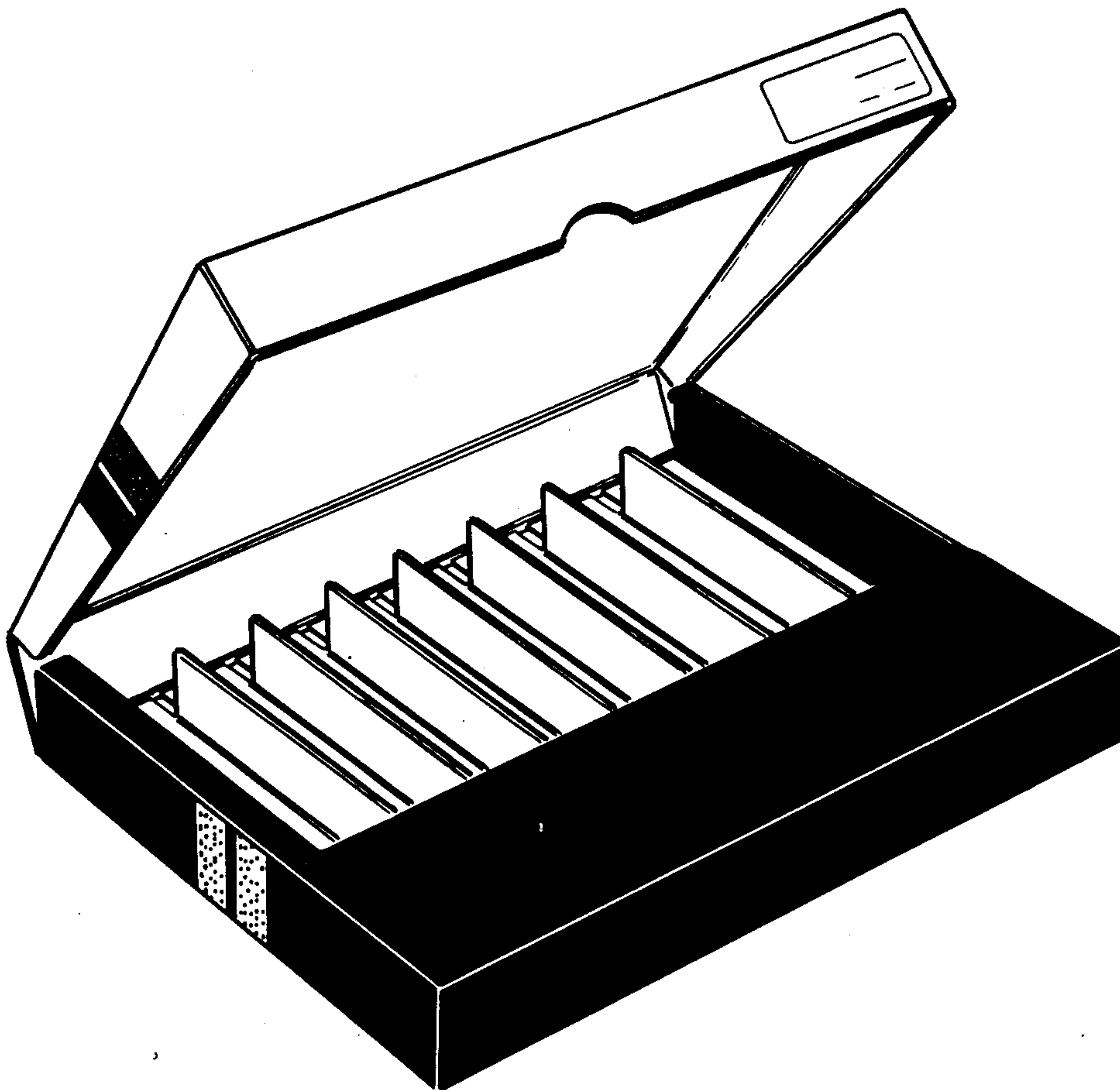

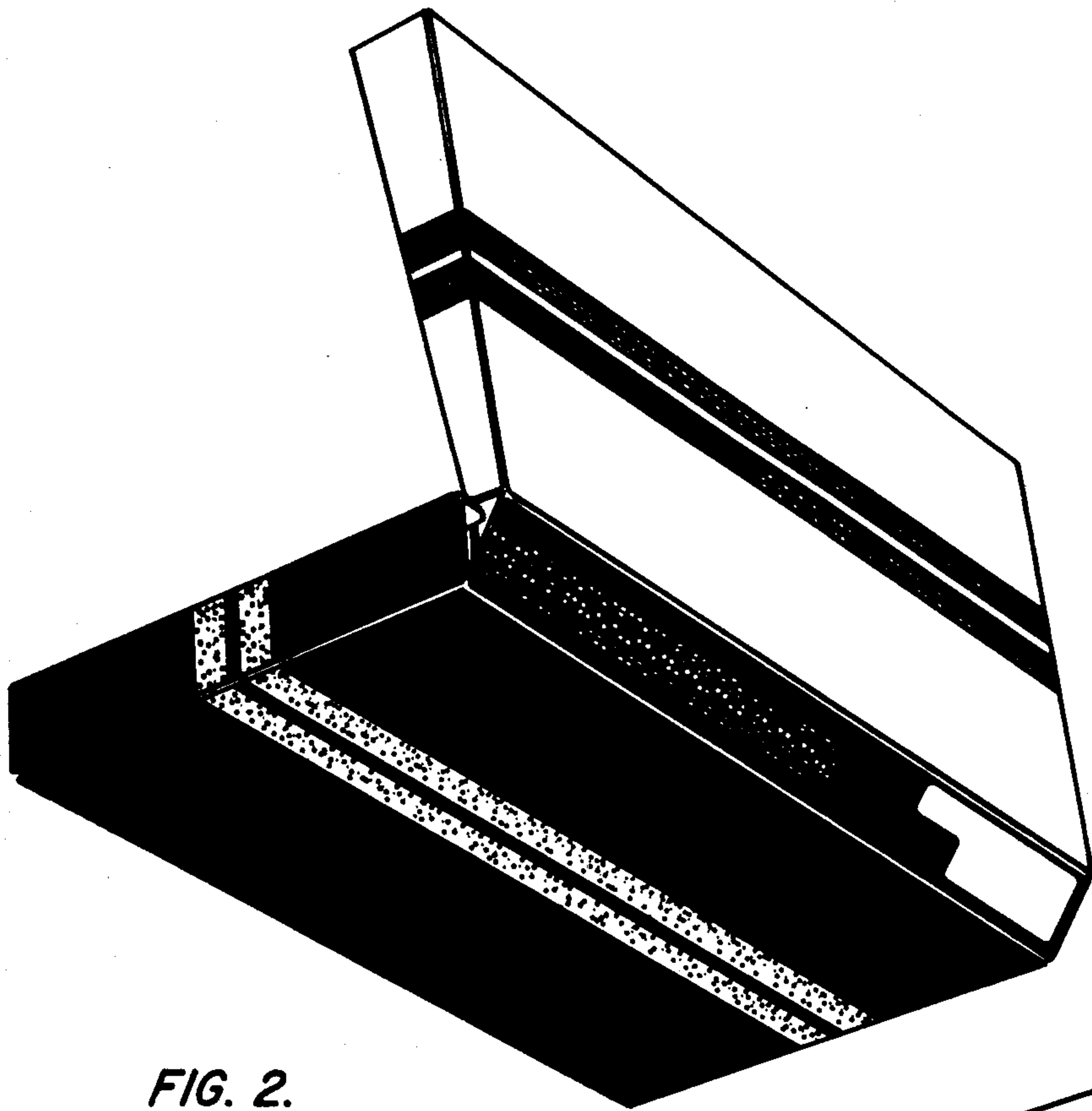

FIG. 2.

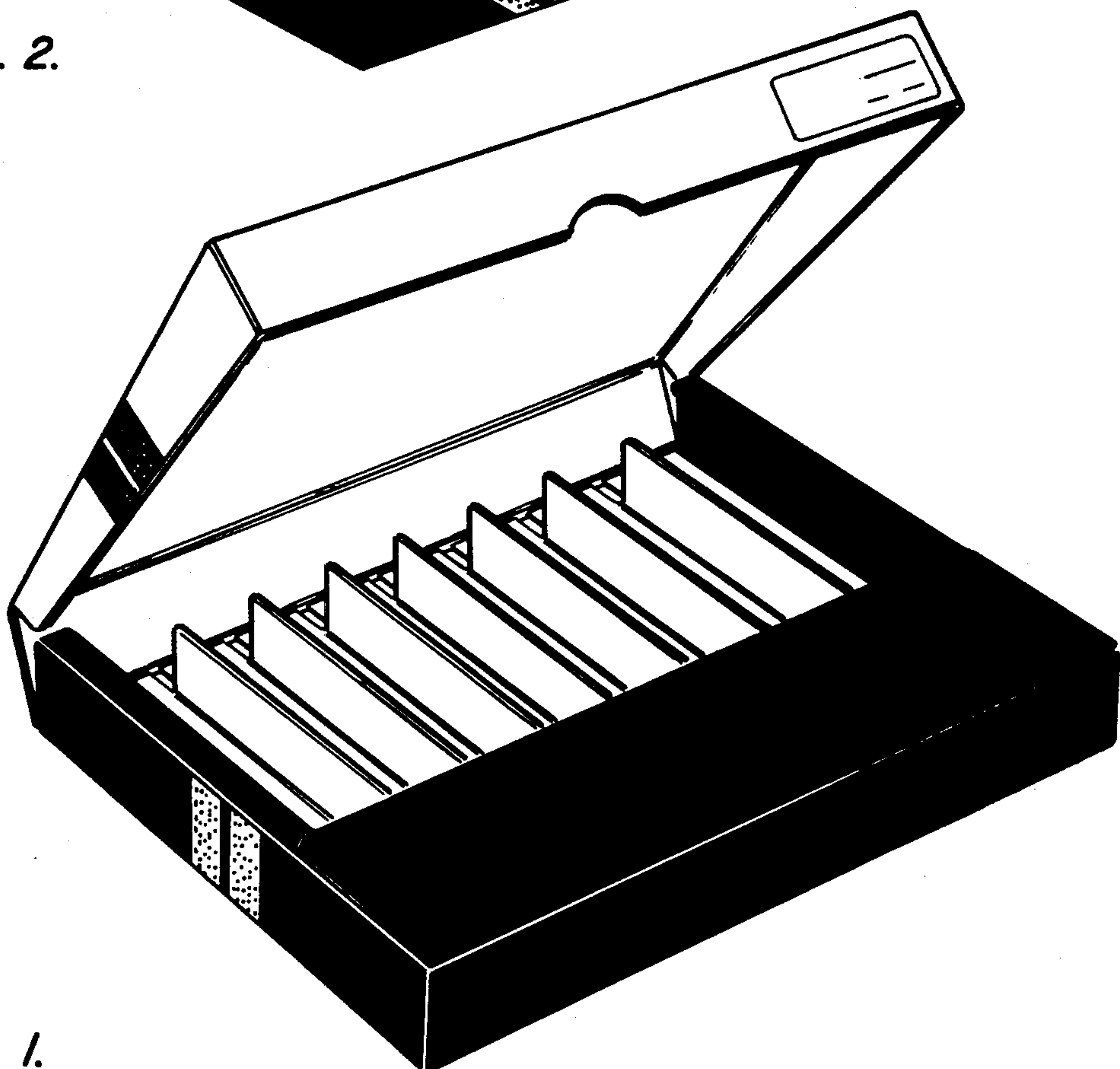

FIG. 1.

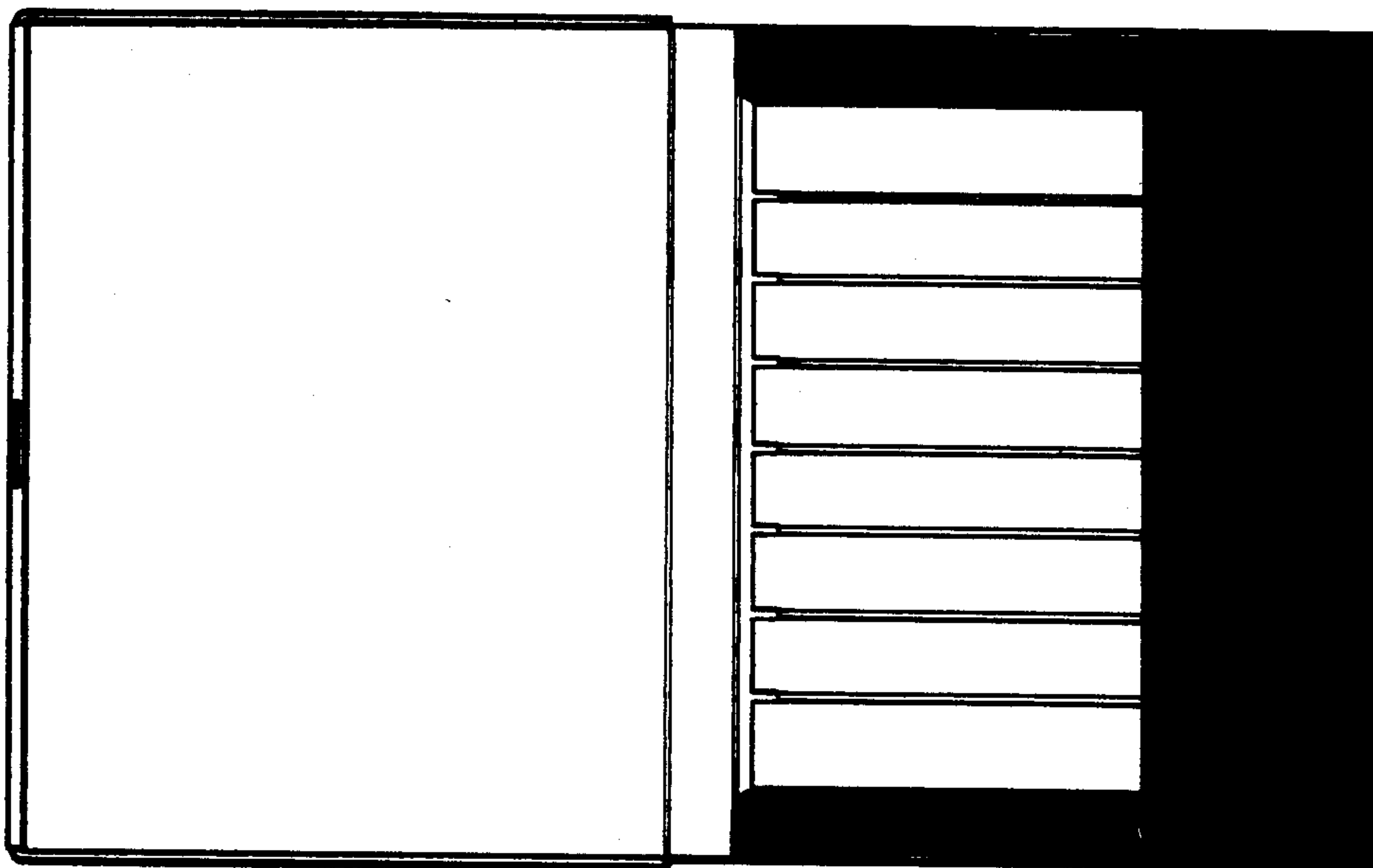

FIG. 4.

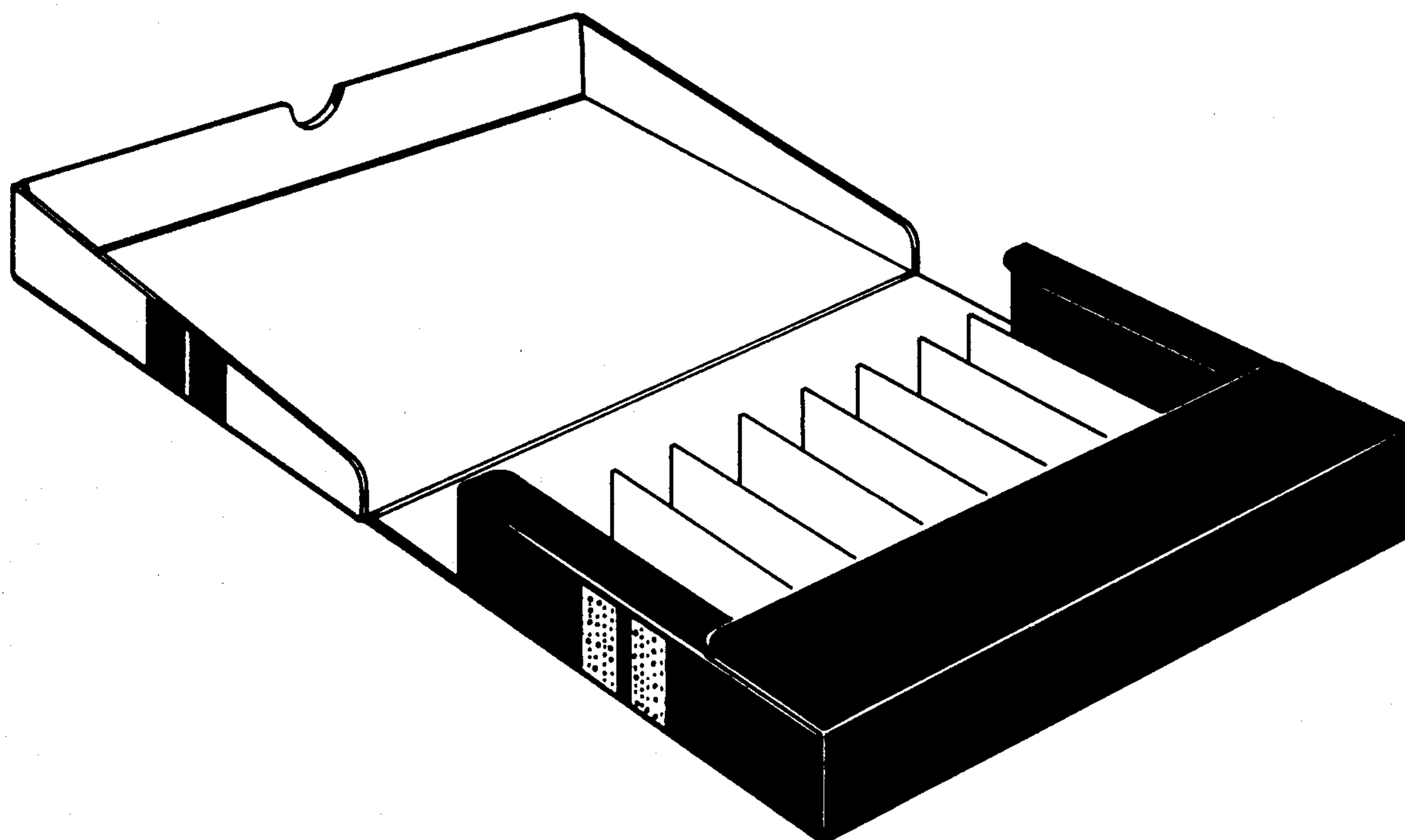

FIG. 3.

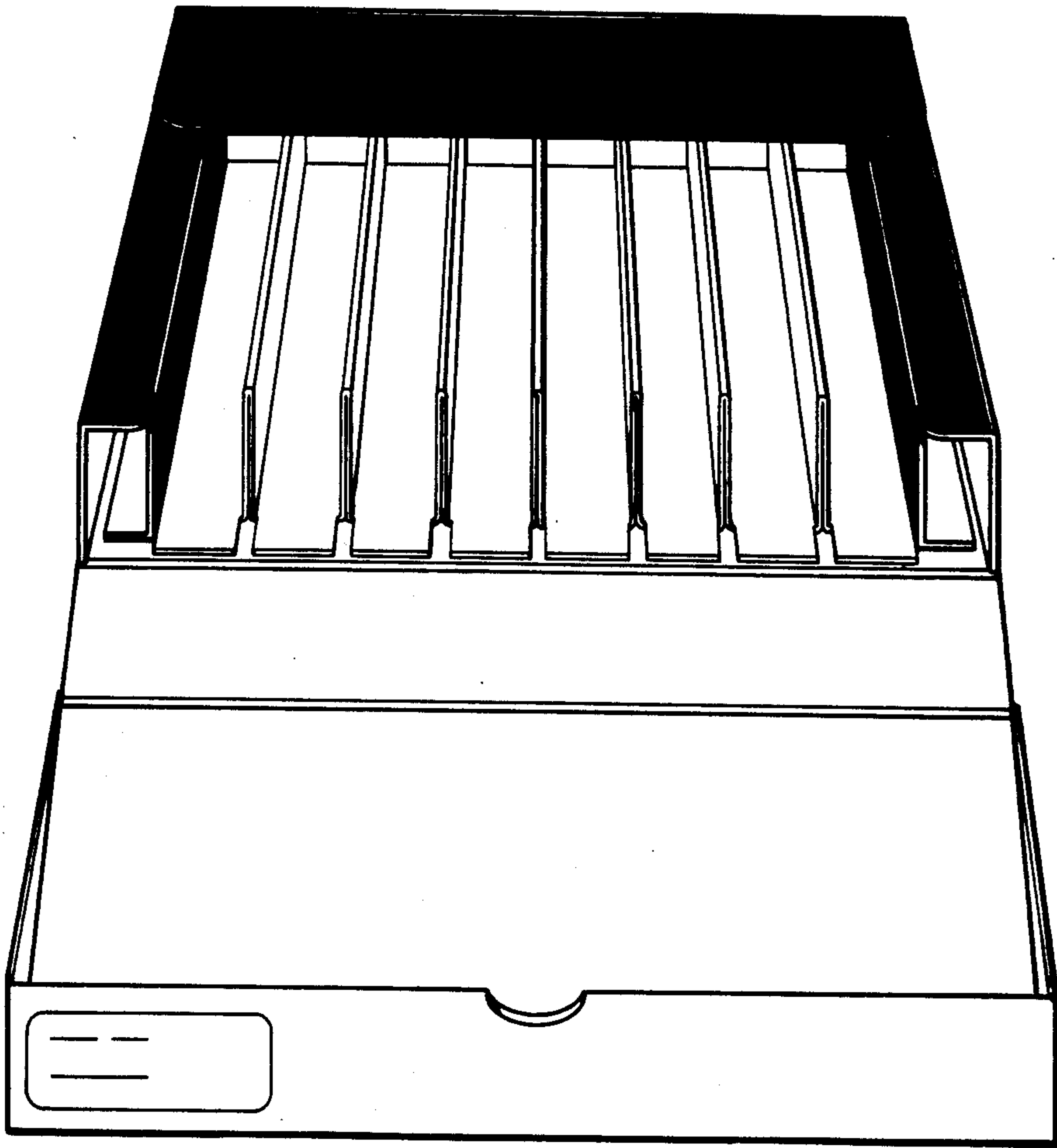

FIG. 6.

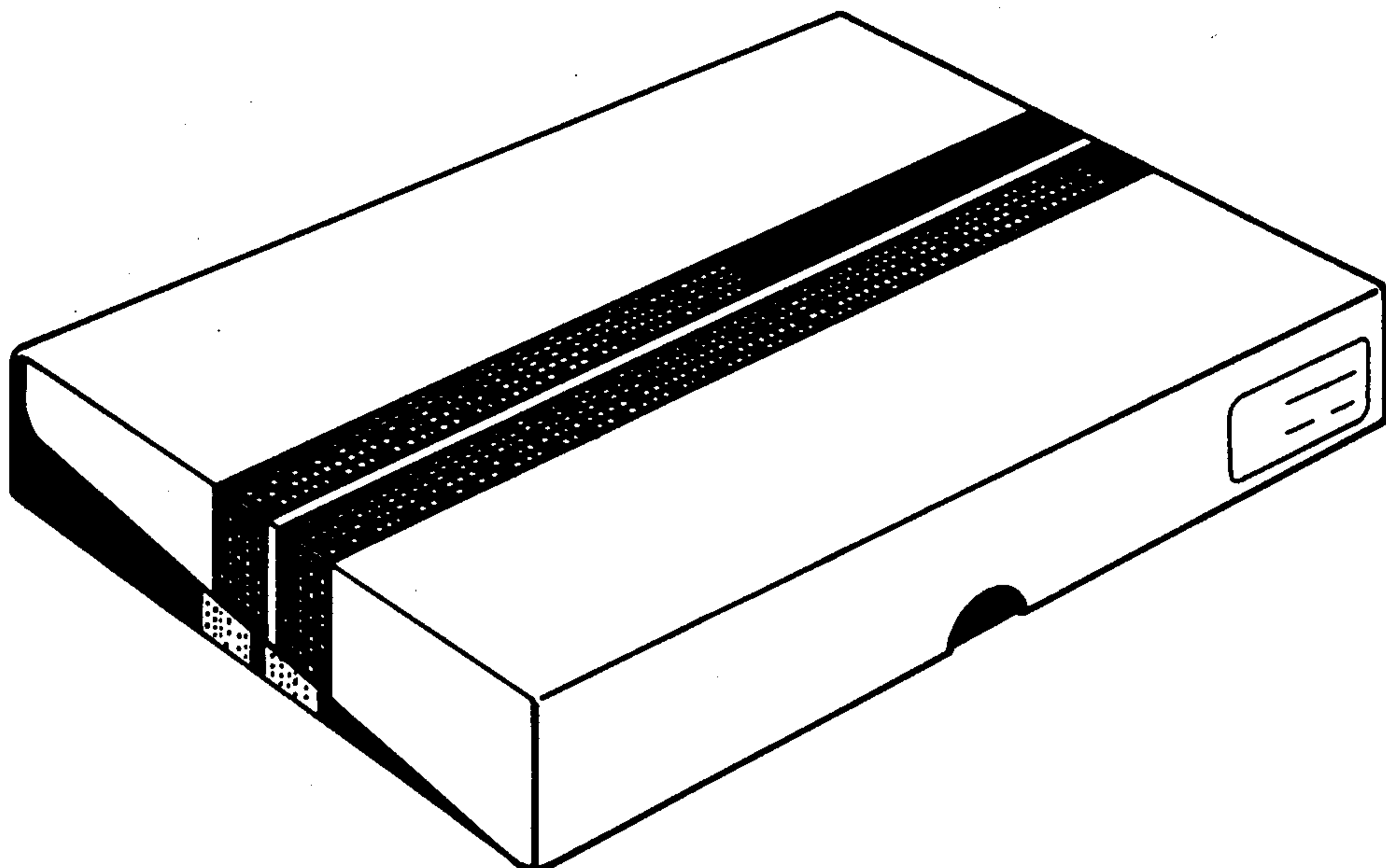

FIG. 5.