

[54] PANIC OPERATOR FOR EXIT DOORS

[75] Inventors: Roger J. Folger, Whittier; John A. Buzard, Yorba Linda, both of Calif.

[73] Assignee: Adams Rite Manufacturing Co., Glendale, Calif.

[**] Term: 14 Years

[21] Appl. No.: 688,489

[22] Filed: May 19, 1976

[51] Int. Cl. D8-07

[52] U.S. Cl. D8/302; D8/319

[58] Field of Search D8/302, 316, 319; 16/DIG. 5, 9; 292/92

[56] References Cited

U.S. PATENT DOCUMENTS

D. 49,410	7/1916	Sargent	D8/316
D. 118,619	1/1940	Erickson	D8/316
3,663,047	5/1972	Zawadzki	292/92

FOREIGN PATENT DOCUMENTS

2,444,628 4/1975 Fed. Rep. of Germany 292/92

Primary Examiner—Susan J. Lucas

Assistant Examiner—B. J. Bullock

Attorney, Agent, or Firm—R. Welton Whann

[57] CLAIM

The ornamental design for a panic operator for exit doors, as shown.

DESCRIPTION

FIG. 1 is a front perspective view showing our new design for a panic operator for exit doors, and which has a planar non-ornamented rear face (not shown); FIG. 2 is a front elevational view thereof; FIG. 3 is a bottom plan view thereof; FIG. 4 is an elevational view of the left end as seen in FIG. 2; FIG. 5 is an elevational view of the right end as seen in FIG. 2; and FIG. 6 is a transverse sectional view, taken substantially on line 6—6 of FIG. 1.

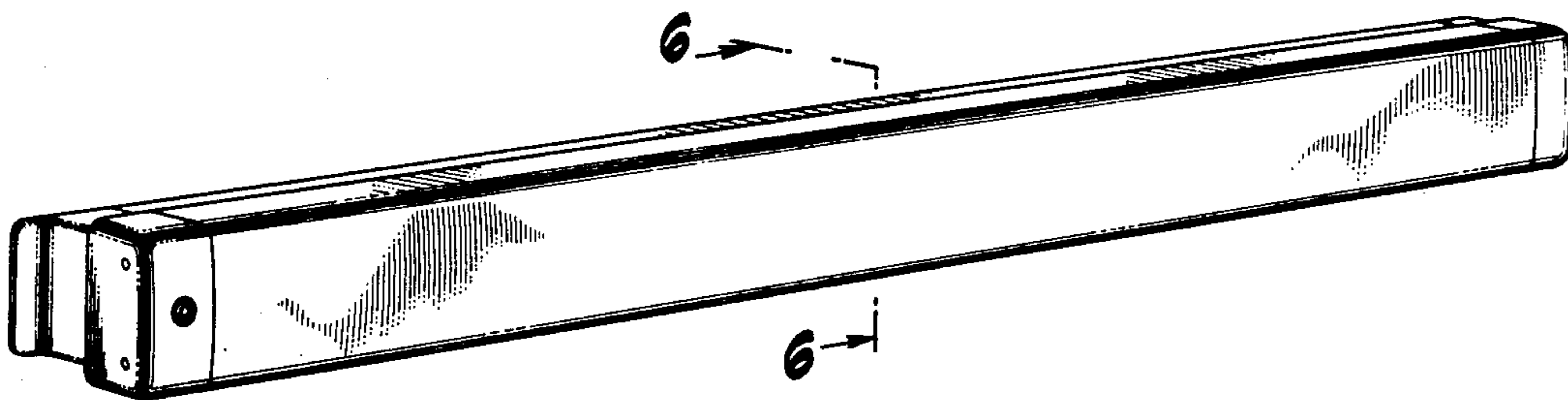

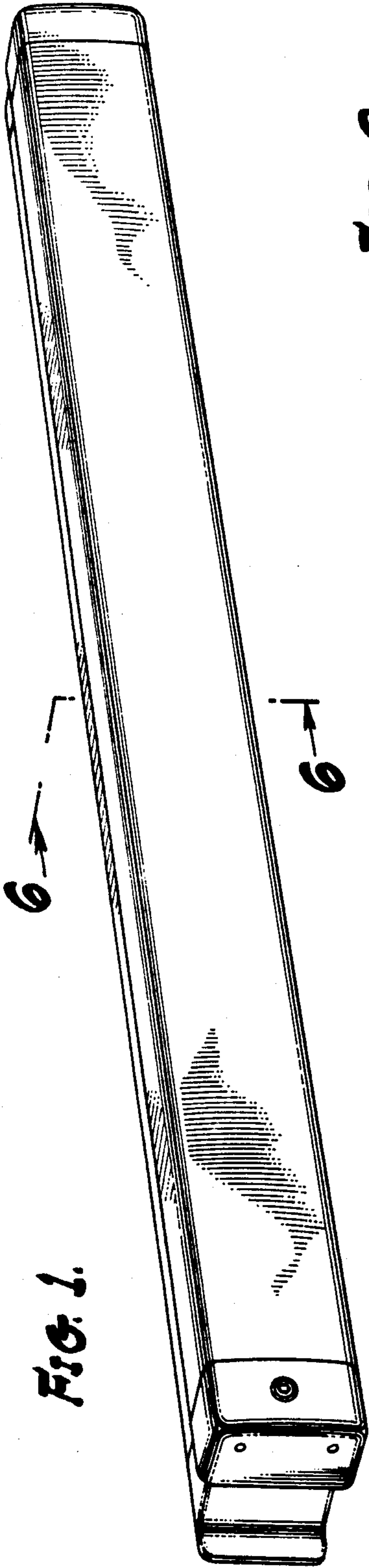

FIG. 2.

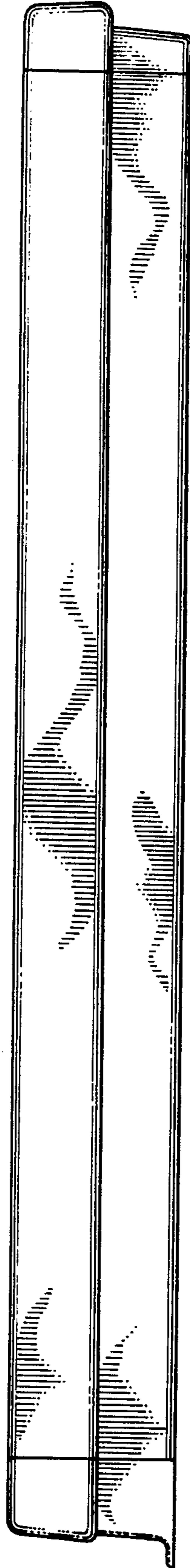
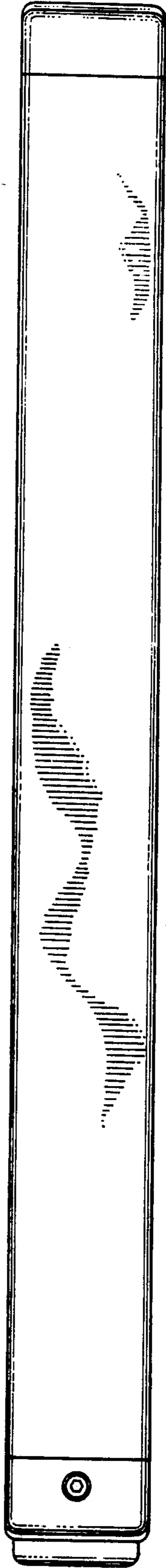

FIG. 3.

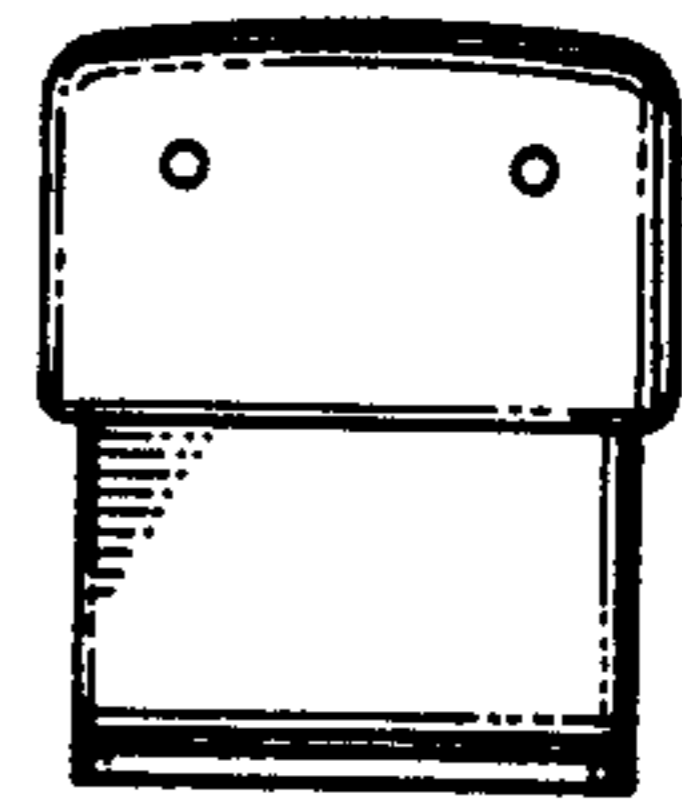

FIG. 4.

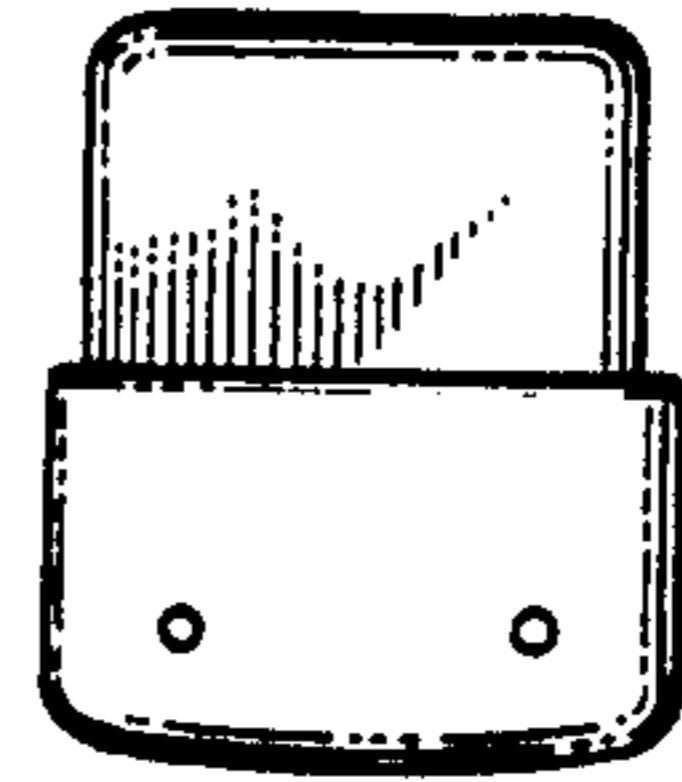

FIG. 5.

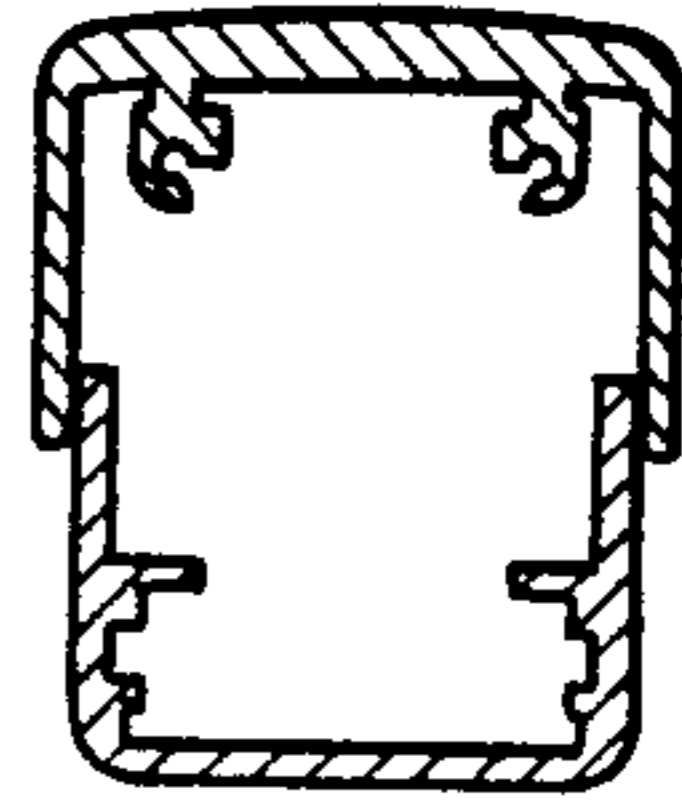

FIG. 6.