

[54] CAMERA
 [75] Inventor: Rene C. Pinchuk, Kensington, Calif.
 [73] Assignee: Ehrenreich Photo-Optical Industries Inc., San Francisco, Calif.
 [**] Term: 14 Years
 [21] Appl. No.: 703,023
 [22] Filed: Jul. 6, 1976
 [51] Int. Cl. D16-01
 [52] U.S. Cl. D16/06
 [58] Field of Search D16/1-10, D16/38; 354/152-158, 162, 170-173, 174, 202, 288

D. 230,514 2/1974 Emmerling D16/9
 D. 236,546 8/1975 Shimano et al. D16/9
 D. 241,167 8/1976 Woodring et al. D16/6

Primary Examiner—Wallace R. Burke
 Assistant Examiner—Catherine Kemper
 Attorney, Agent, or Firm—Stephen S. Townsend

[57] CLAIM

The ornamental design for a camera, as shown.

DESCRIPTION

FIG. 1 is a perspective view of a camera showing my new design;
 FIG. 2 is a top plan view thereof;
 FIG. 3 is a front view thereof;
 FIG. 4 is a right side view thereof;
 FIG. 5 is a bottom plan view thereof;
 FIG. 6 is a back view thereof;
 FIG. 7 is a left side view thereof; and
 FIG. 8 is a bottom rear perspective view thereof.

[56] References Cited
 U.S. PATENT DOCUMENTS
 D. 228,681 10/1973 Swayze D16/6

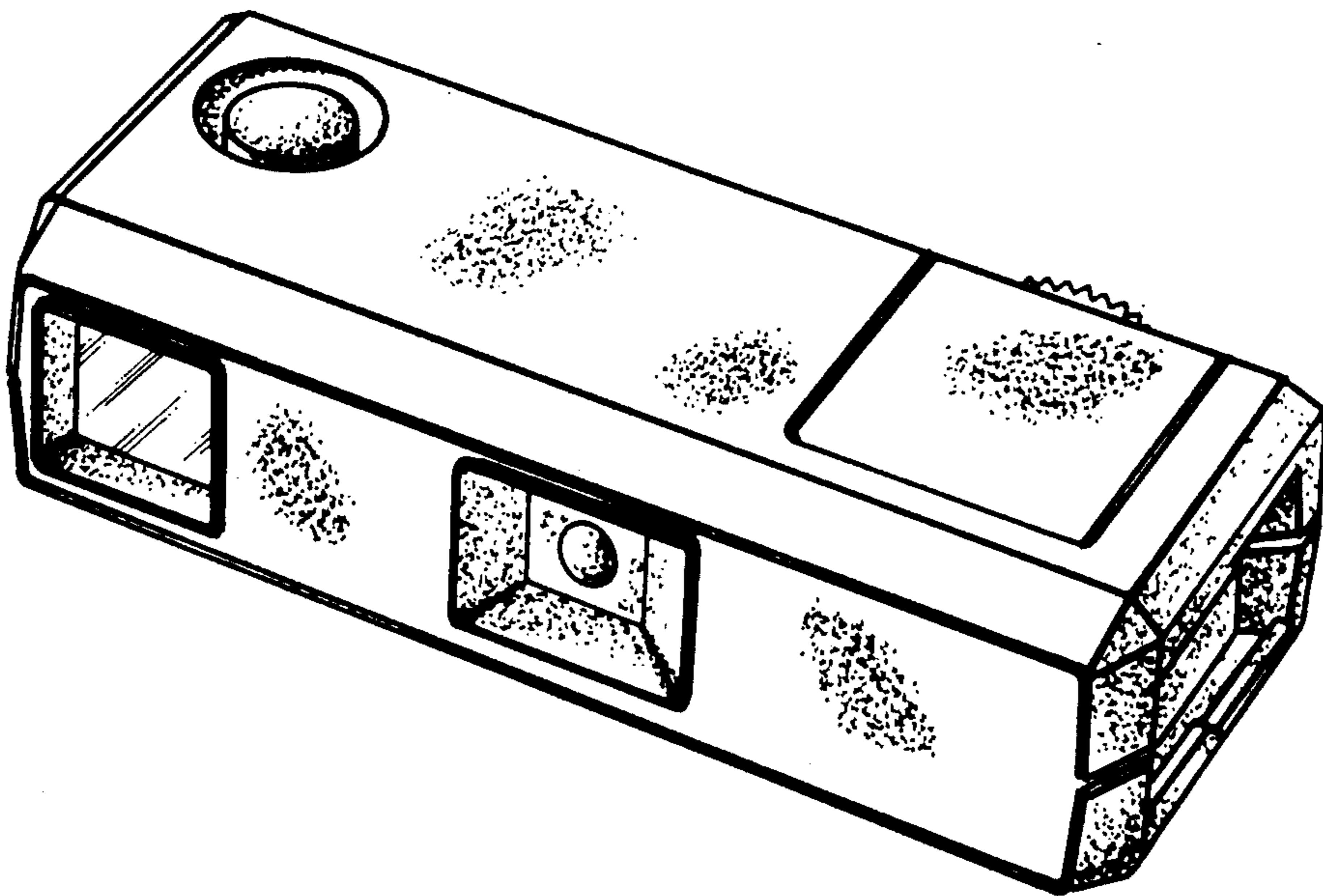

FIG _ 1

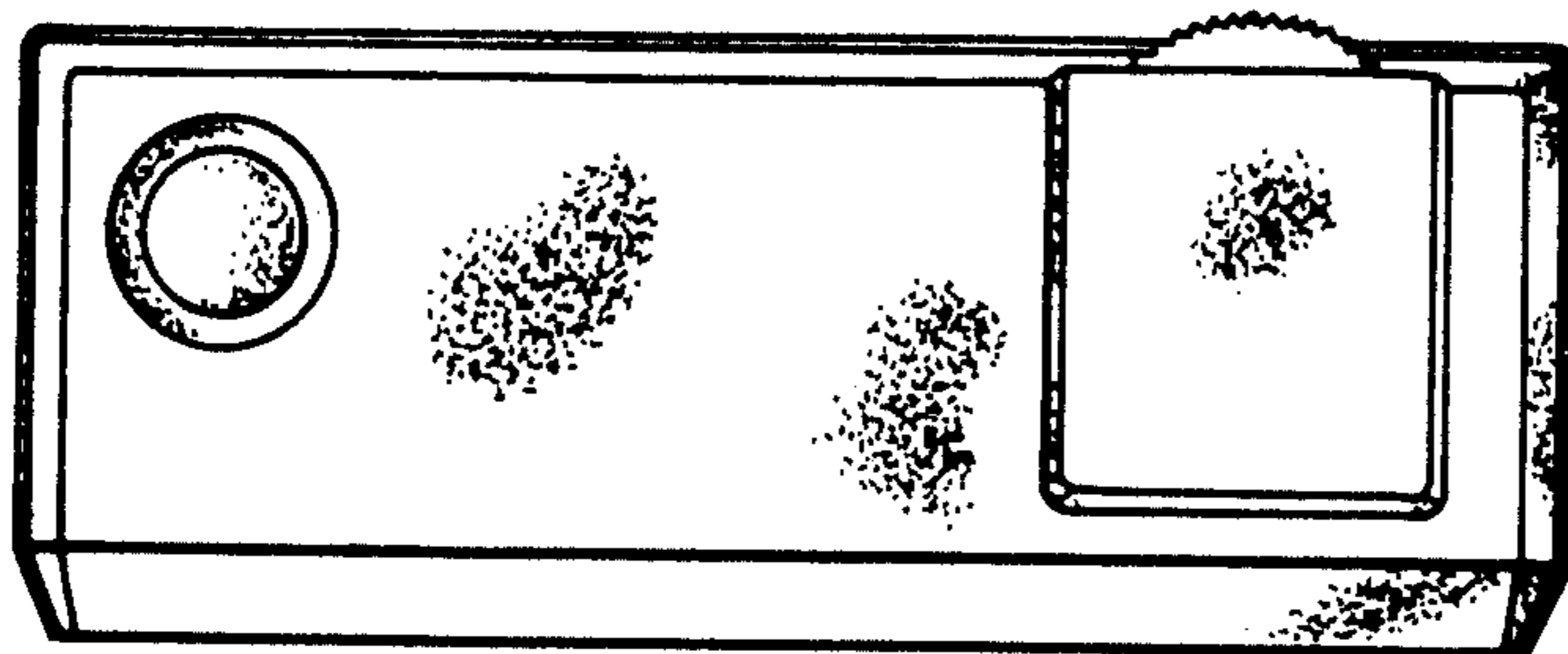
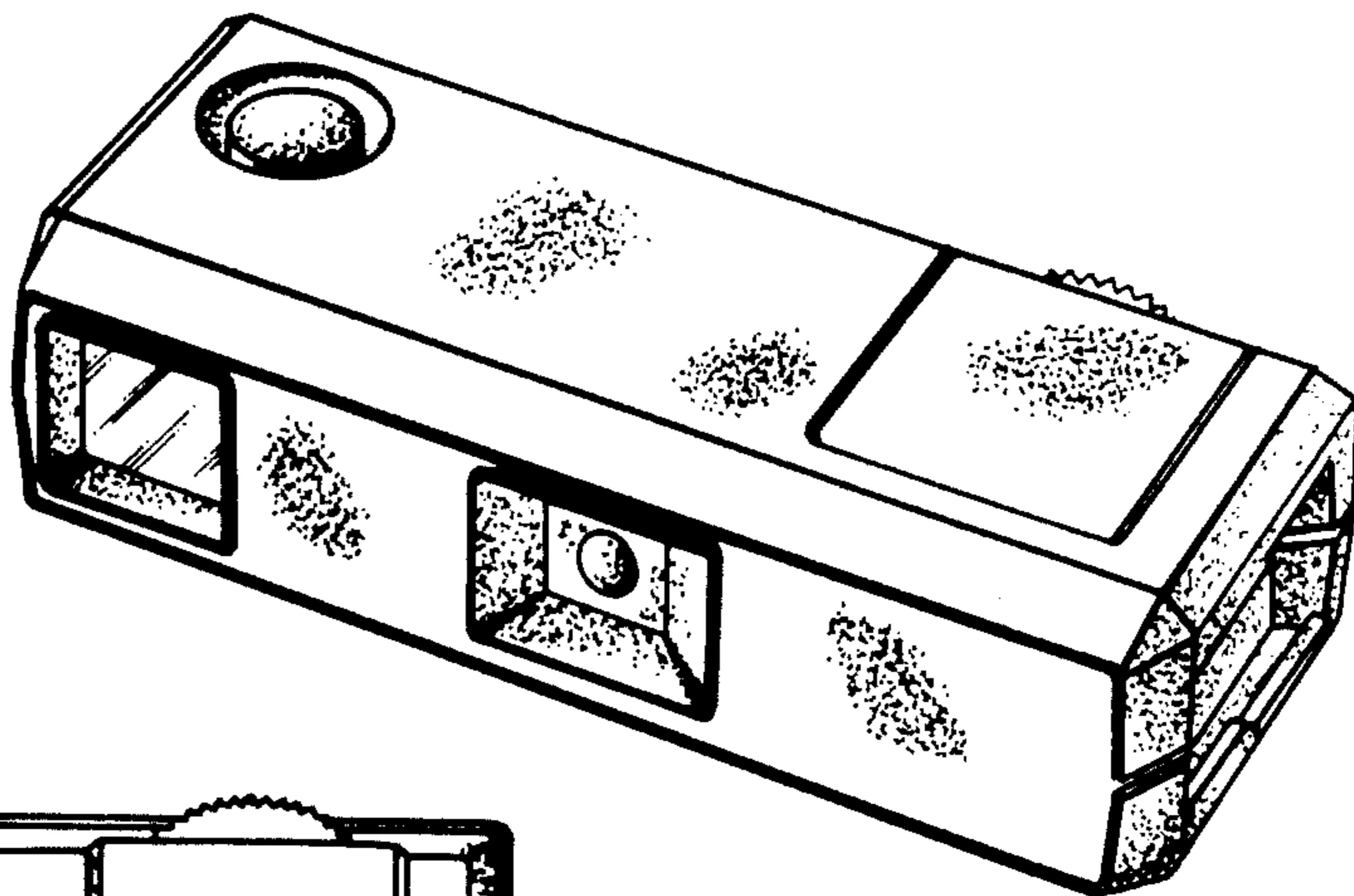

FIG _ 2

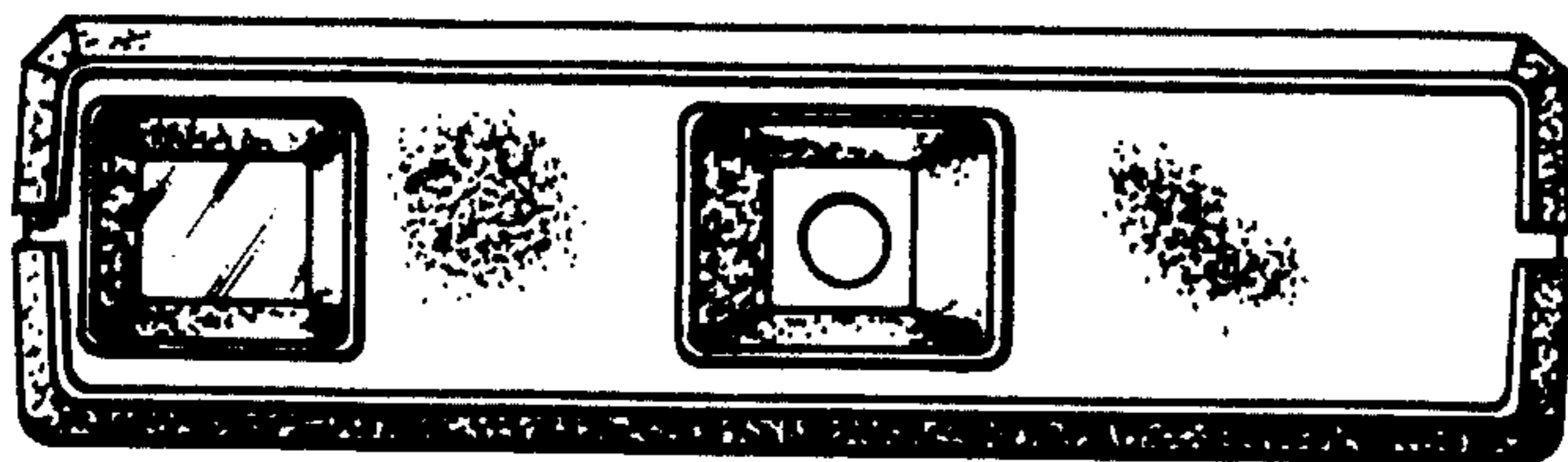

FIG _ 3

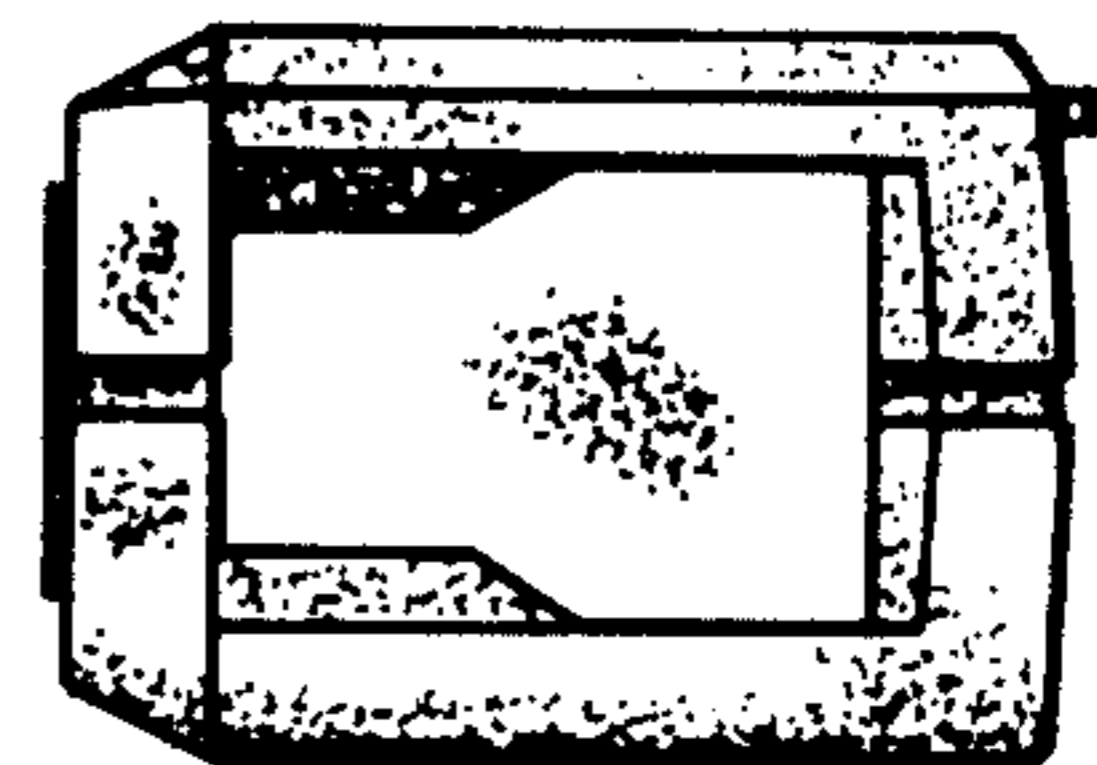

FIG _ 4

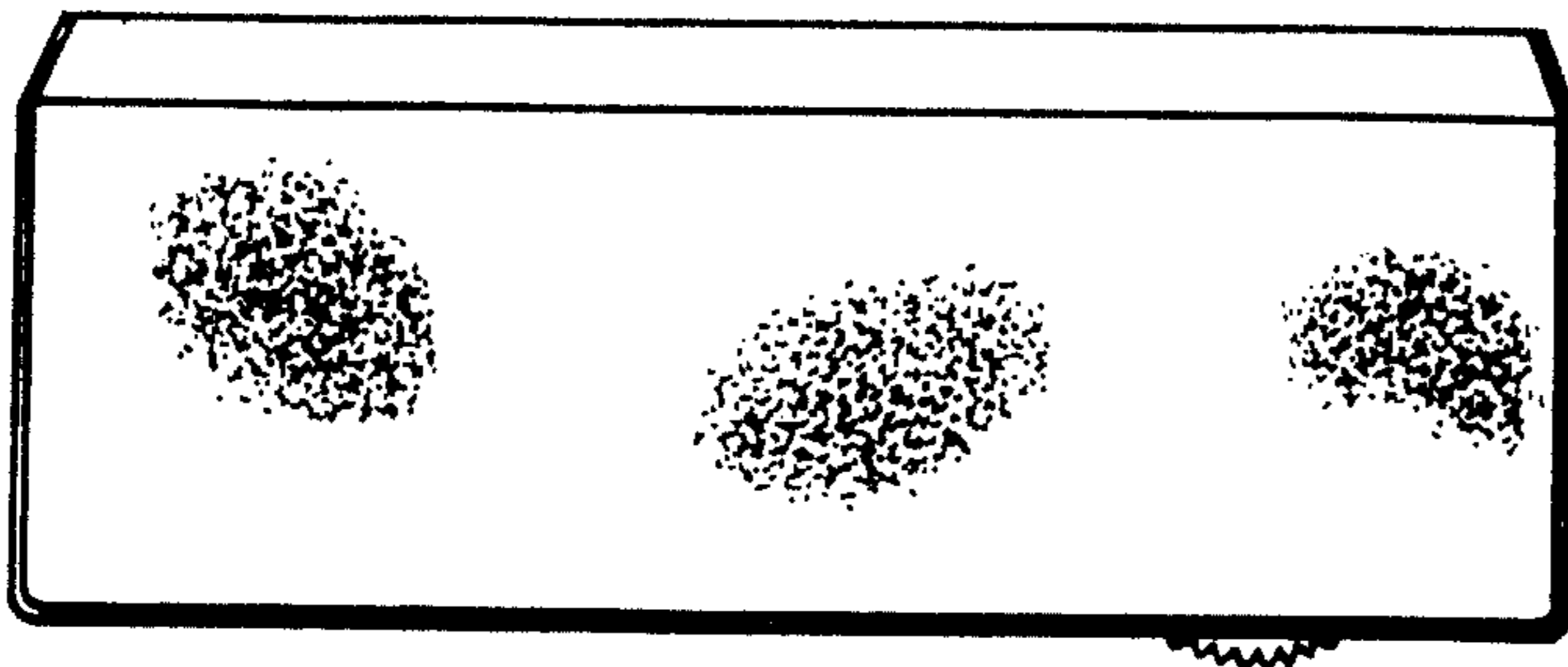

FIG _ 5

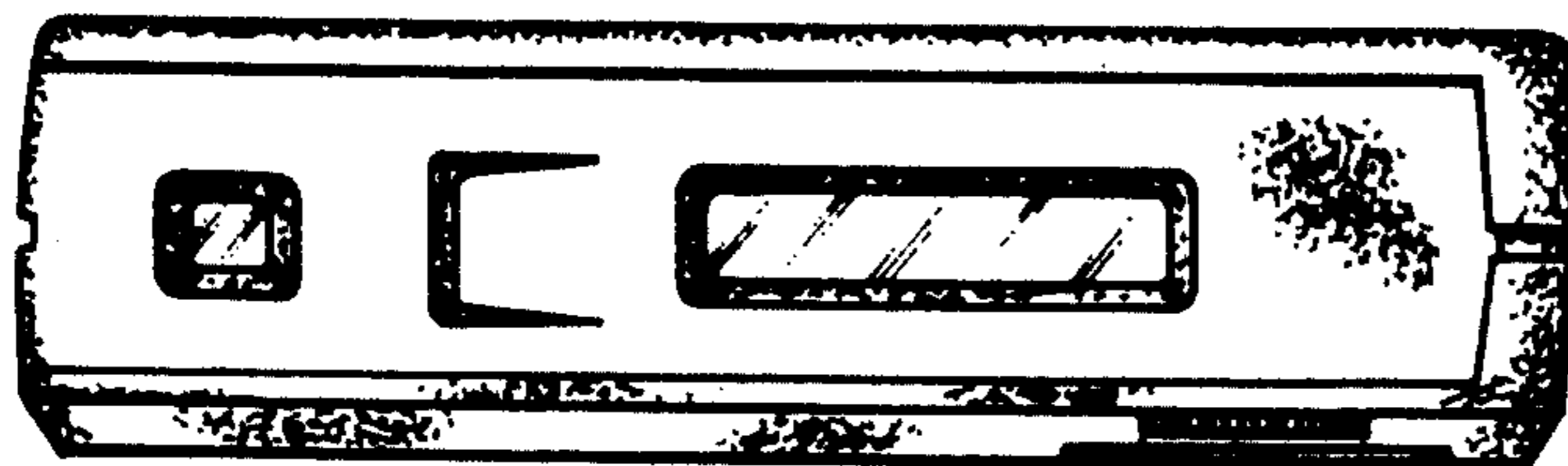

FIG _ 6

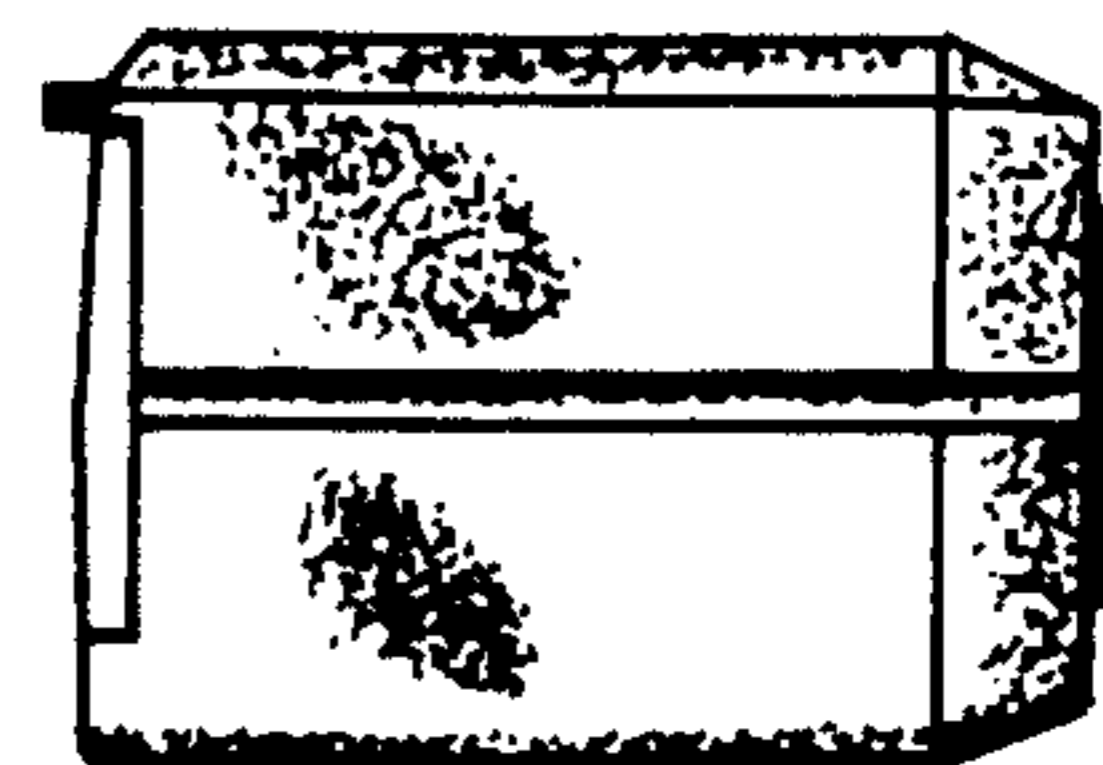

FIG _ 7

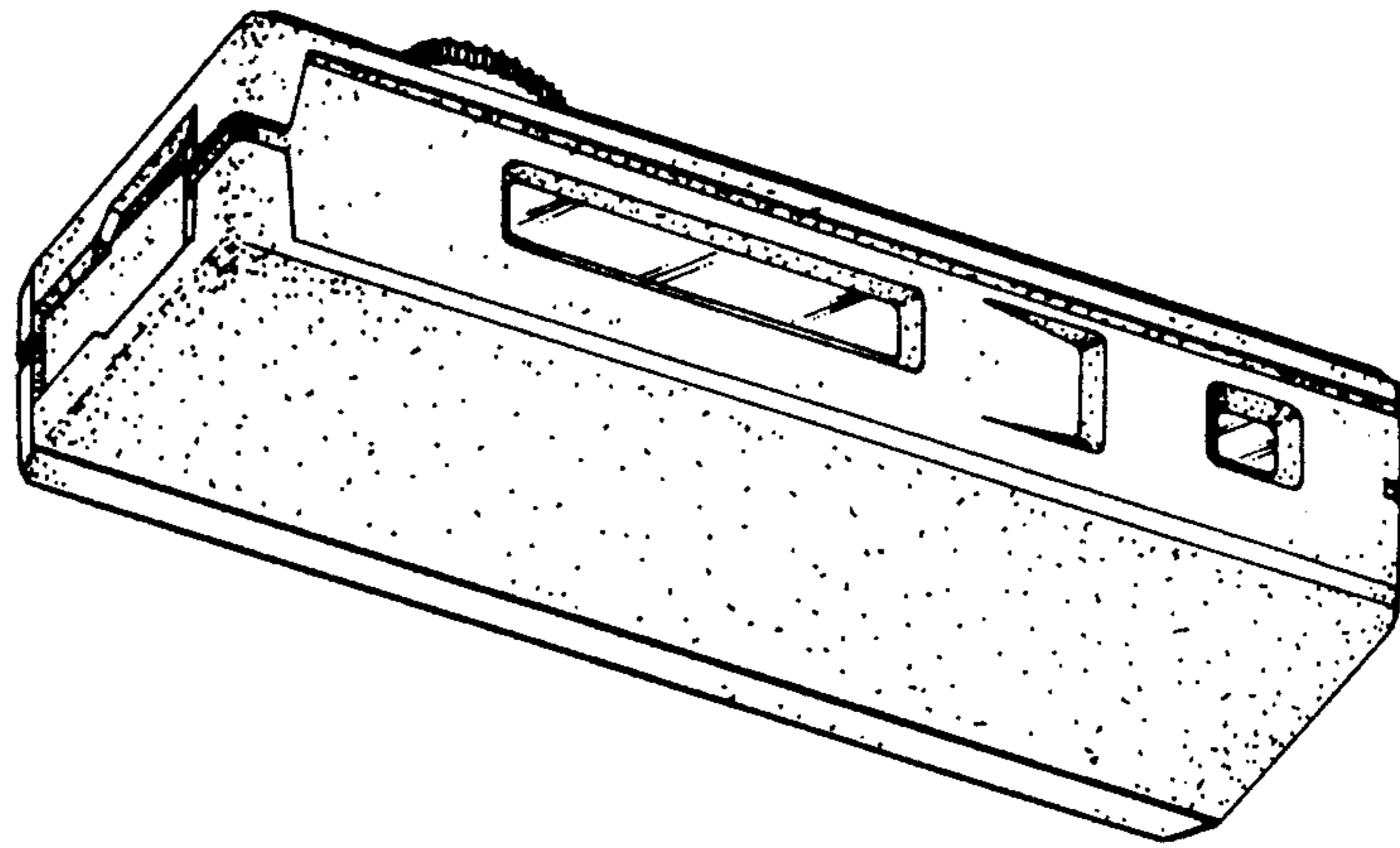

FIG. — 8