

[54] MONEY BELT

[75] Inventor: John A. Renick, Tampa, Fla.

[73] Assignee: John Renick Enterprises, Inc., Tampa, Fla.

[**] Term: 14 Years

[21] Appl. No.: 713,614

[22] Filed: Aug. 9, 1976

[51] Int. Cl. D2-07

[52] U.S. Cl. D2/380

[58] Field of Search D2/380, 388, 393, 394, D2/405, 408, 414, 418, 442; 2/311, 321, 322; 24/204, 230 TC, 201 A

[56] References Cited

U.S. PATENT DOCUMENTS

D. 168,243 11/1952 Stelzer D2/414
2,090,789 8/1937 Forstner 24/225 X

OTHER PUBLICATIONS

House Beautiful, 11/52, p. 161, cinch belt at top left.
Harper's Bazaar, 11/52, p. 98, cinch belt at top.

Primary Examiner—Nelson C. Holtje
Attorney, Agent, or Firm—Thomas B. Van Poole

[57] CLAIM

The ornamental design for a money belt, as shown and described.

DESCRIPTION

FIG. 1 is a front perspective view of a money belt showing my new design with the buckle in the open condition;

FIG. 2 is a front perspective view thereof with the buckle in a closed condition;

FIG. 3 is a rear perspective view of FIG. 1;

FIG. 4 is a front elevational view of FIG. 2;

FIG. 5 is a top plan view of FIG. 2;

FIG. 6 is a fragmentary rear perspective view of FIG. 4;

FIG. 7 is a fragmentary front perspective view of another embodiment of my new design of FIG. 1 wherein a different male buckle portion is shown, all other views being the same as FIGS. 1-6.

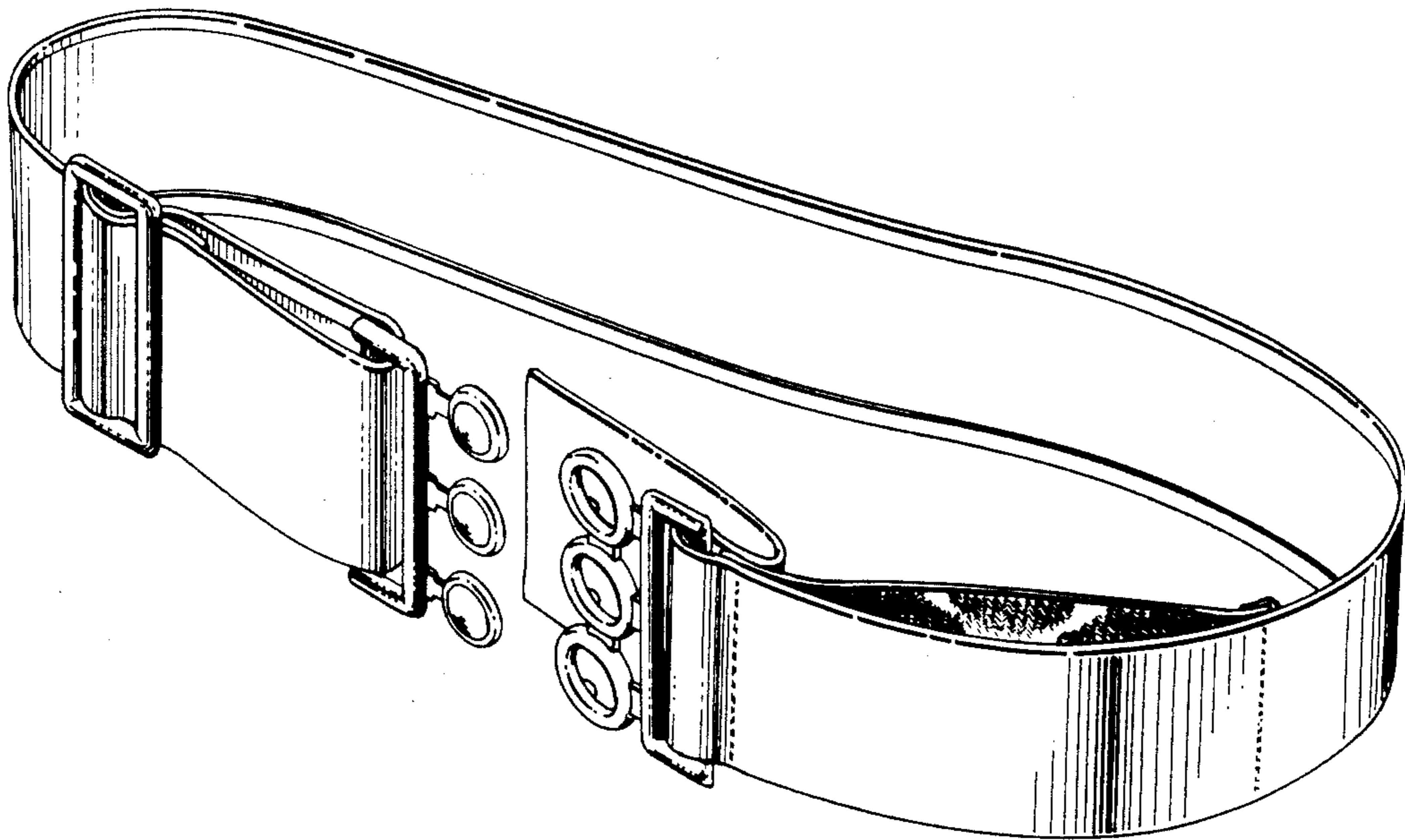

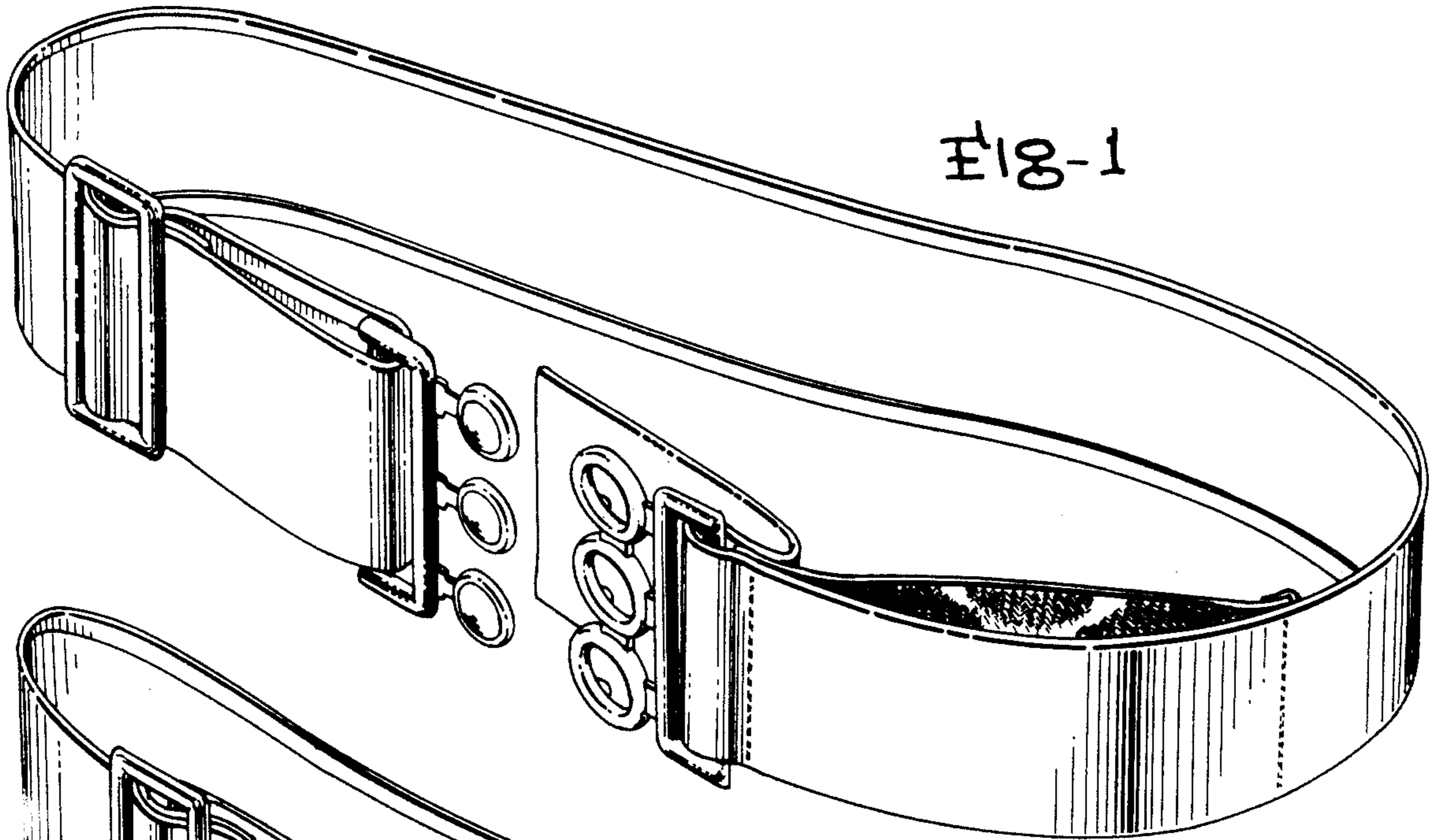

Fig-1

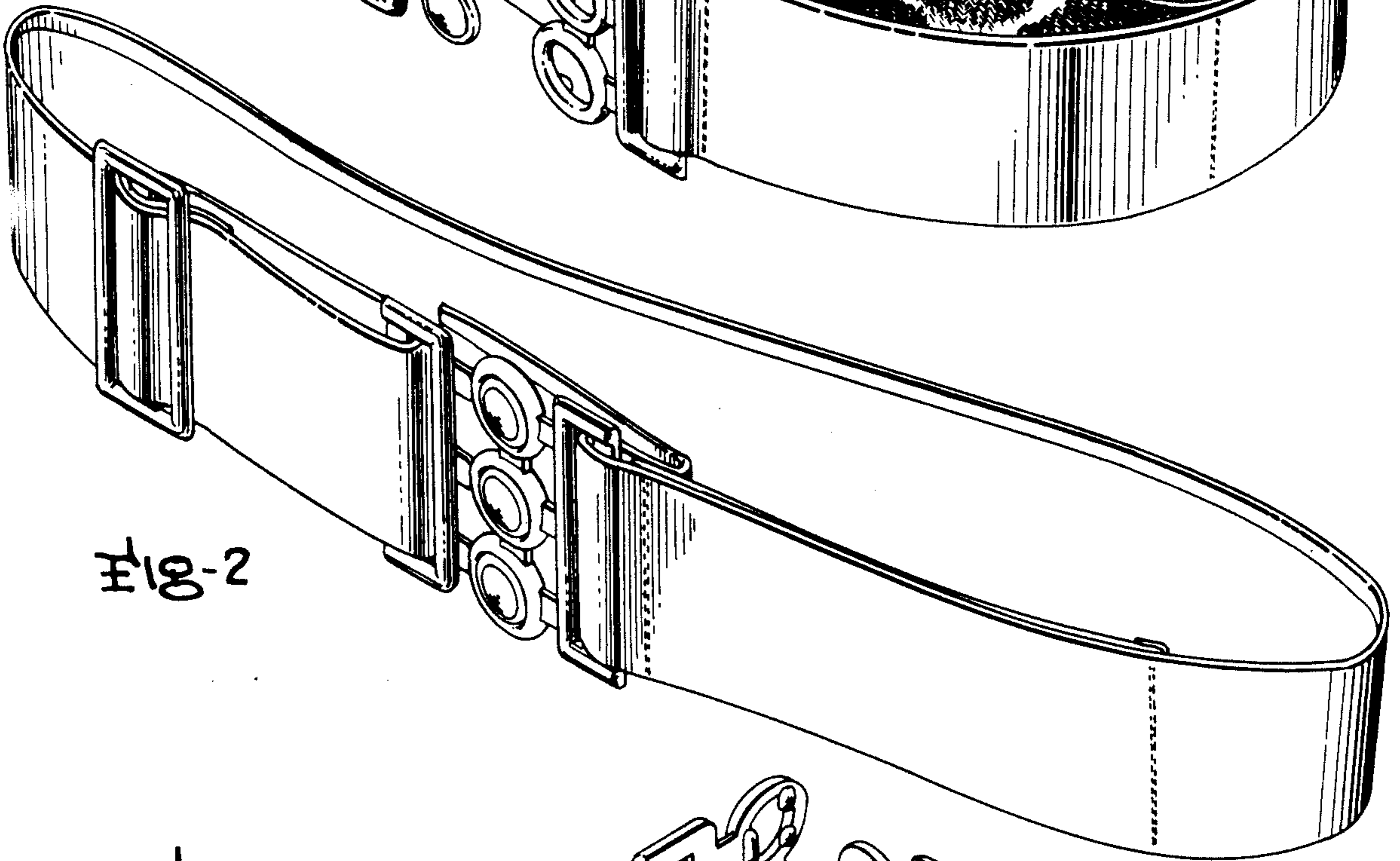

Fig-2

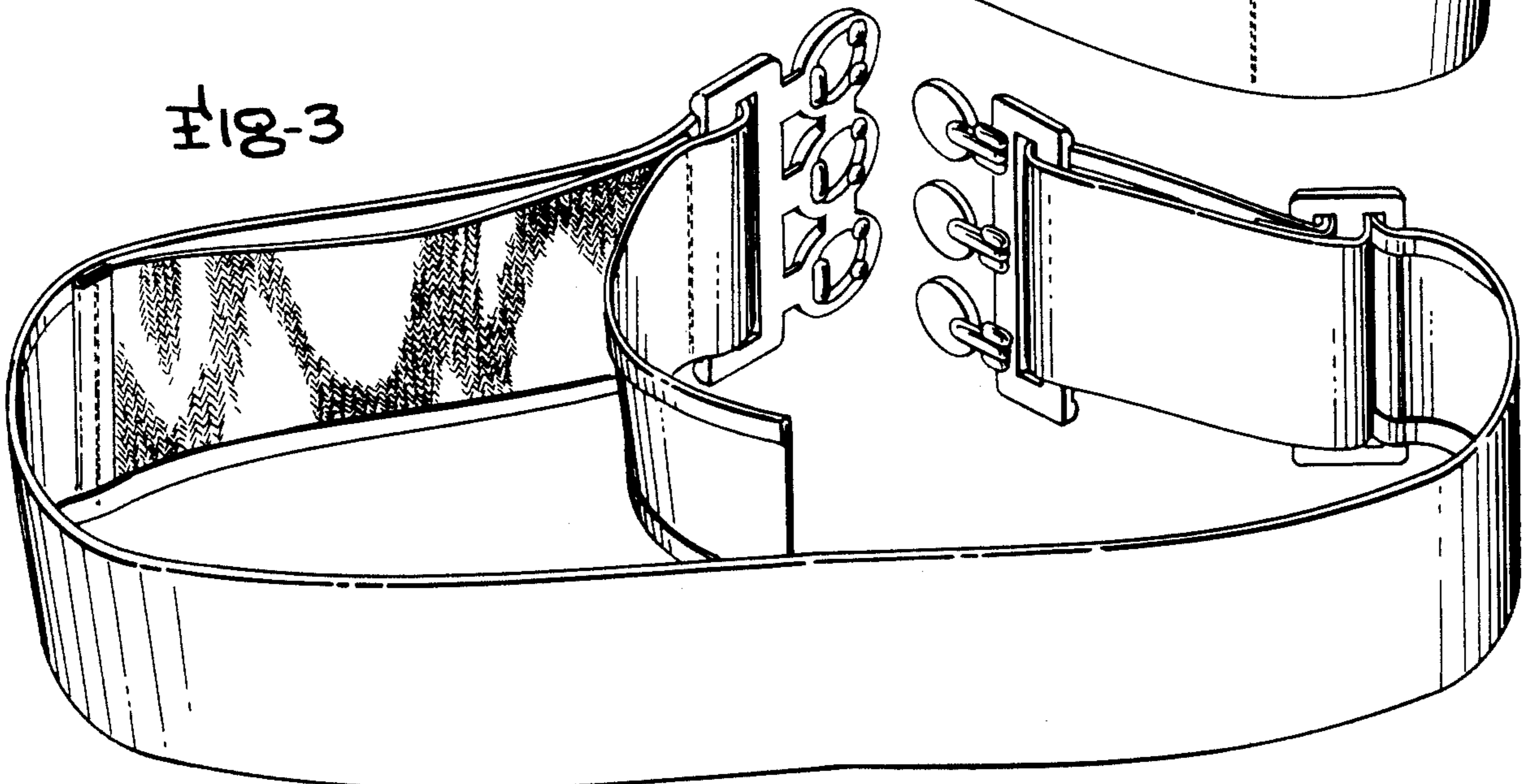

Fig-3

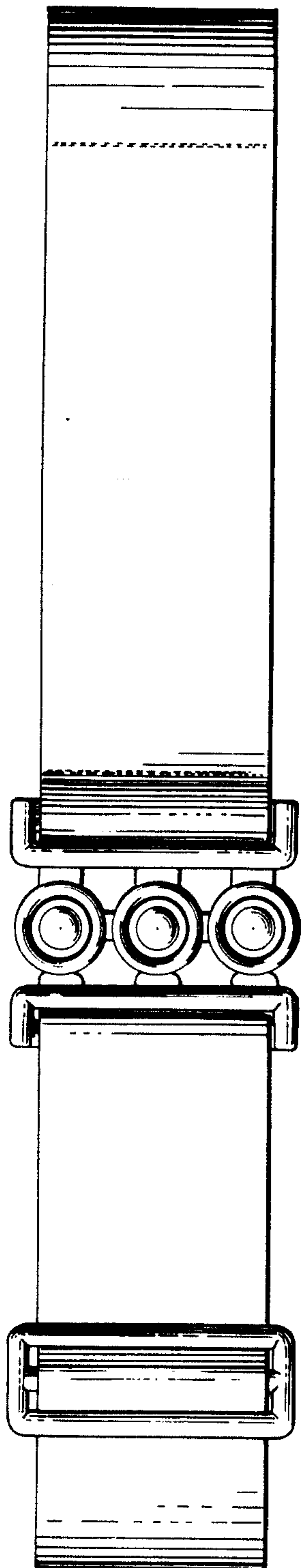

Fig-4

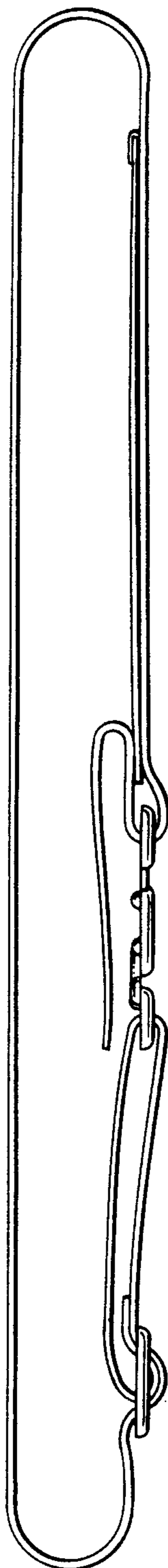

Fig-5

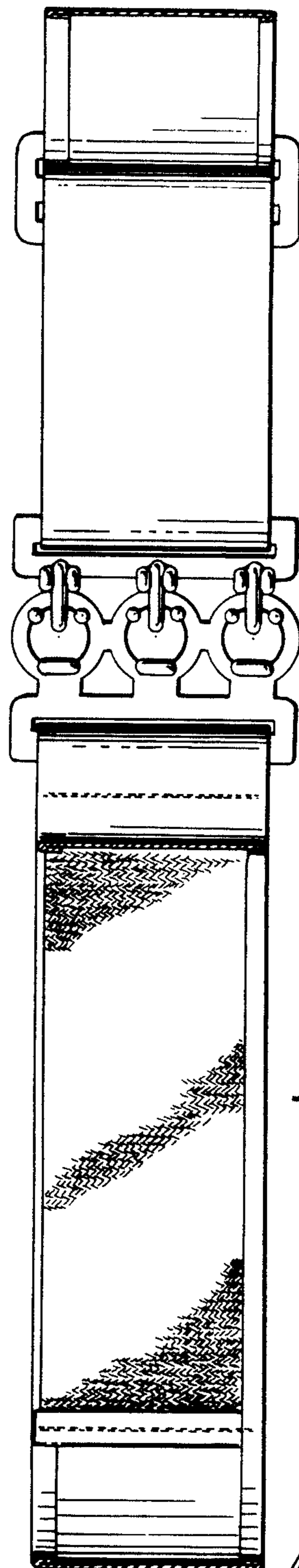

Fig-6

Fig-7

