

[54] COMBINED QUIVER AND MOUNT

[75] Inventor: Robert E. Stinson, Acme, Mich.

[73] Assignee: Kwikkee Kwiver Co., Inc., Acme, Mich.

[**] Term: 14 Years

[21] Appl. No.: 687,385

[22] Filed: May 17, 1976

[51] Int. Cl. D22-04

[52] U.S. Cl. D22/13

[58] Field of Search D22/13, 14; 150/1.5 R, 150/1.5 B, 1.5 C; 273/105.6

[56] References Cited

U.S. PATENT DOCUMENTS

D. 223,353	4/1972	Adams	D22/13
2,908,432	10/1959	Kent	150/1.5 R X
2,980,305	4/1961	Reese	150/1.5 R X
3,465,928	9/1969	Osterholm	224/1 B

3,591,062	7/1971	Karbo	224/1 B
3,777,734	12/1973	Rose	224/1 B

Primary Examiner—A. Hugo Word
Attorney, Agent, or Firm—Peter P. Price

[57] CLAIM

The ornamental design for a combined quiver and mount, substantially as shown and described.

DESCRIPTION

FIG. 1 is a perspective view of a combine quiver and mount design in accordance with the present invention; FIG. 2 is a top, plan view of the quiver; FIG. 3 is a side, elevational view of the quiver; FIG. 4 is a bottom, plan view of the quiver; FIG. 5 is a cross-sectional view taken generally along line V—V of FIG. 4; FIG. 6 is a rear, elevational view of the quiver; FIG. 7 is a front, elevational view of the quiver; FIG. 8 is a top, plan view of the mount; and FIG. 9 is a side, elevational view of the mount.

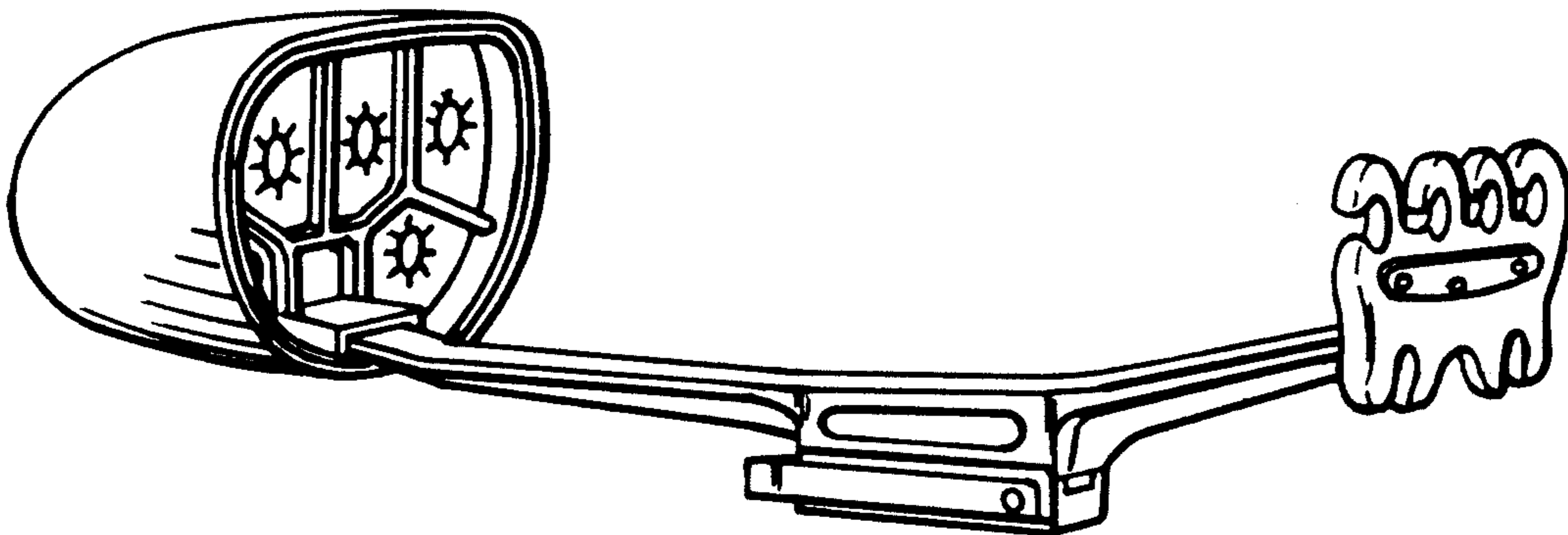

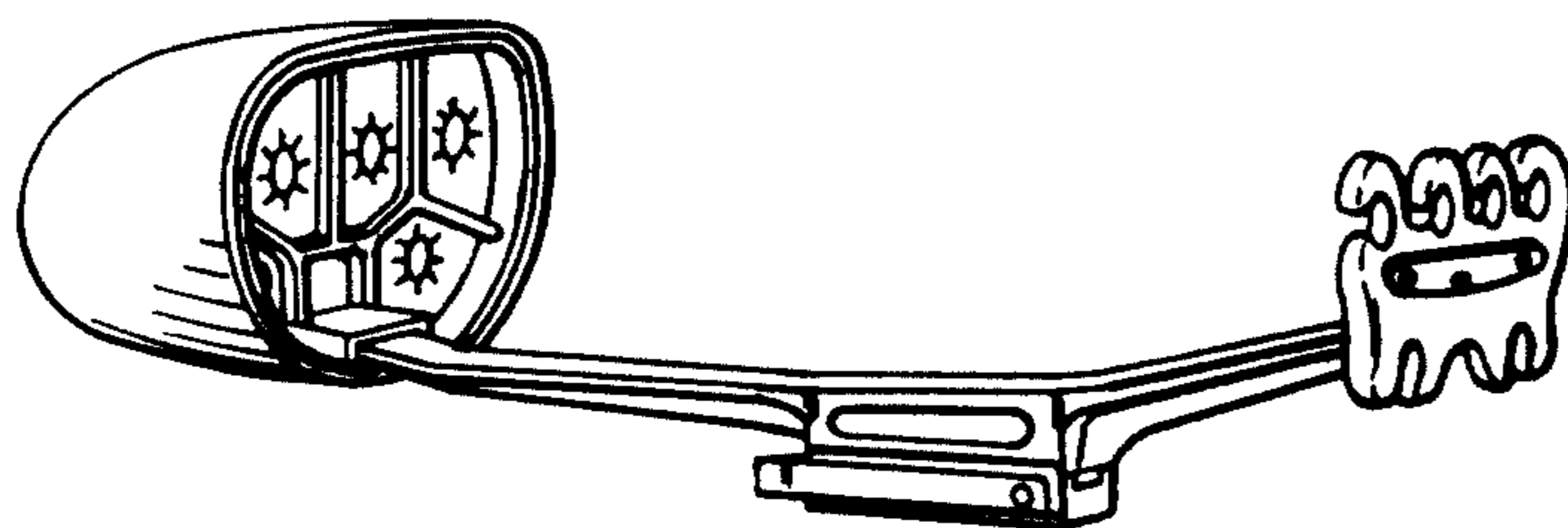

FIG. 1

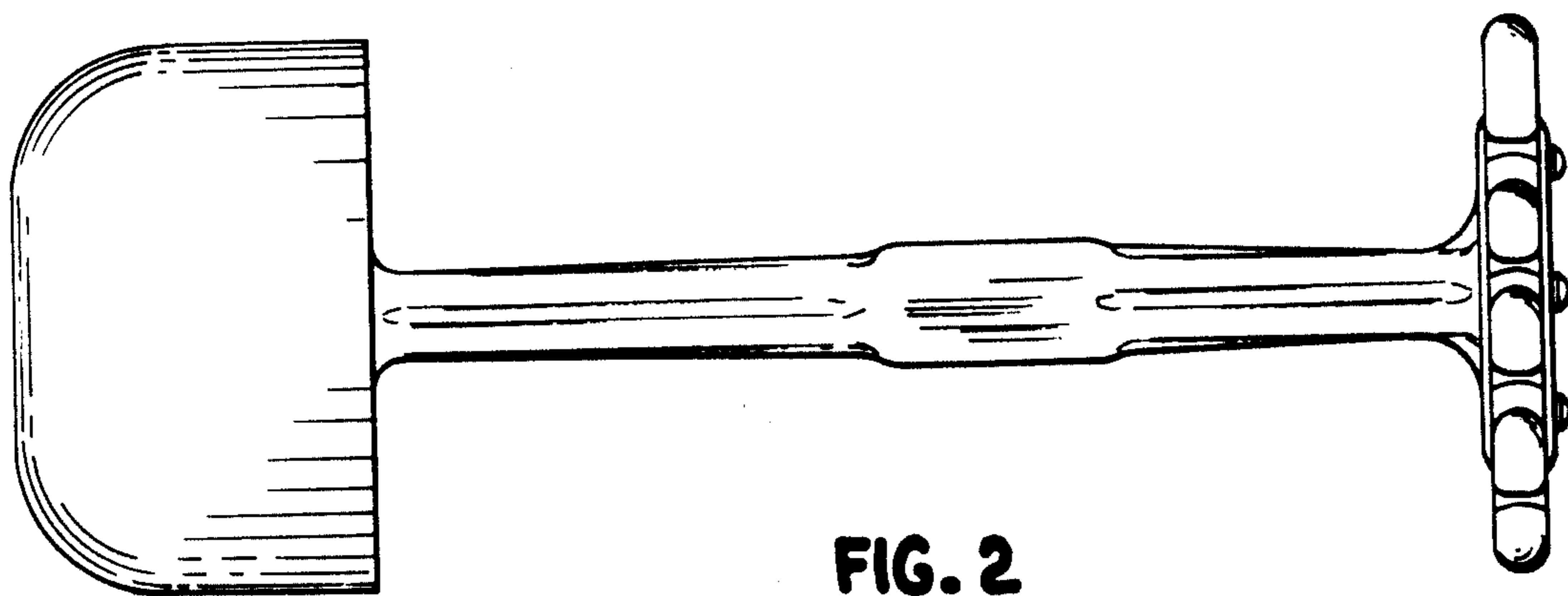

FIG. 2

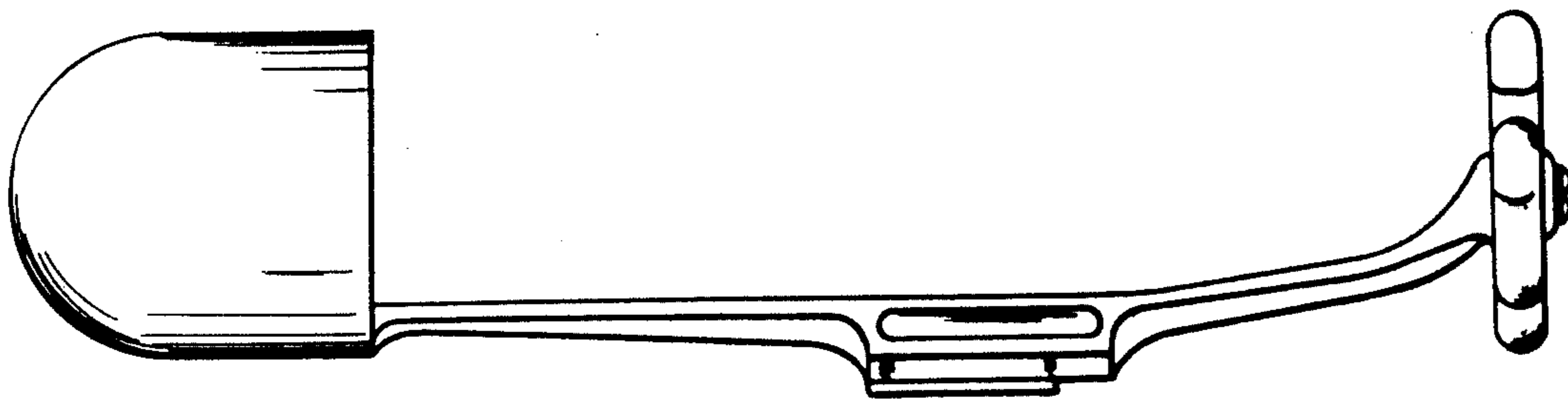

FIG. 3

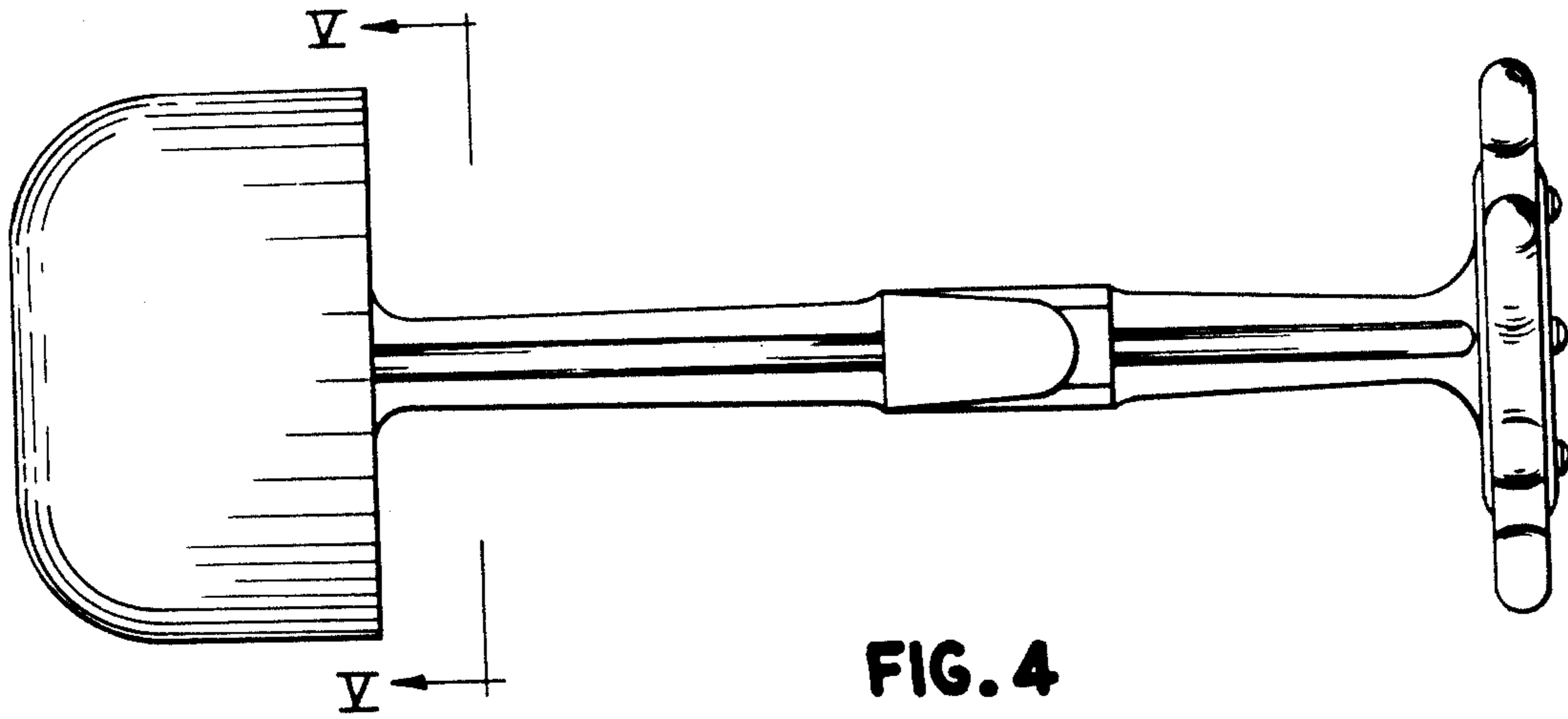

FIG. 4

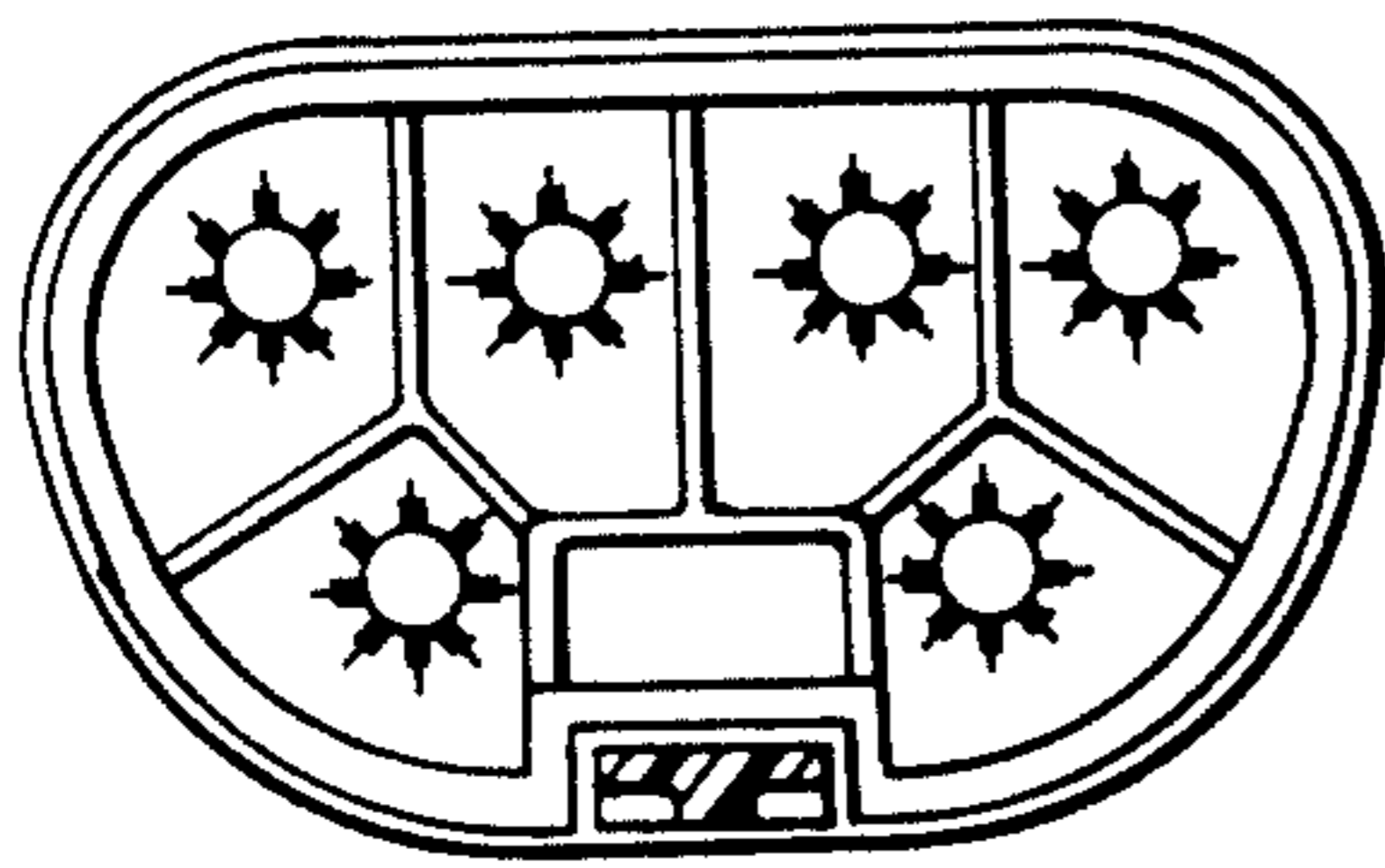

FIG. 5

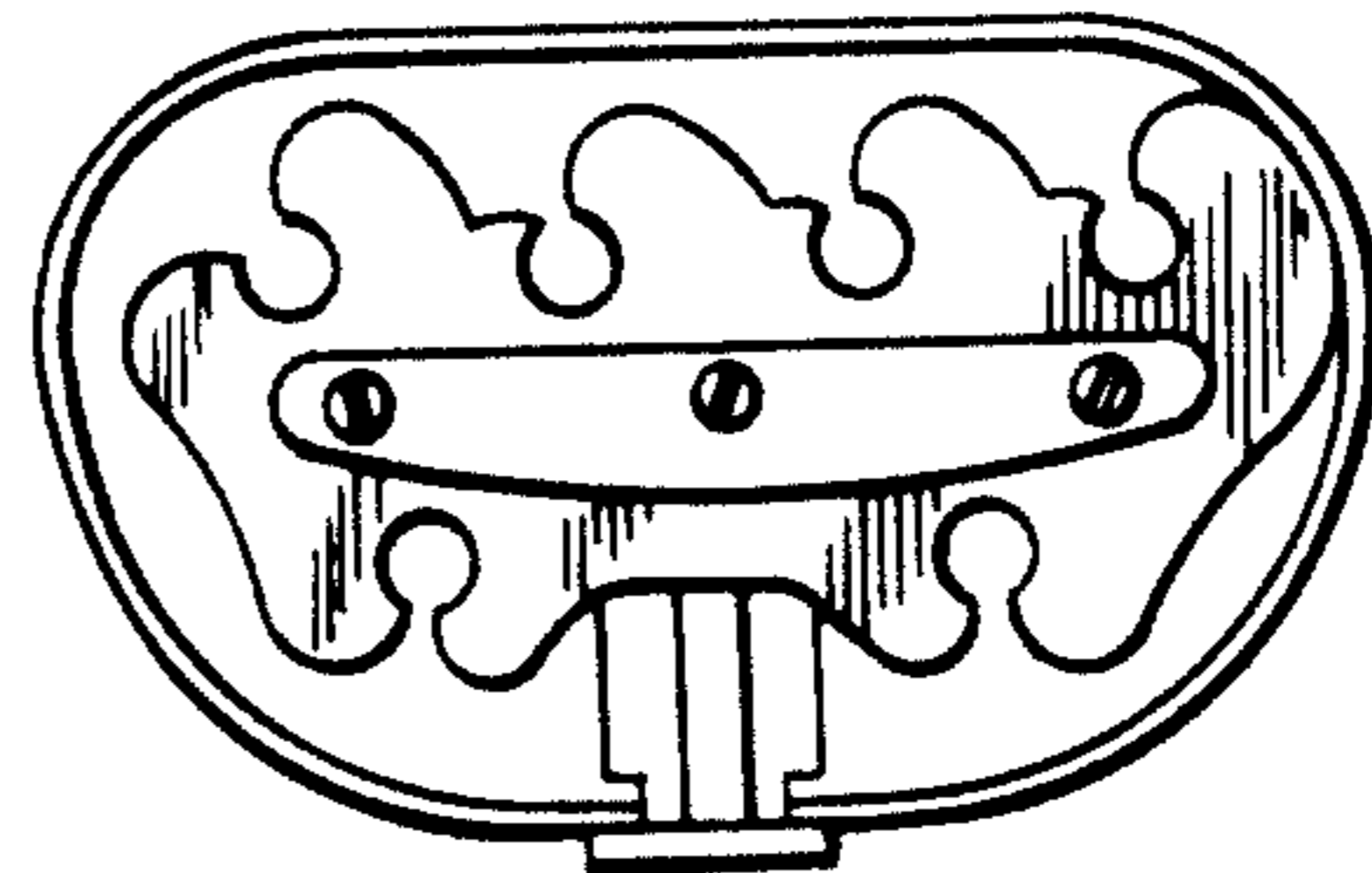

FIG. 6

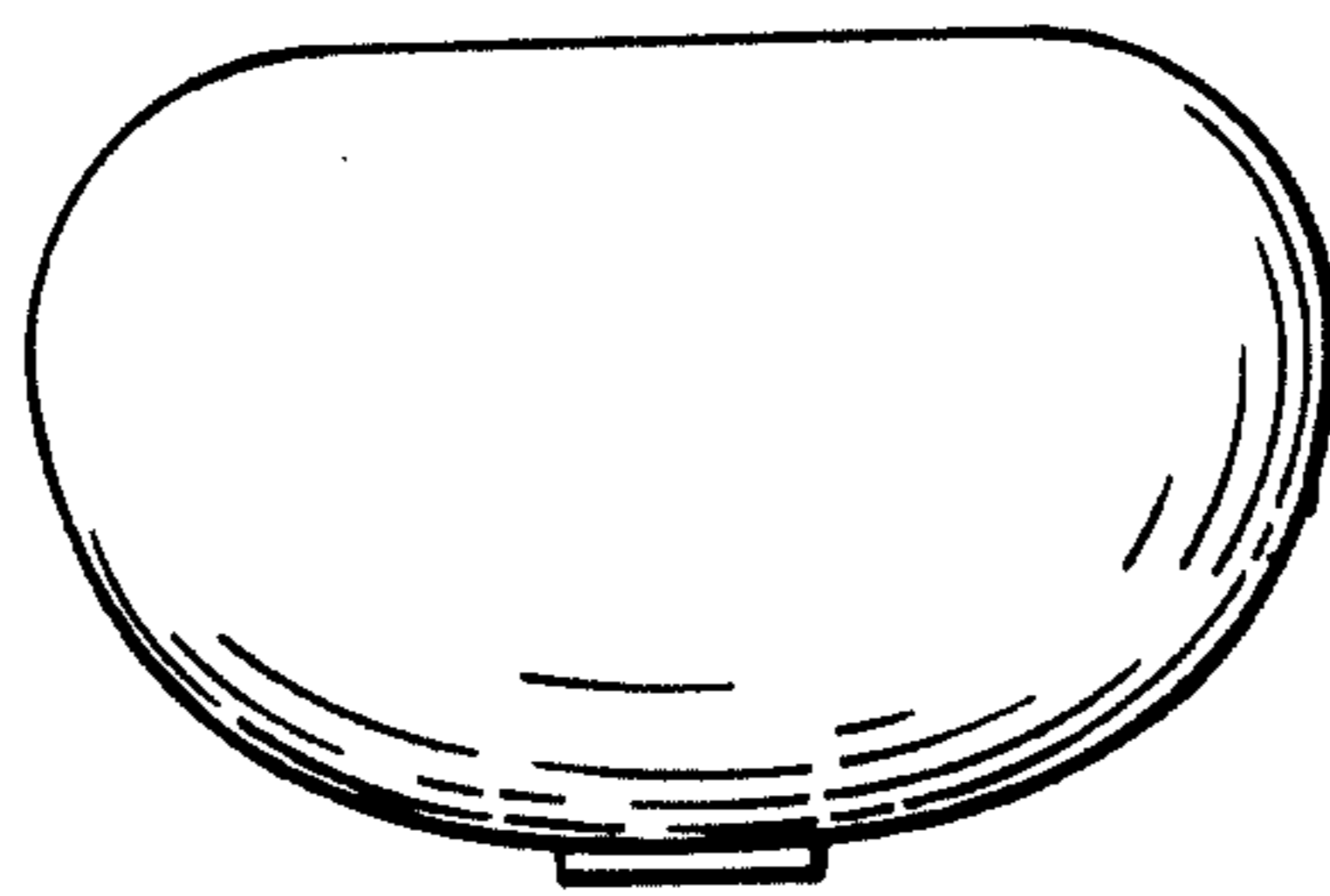

FIG. 7

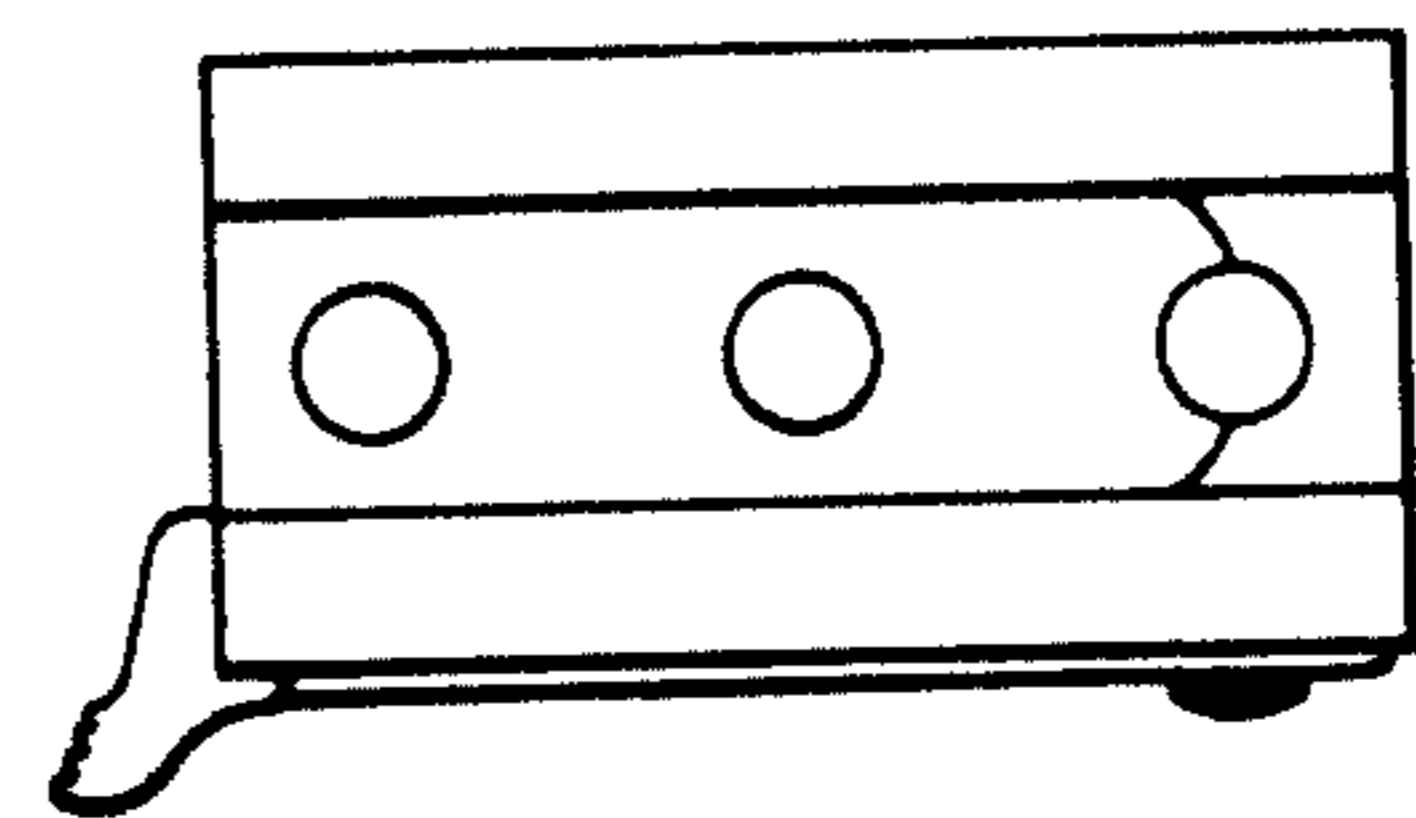

FIG. 8

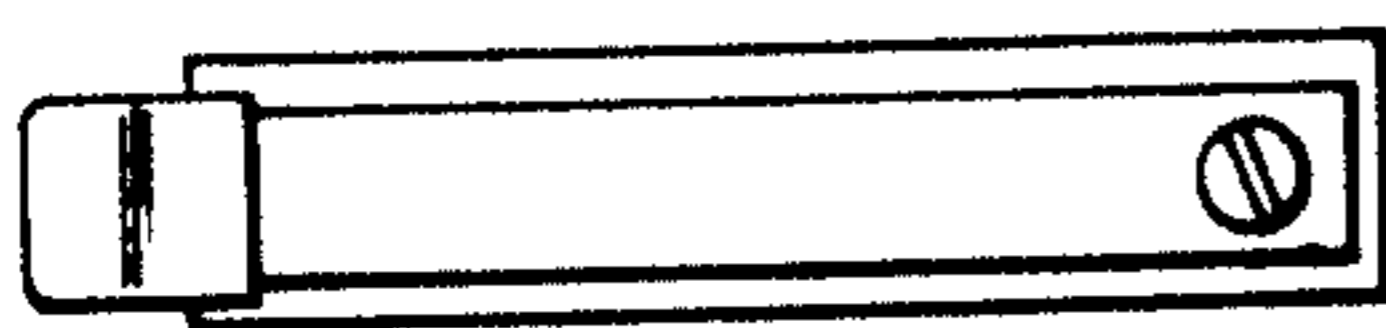

FIG. 9