

- [54] **POCKET AMUSEMENT DEVICE BOX**
- [75] Inventor: **Katsumi Sato**, Tokyo, Japan
- [73] Assignee: **Tomy Kogyo Co., Inc.**, Tokyo, Japan
- [**] Term: **14 Years**
- [21] Appl. No.: **724,076**
- [22] Filed: **Sep. 17, 1976**
- [51] Int. Cl. **D21-01**
- [52] U.S. Cl. **D34/5 JJ**
- [58] Field of Search **D34/5 JJ; 273/121 R,**
273/121 A, 1 L

- [56] **References Cited**
- U.S. PATENT DOCUMENTS**
- D. 243,780 3/1977 Yamagata **D34/5 JJ**
- FOREIGN PATENT DOCUMENTS**
- 317,508 11/1956 Switzerland **273/121 R**

OTHER PUBLICATIONS

F. A. O. Schwarz, Fall-Winter, 1975-1976, p. 29, middle right, item "D," Super Pinball.
Toys and Novelties, Apr. 15, 1967, p. 34, middle right, "Renezvous-in-Space."

Primary Examiner—Melvin B. Feifer
Attorney, Agent, or Firm—James D. Halsey, Jr.

[57] **CLAIM**

The ornamental design for a pocket amusement device box, as shown.

DESCRIPTION

FIG. 1 is a top plan view of a pocket amusement device box showing my new design;
FIG. 2 is a front elevational view thereof;
FIG. 3 is a rear elevational view thereof;
FIG. 4 is a right side elevational view thereof;
FIG. 5 is a left side elevational view thereof; and
FIG. 6 is a bottom plan view thereof.
FIG. 7 is a top perspective view thereof.

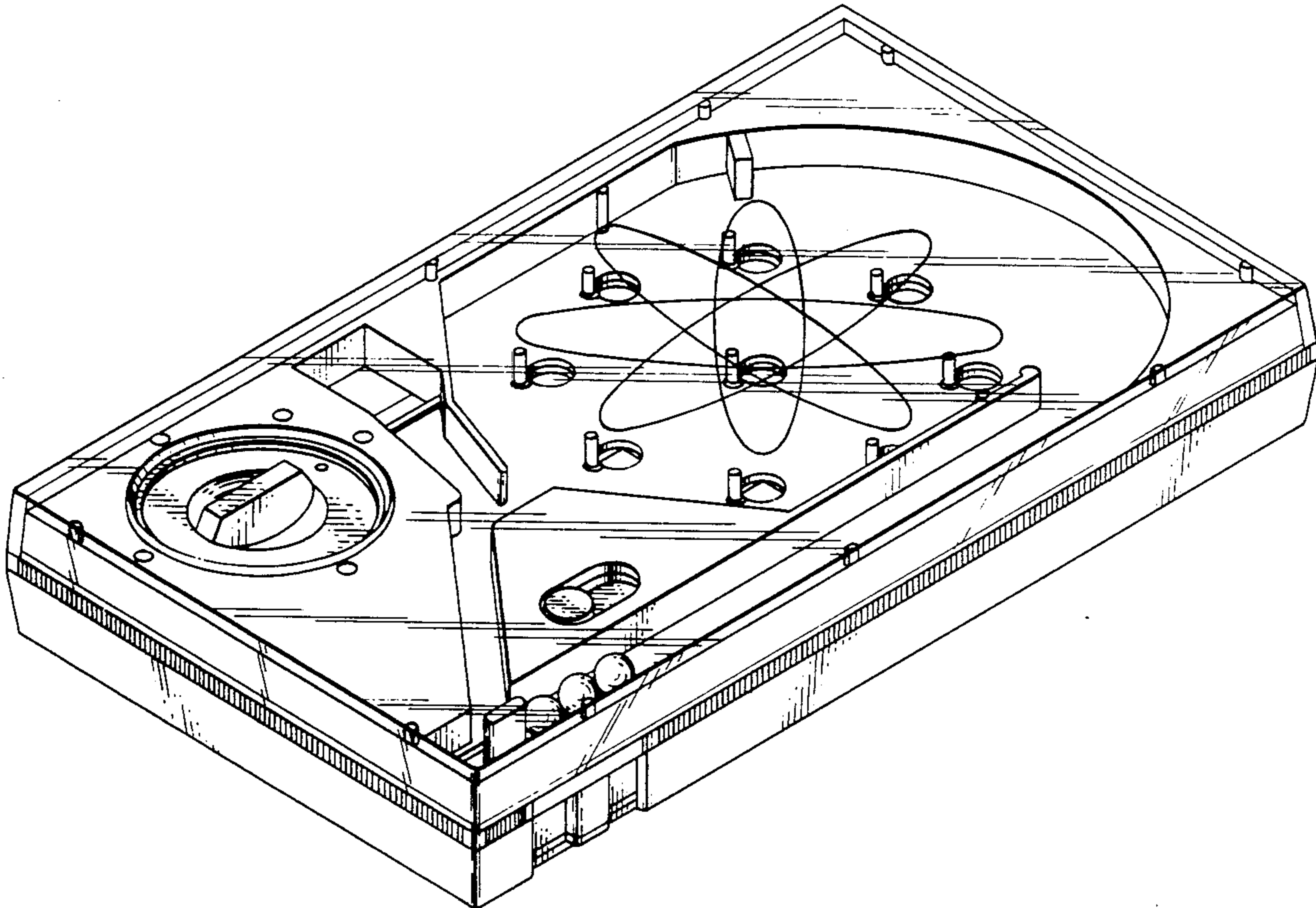

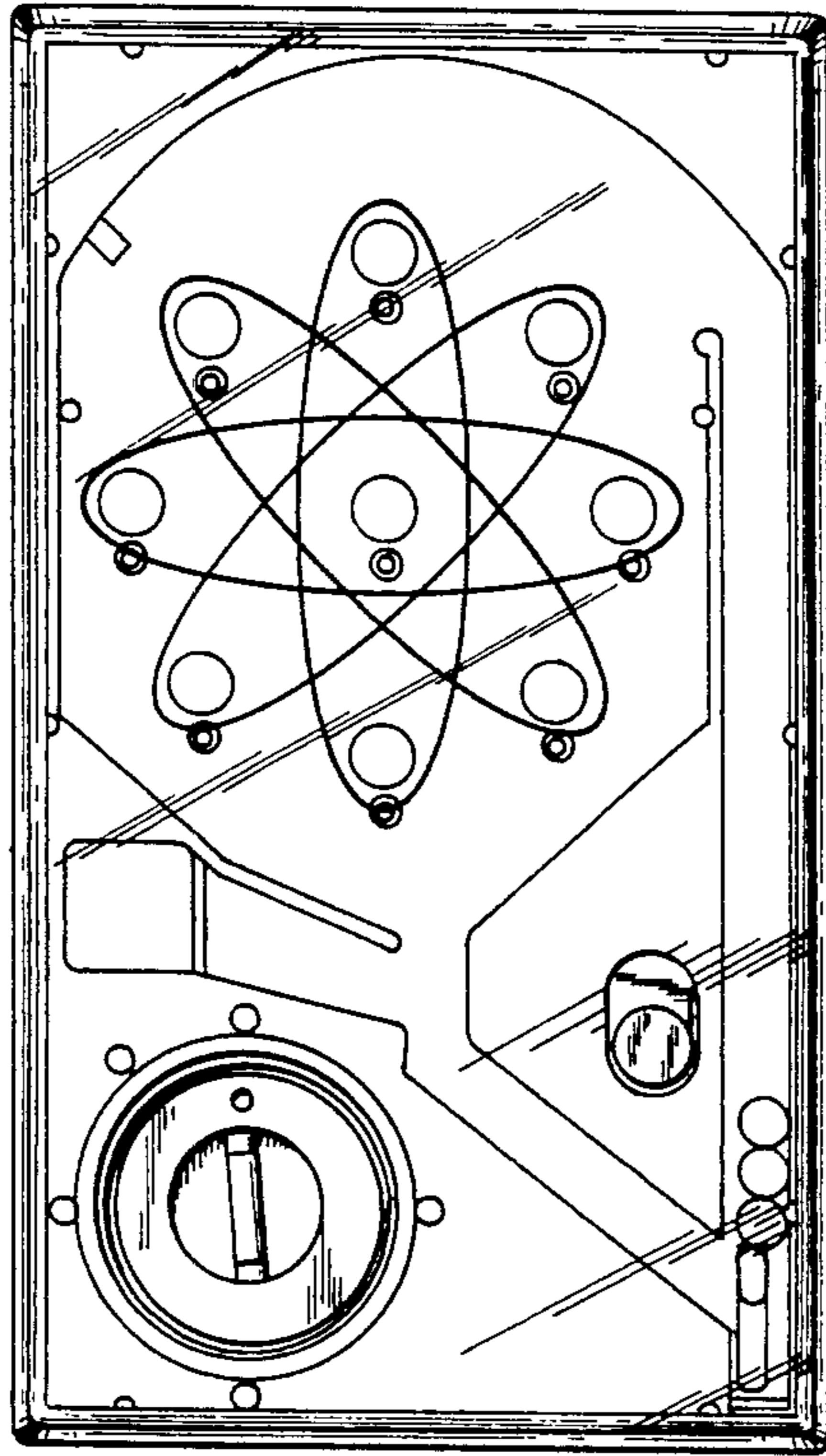

FIG. 1

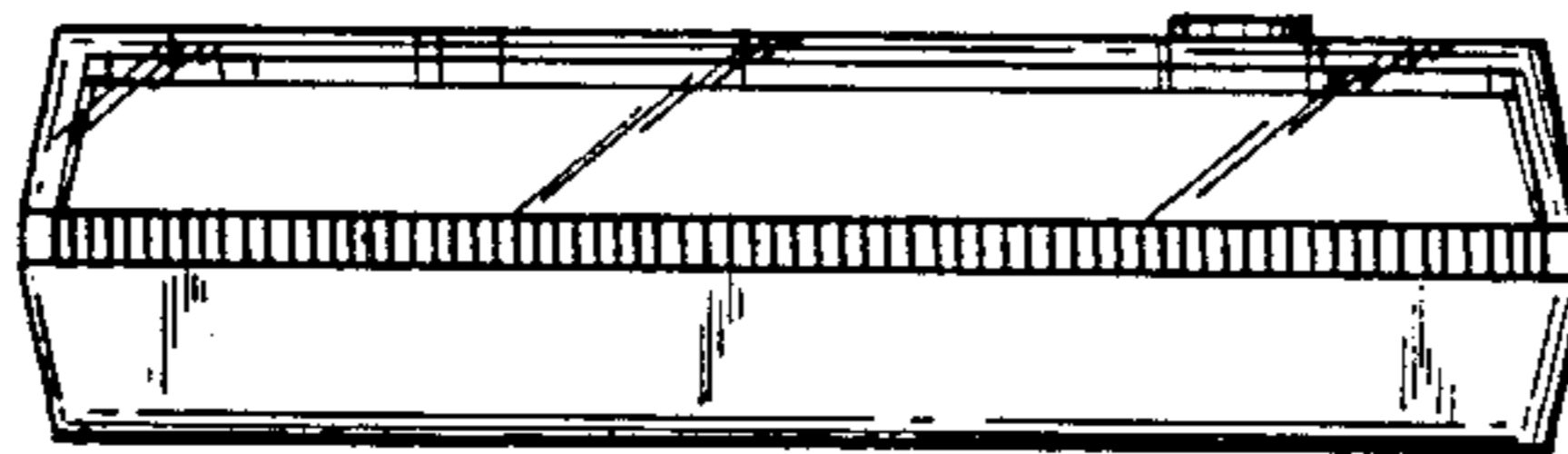

FIG. 2

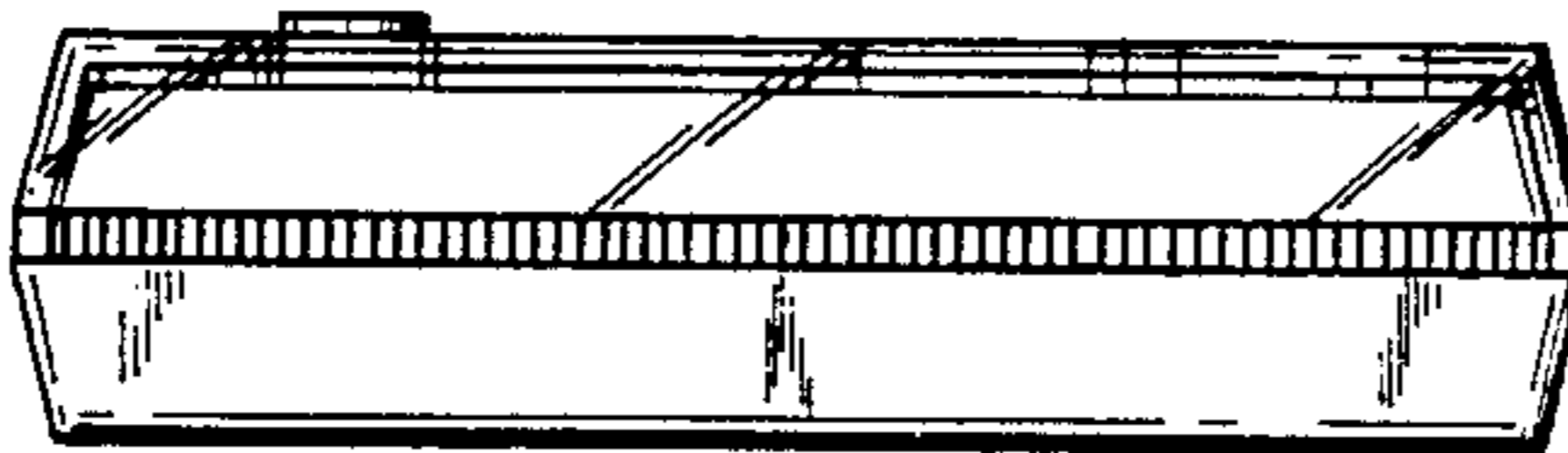

FIG. 3

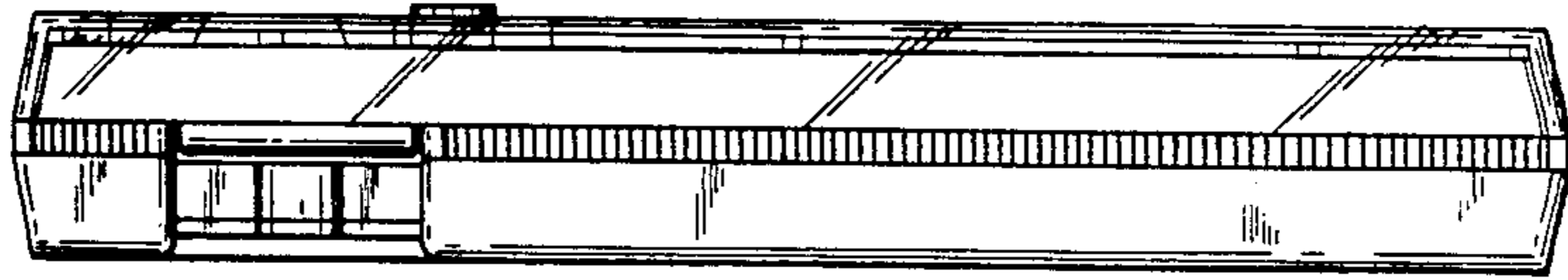

FIG. 4

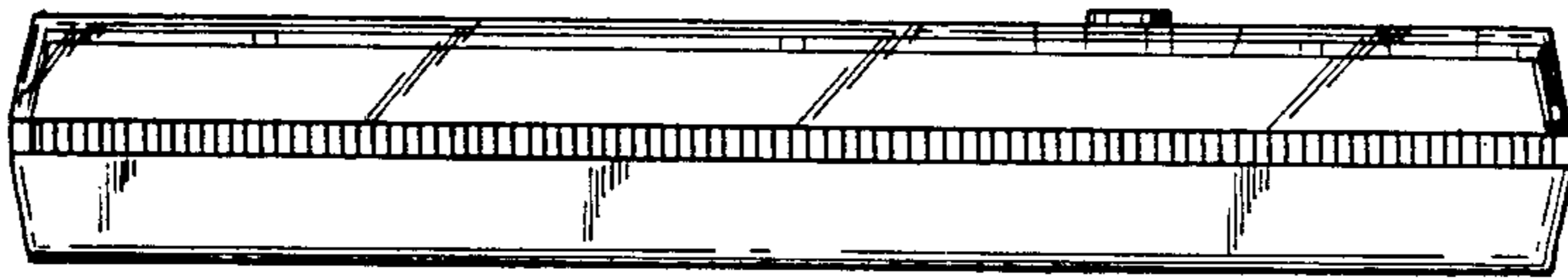

FIG. 5

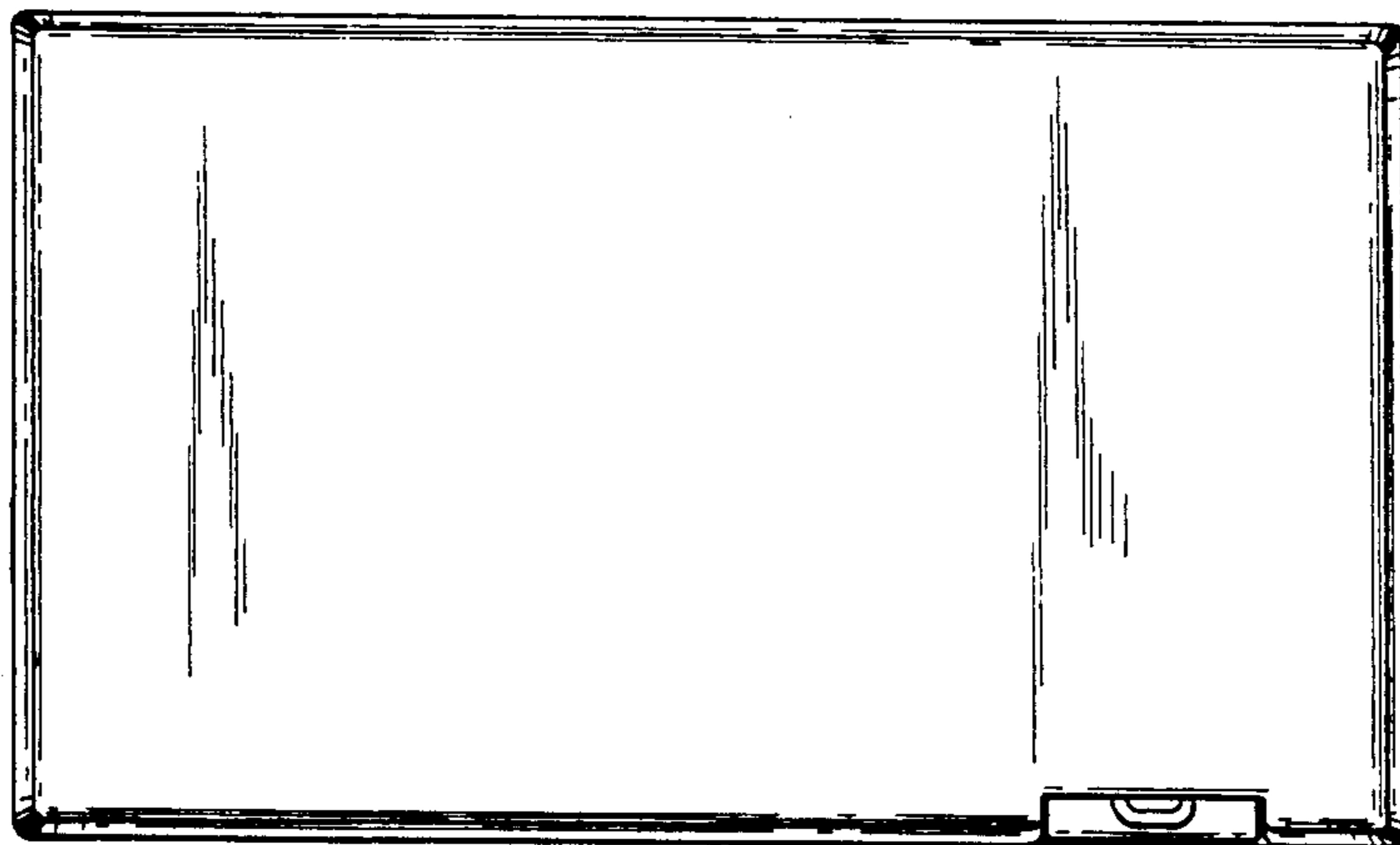

FIG. 6

FIG. 7

