

[54] FISH KNIFE

[76] Inventor: Robert A. Koob, 5904 Sunrise Dr., Minneapolis, Minn. 55419

[**] Term: 14 Years

[21] Appl. No.: 770,678

[22] Filed: Feb. 22, 1977

[51] Int. Cl. D22-02

[52] U.S. Cl. D22/1

[58] Field of Search D7/137, 150, 142; D8/45, 98, 102; D22/1, 31; 30/287

[56] References Cited

U.S. PATENT DOCUMENTS

- D. 178,437 7/1956 Walborn D8/102
- D. 229,659 12/1973 Murnan D22/31 X

- 1,408,368 2/1922 Lewis D8/98 X
- 2,538,435 1/1951 Wegner D22/31

Primary Examiner—A. Hugo Word
Attorney, Agent, or Firm—Everett J. Schroeder

[57] CLAIM

The ornamental design for a fish knife, as shown and described.

DESCRIPTION

FIG. 1 is a perspective view of my fish knife embodying my new design;
 FIG. 2 is a plan view;
 FIG. 3 is a right elevation view;
 FIG. 4 is a bottom view;
 FIG. 5 is a left elevation view;
 FIG. 6 is a rear view; and,
 FIG. 7 is a front view.

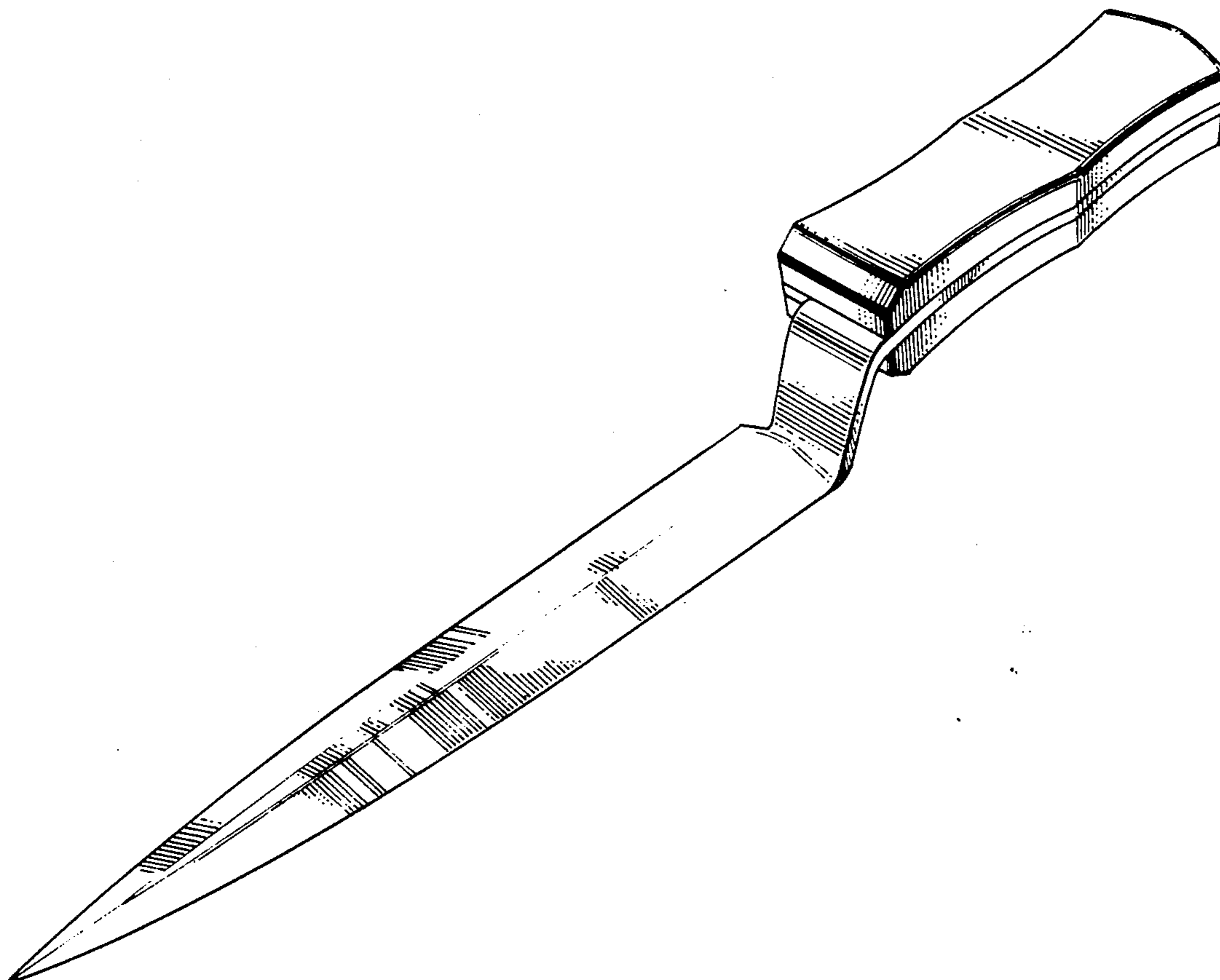

Fig. 6

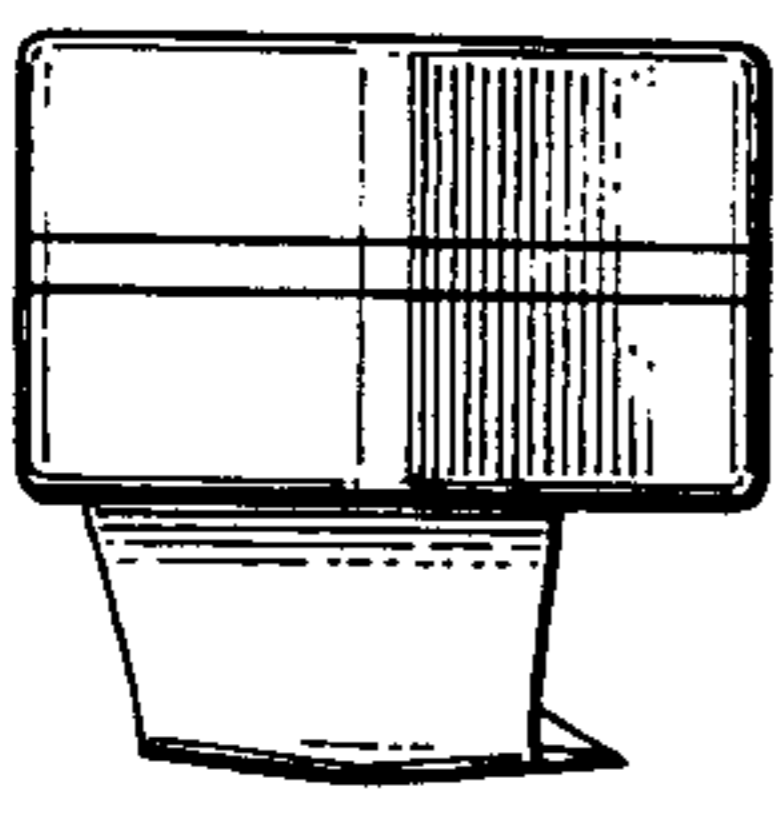

Fig. 1

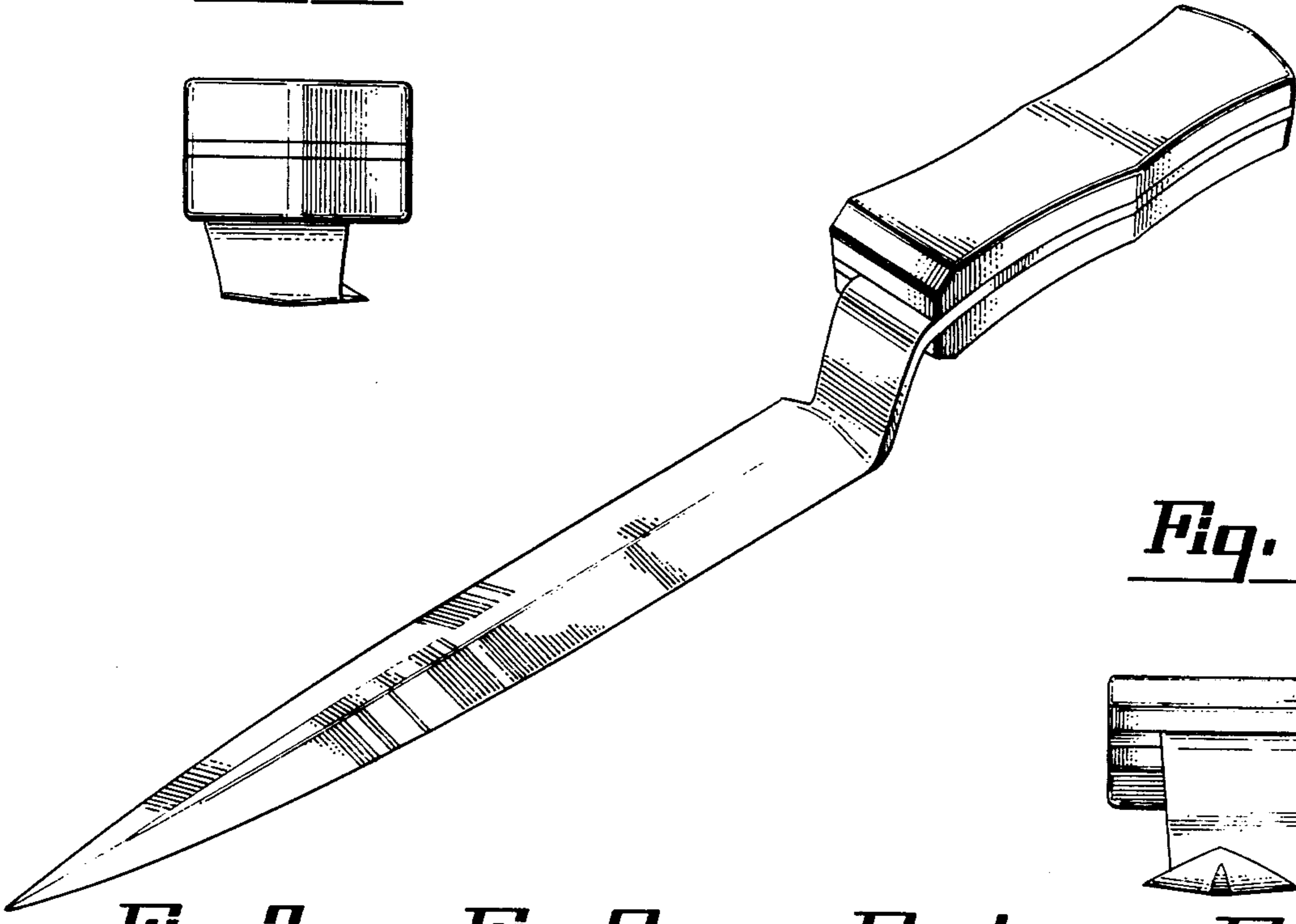

Fig. 7

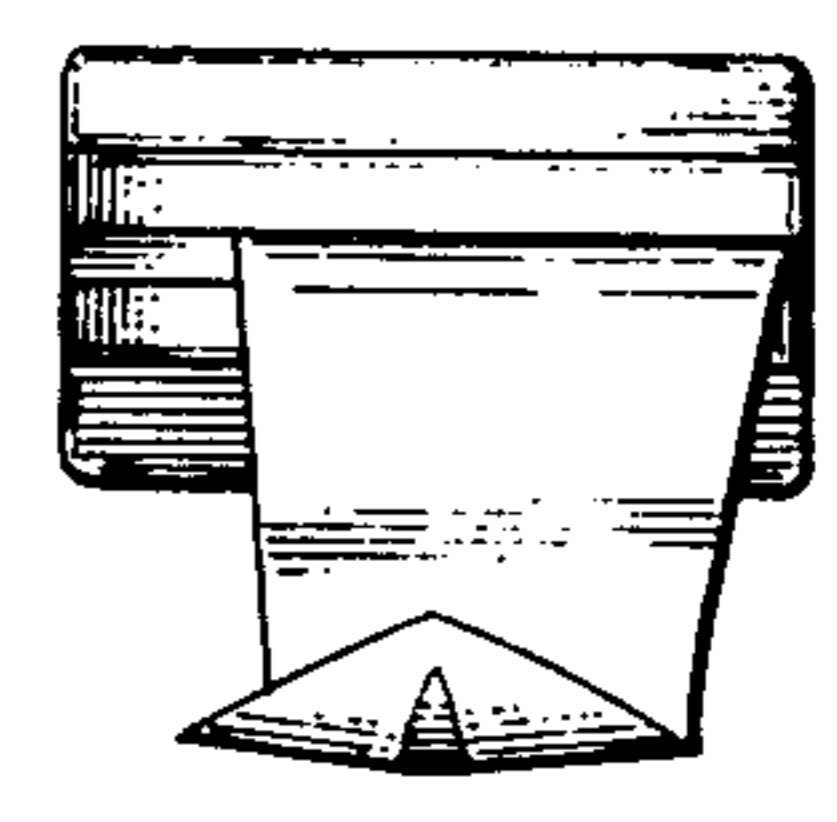

Fig. 2

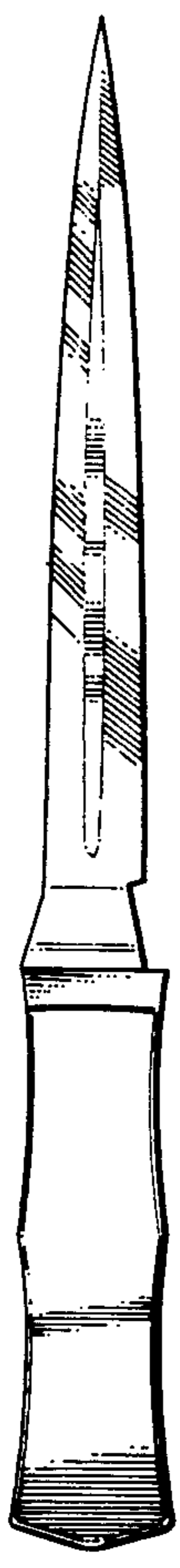

Fig. 3

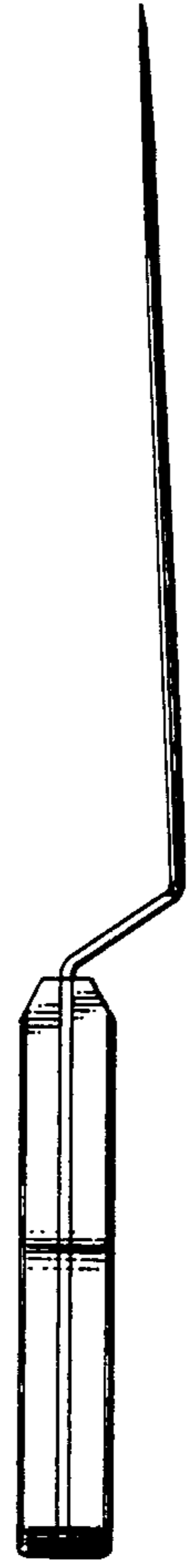

Fig. 4

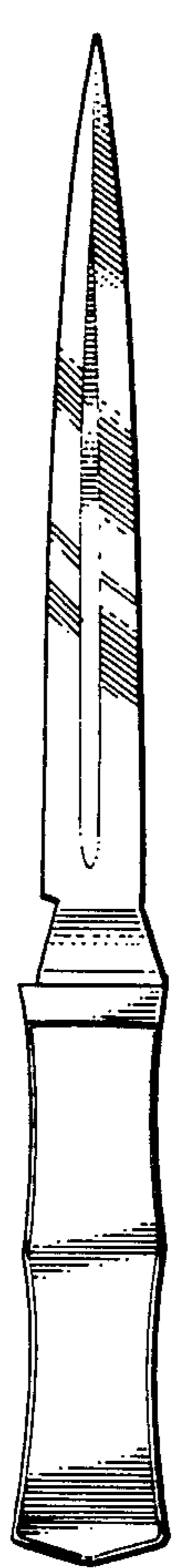

Fig. 5

