

[54] **AQUARIUM AIR PUMP**

[75] Inventors: **Allan H. Willinger; Harding W. Willinger; Monte L. Levin**, all of New York, N.Y.

[73] Assignee: **Willinger Bros., Inc.**, New York, N.Y.

[**] Term: **14 Years**

[21] Appl. No.: **759,775**

[22] Filed: **Jan. 17, 1977**

Related U.S. Application Data

[63] Continuation-in-part of Ser. No. D. 709,546, July 28, 1976.

[51] Int. Cl. **D15-02**

[52] U.S. Cl. **D15/8**

[58] Field of Search **D15/7-9;**
417/413, 424

[56] **References Cited**

U.S. PATENT DOCUMENTS

D. 207,363	4/1967	Lovitz	D15/8
D. 215,765	10/1969	Levin	D15/8
D. 224,355	7/1972	Kondo	D15/8
D. 224,356	7/1972	Kondo	D15/8
D. 227,506	6/1973	Kondo	D15/8
D. 227,507	6/1973	Kondo	D15/8
3,671,151	6/1972	Duke et al.	417/413
3,825,374	7/1974	Kondo	417/413

3,830,596 8/1974 Kondo 417/413

Primary Examiner—James R. Largen
Attorney, Agent, or Firm—Abraham Friedman

[57] **CLAIM**

The ornamental design for an aquarium air pump, substantially as shown and described.

DESCRIPTION

FIG. 1 is a perspective view taken from the front and left side of an aquarium air pump, showing our new design;

FIG. 2 is a top plan view thereof;

FIG. 3 is a bottom plan view thereof;

FIG. 4 is a right side elevational view thereof;

FIG. 5 is a rear elevational view thereof;

FIG. 6 is a perspective view taken from the front and left side of a modified form of the aquarium air pump as shown in FIG. 1;

FIG. 7 is a top plan view of FIG. 6;

FIG. 8 is a bottom plan view of FIG. 6;

FIG. 9 is a right side elevational view of FIG. 6;

FIG. 10 is a rear elevational view of FIG. 6;

FIG. 11 is a perspective view taken from the front and left side of a second modified form of the aquarium air pump shown in FIG. 1;

FIG. 12 is a top plan view of FIG. 11;

FIG. 13 is a bottom plan view of FIG. 11;

FIG. 14 is a right side elevational view of FIG. 11; and

FIG. 15 is a rear elevational view of FIG. 11.

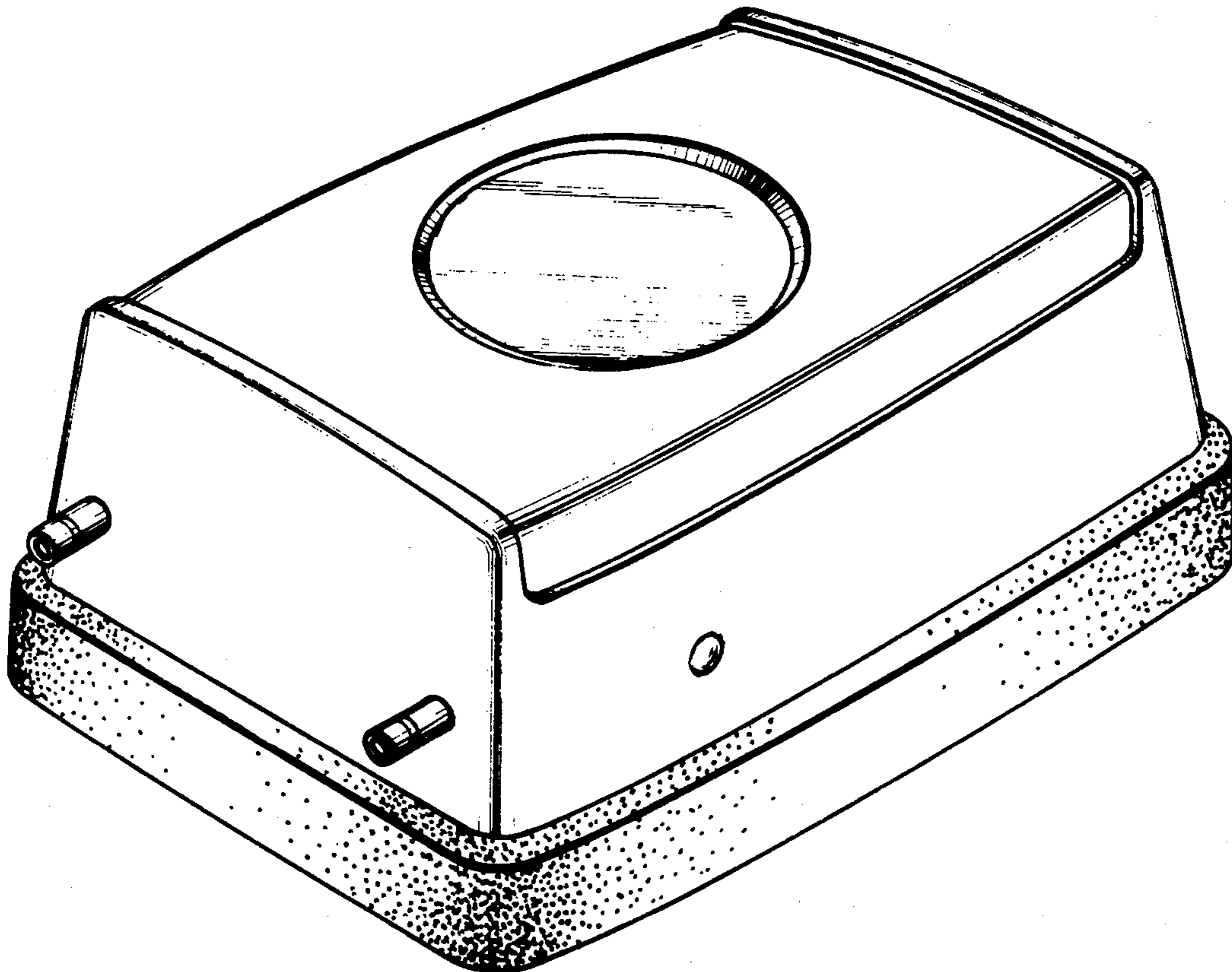

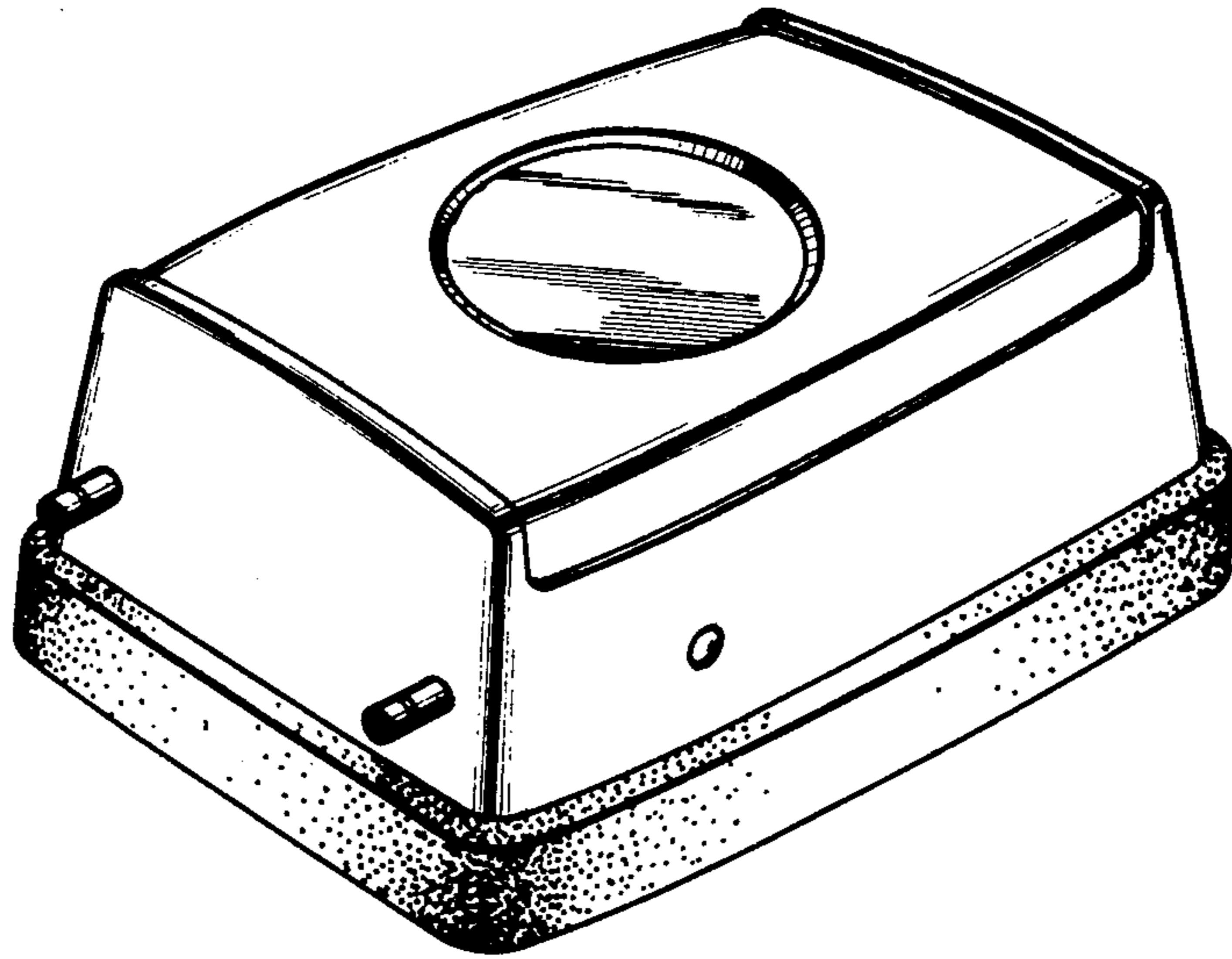

FIG. 1

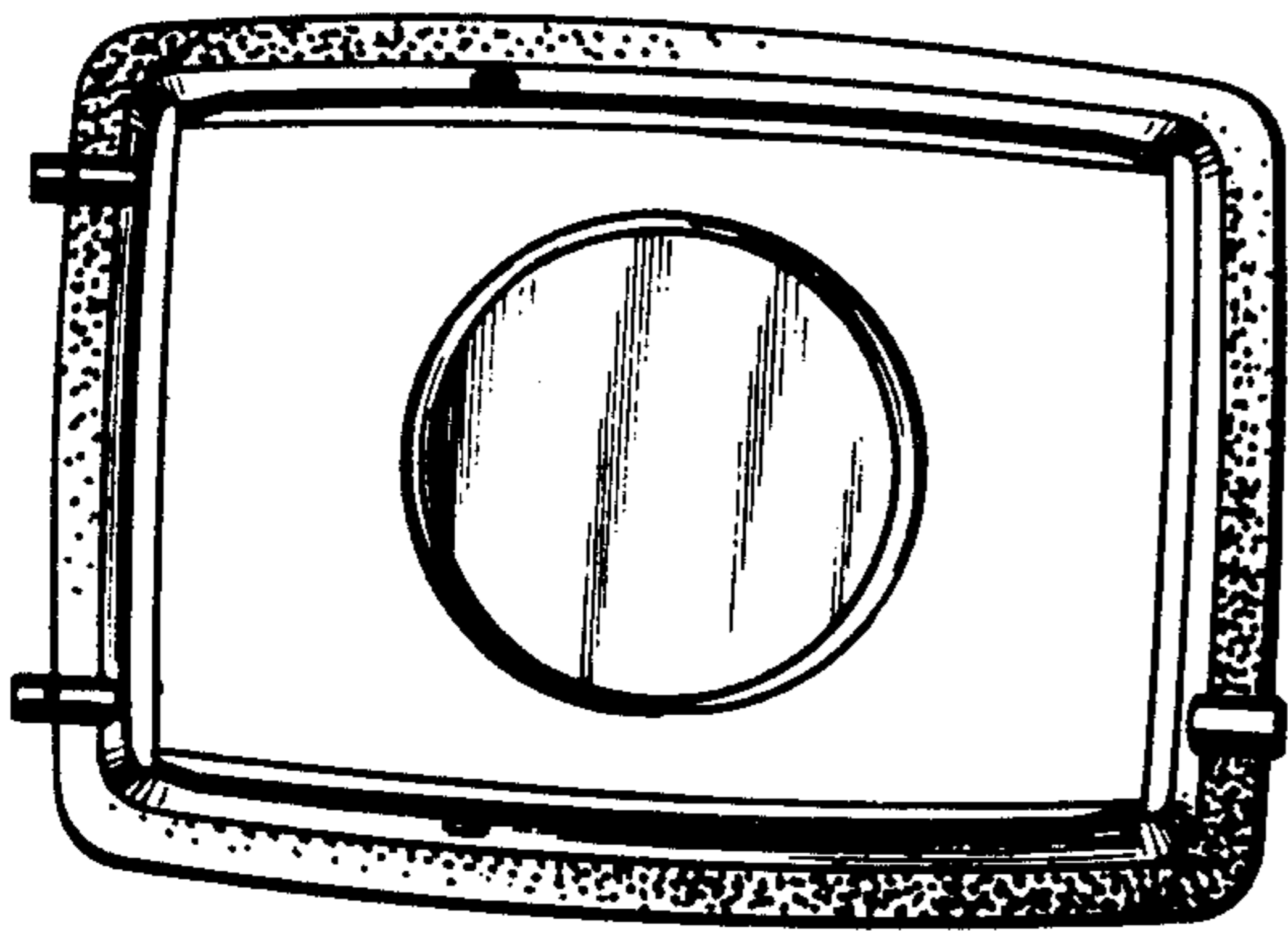

FIG. 2

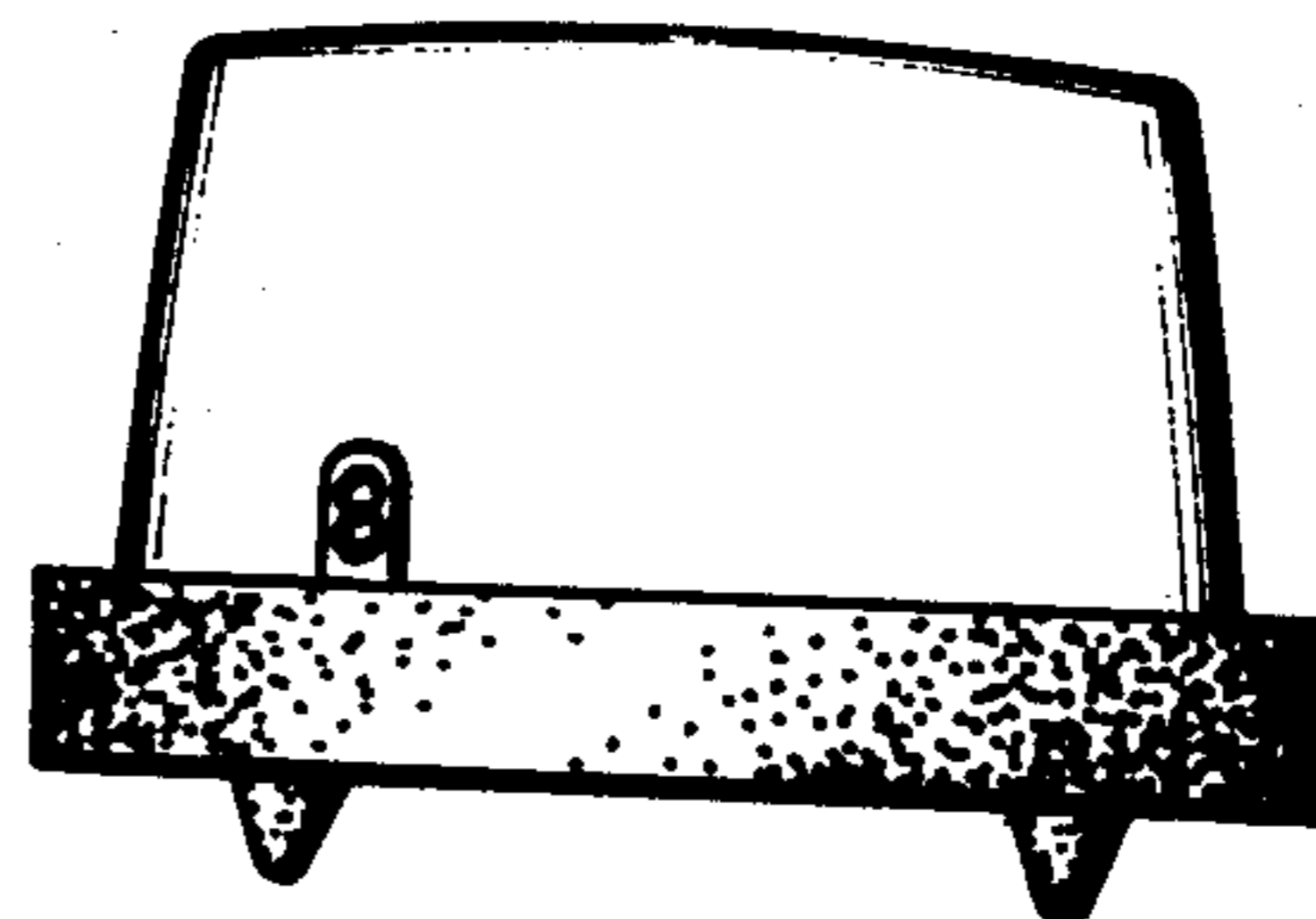

FIG. 4

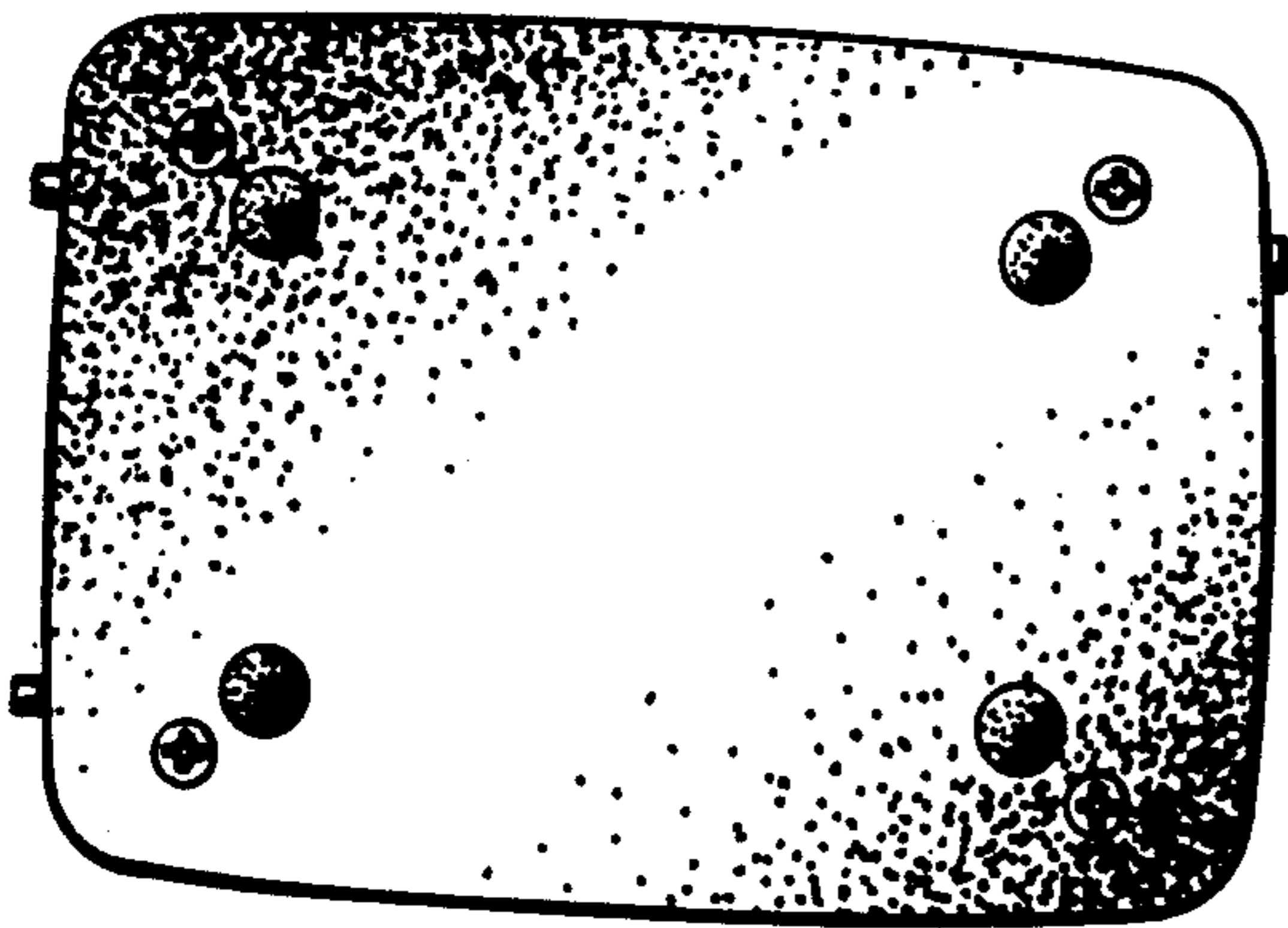

FIG. 3

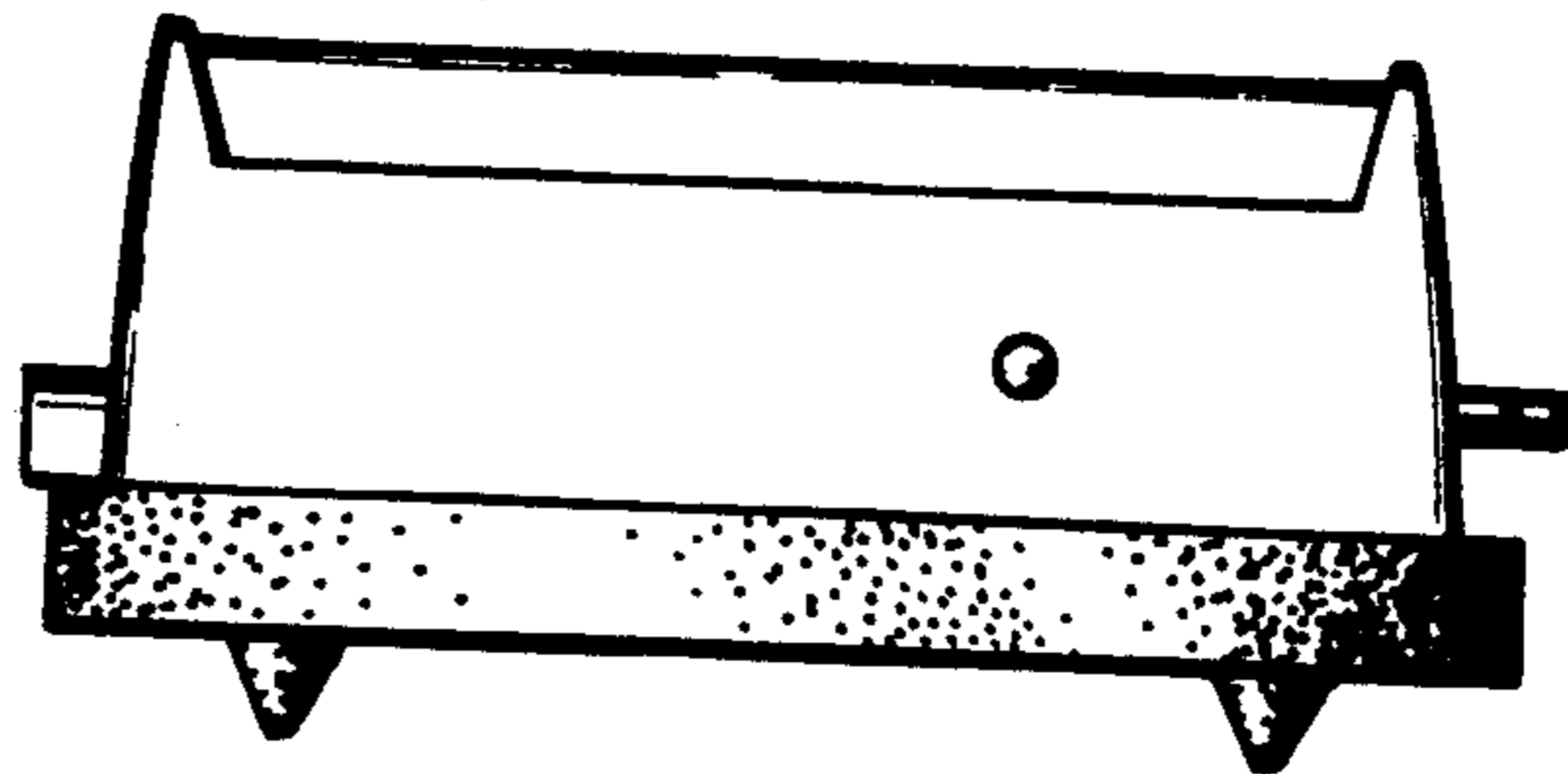

FIG. 5

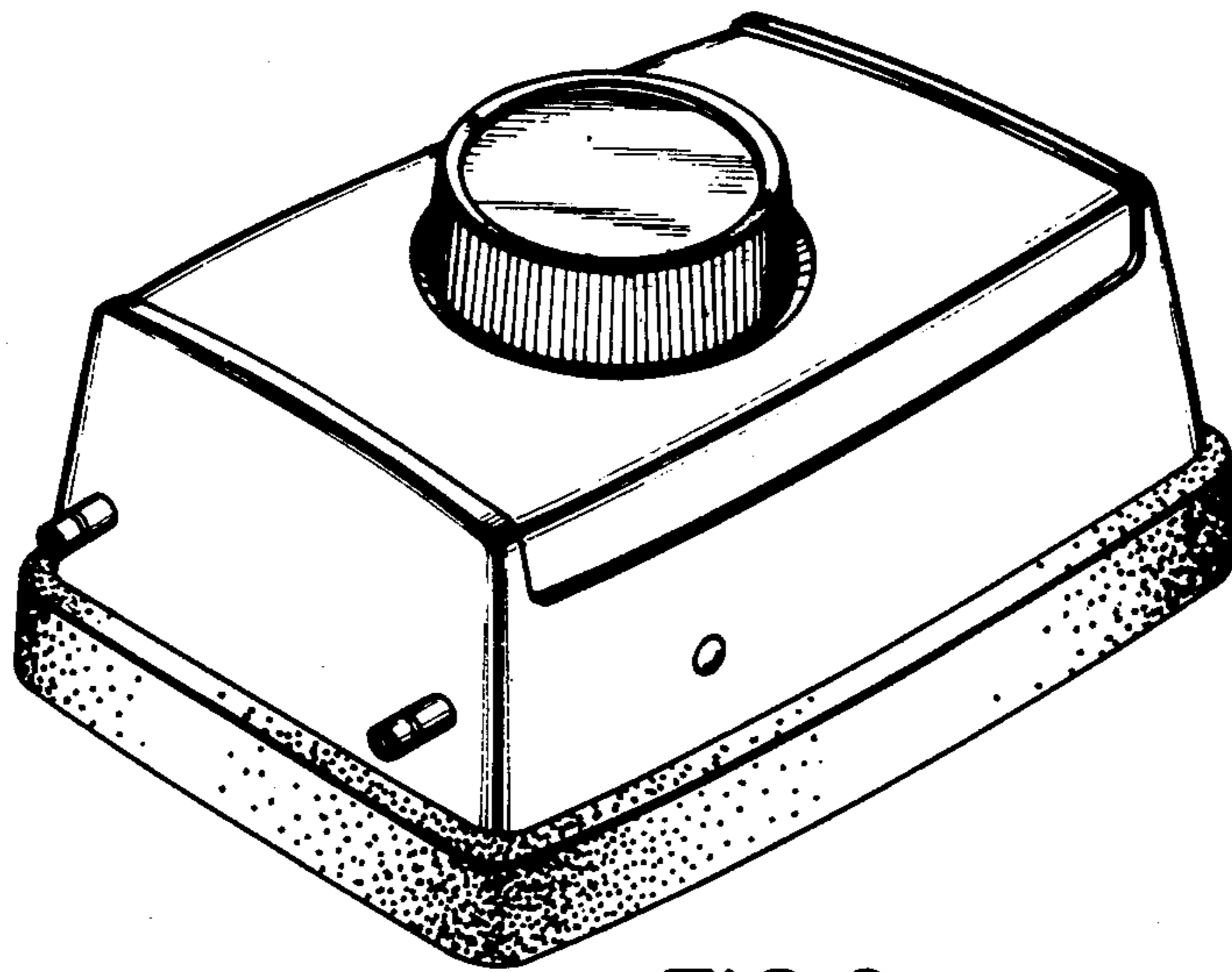

FIG. 6

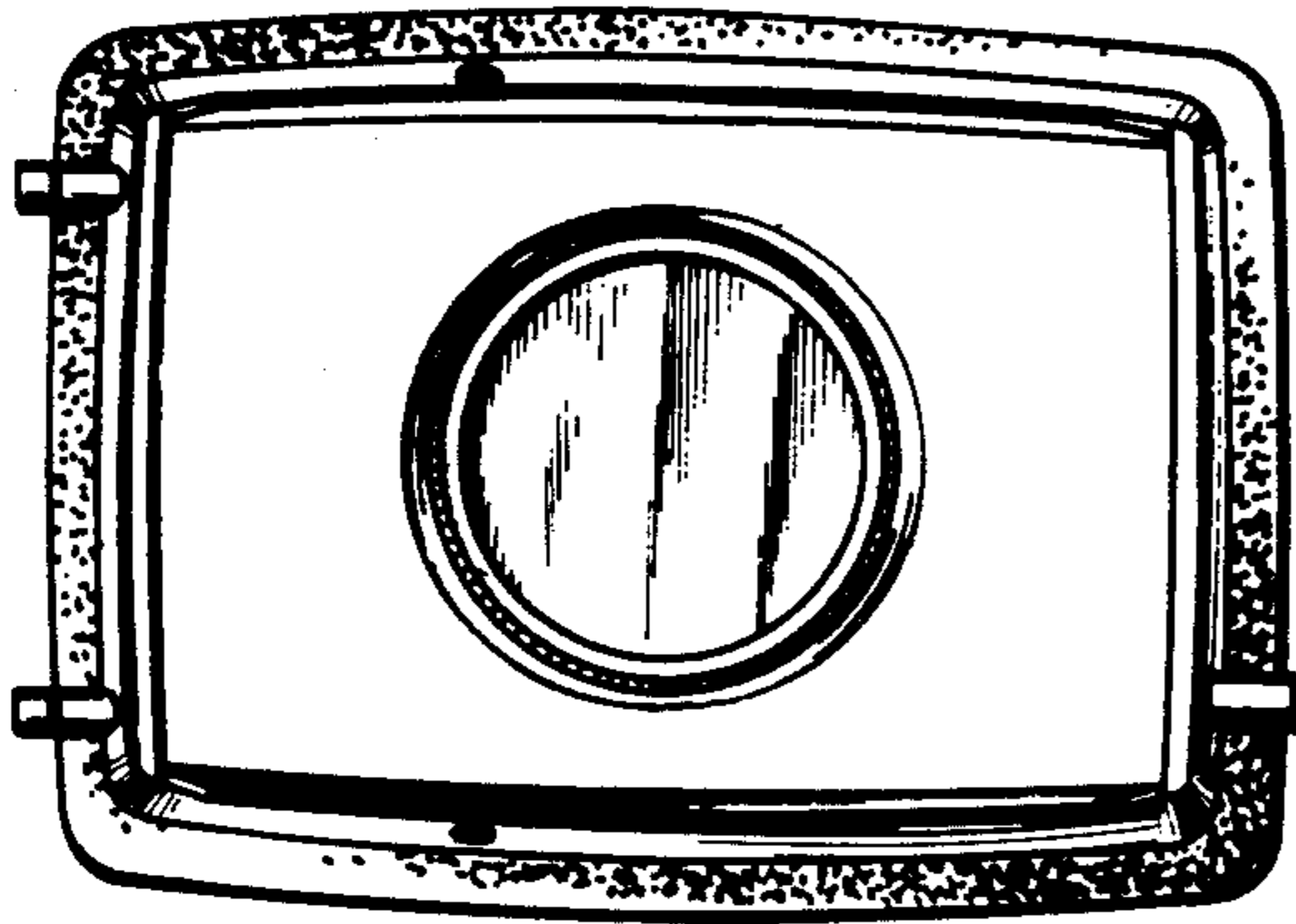

FIG. 7

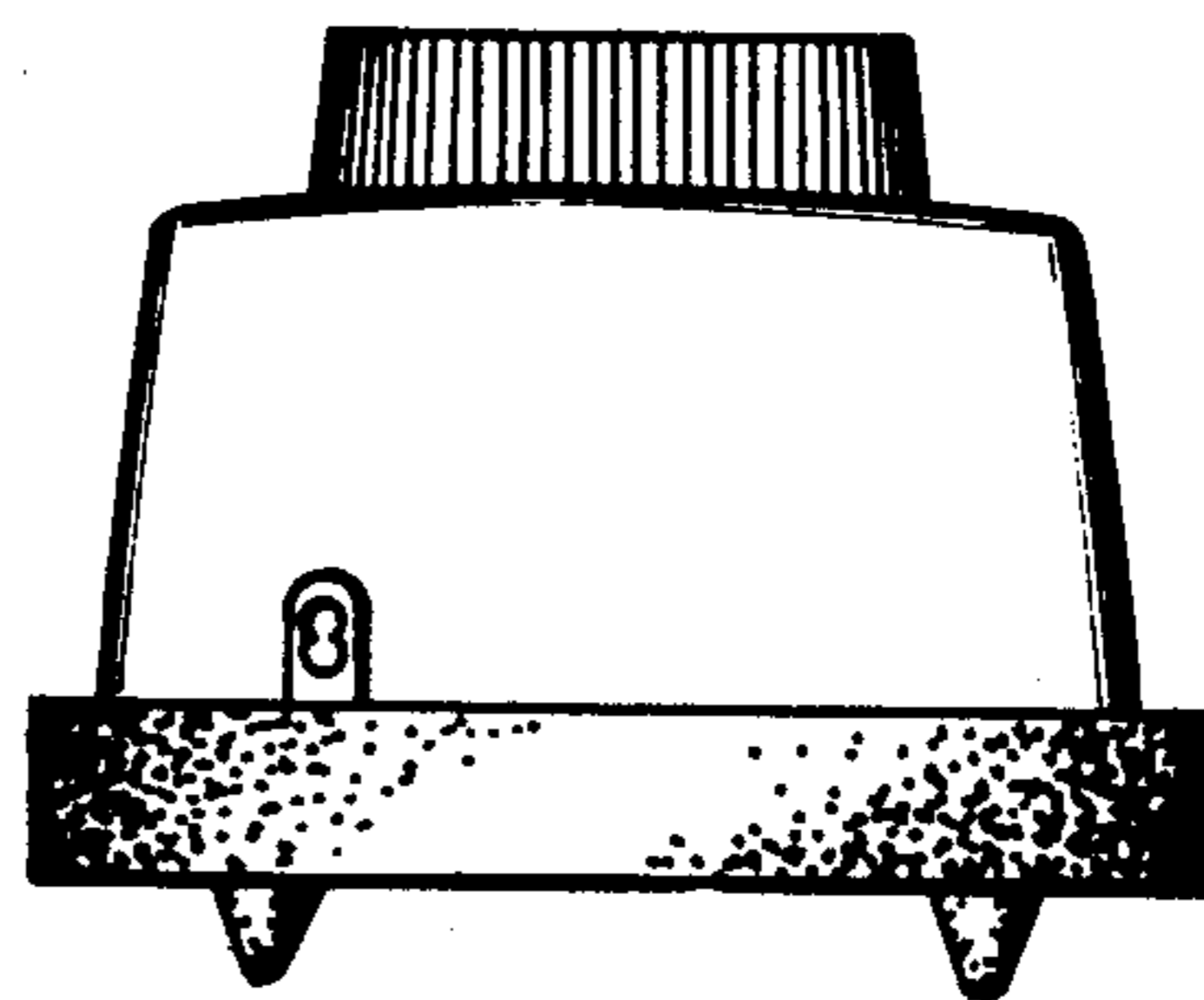

FIG. 9

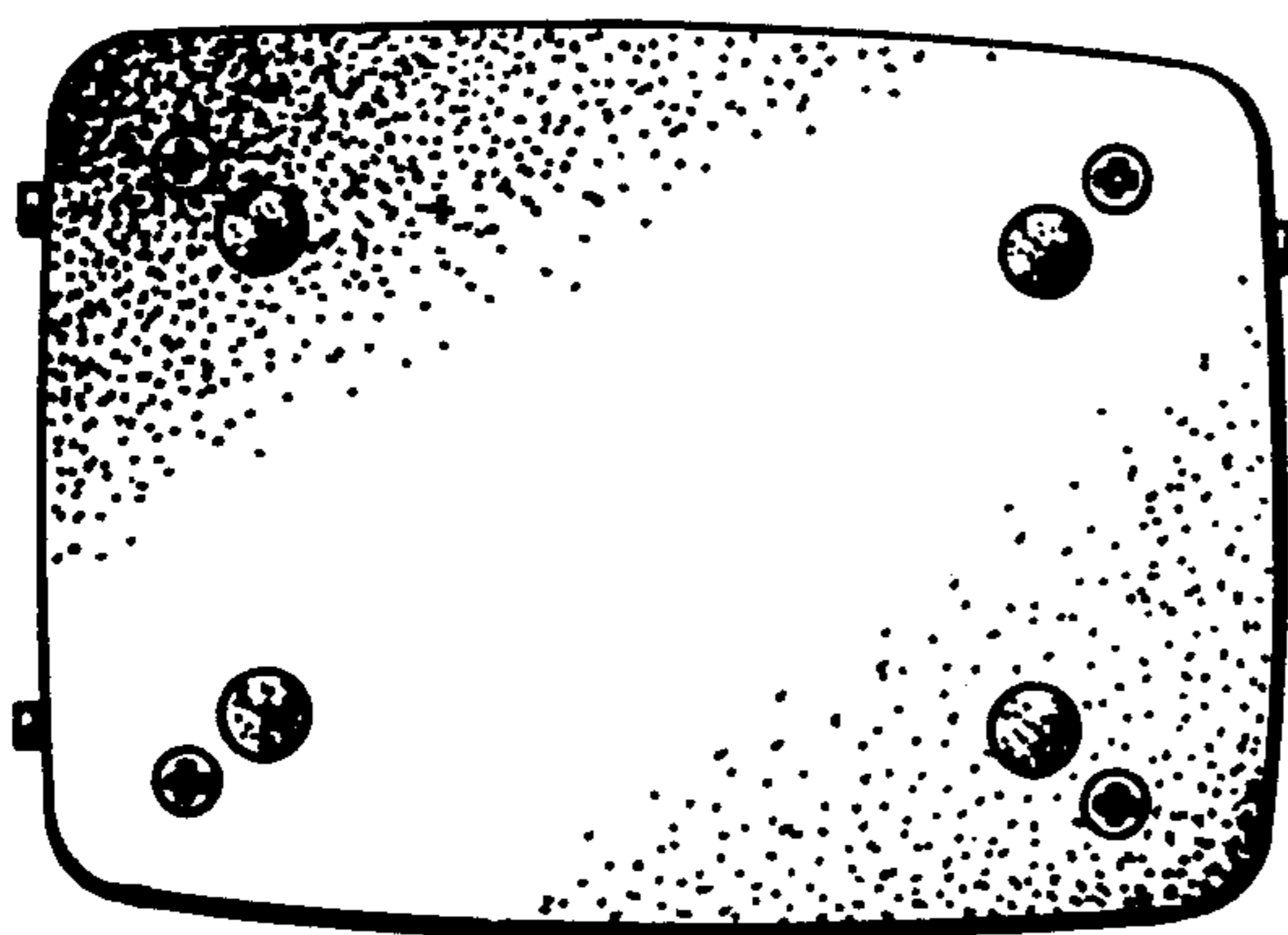

FIG. 8

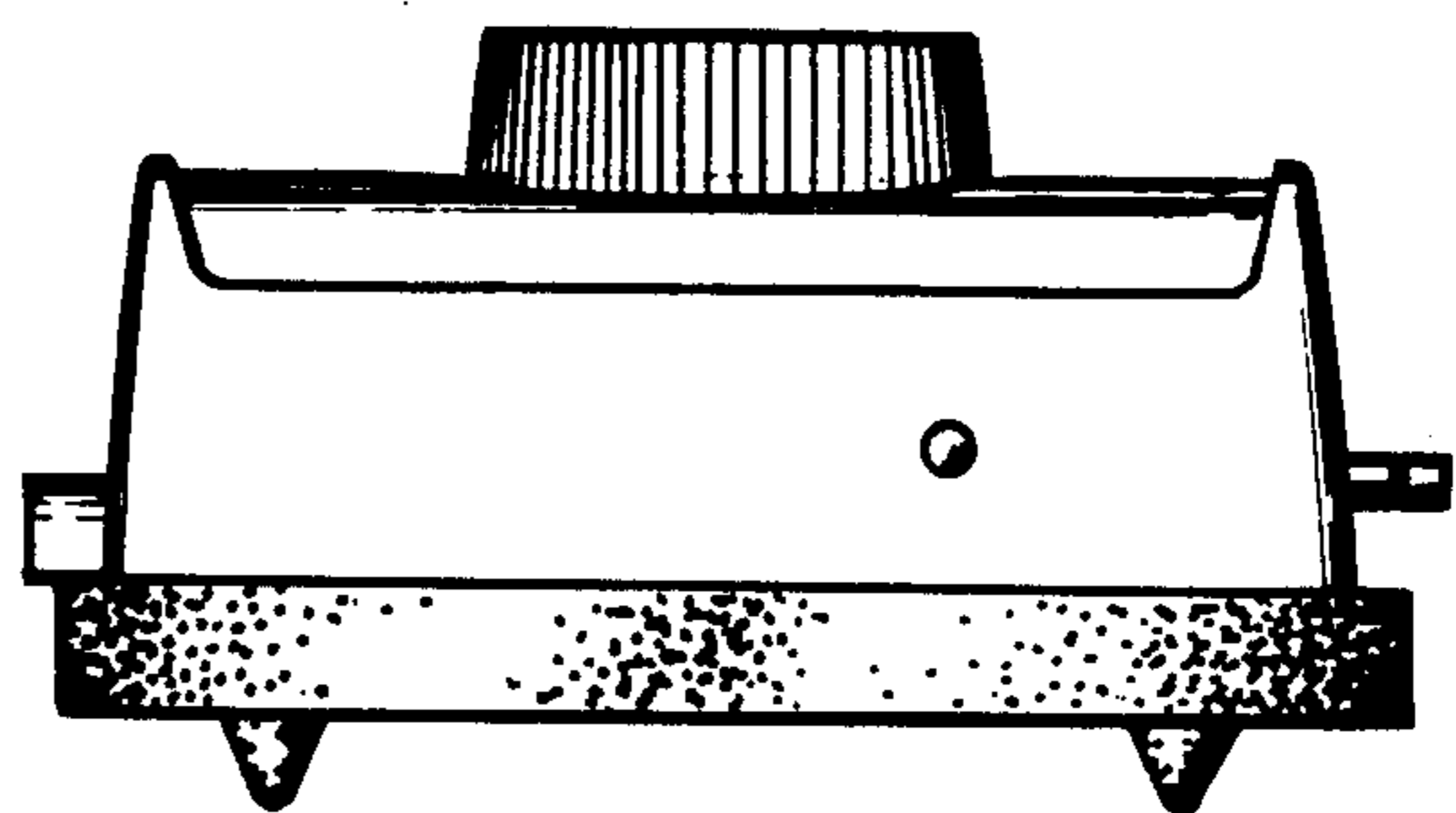

FIG. 10

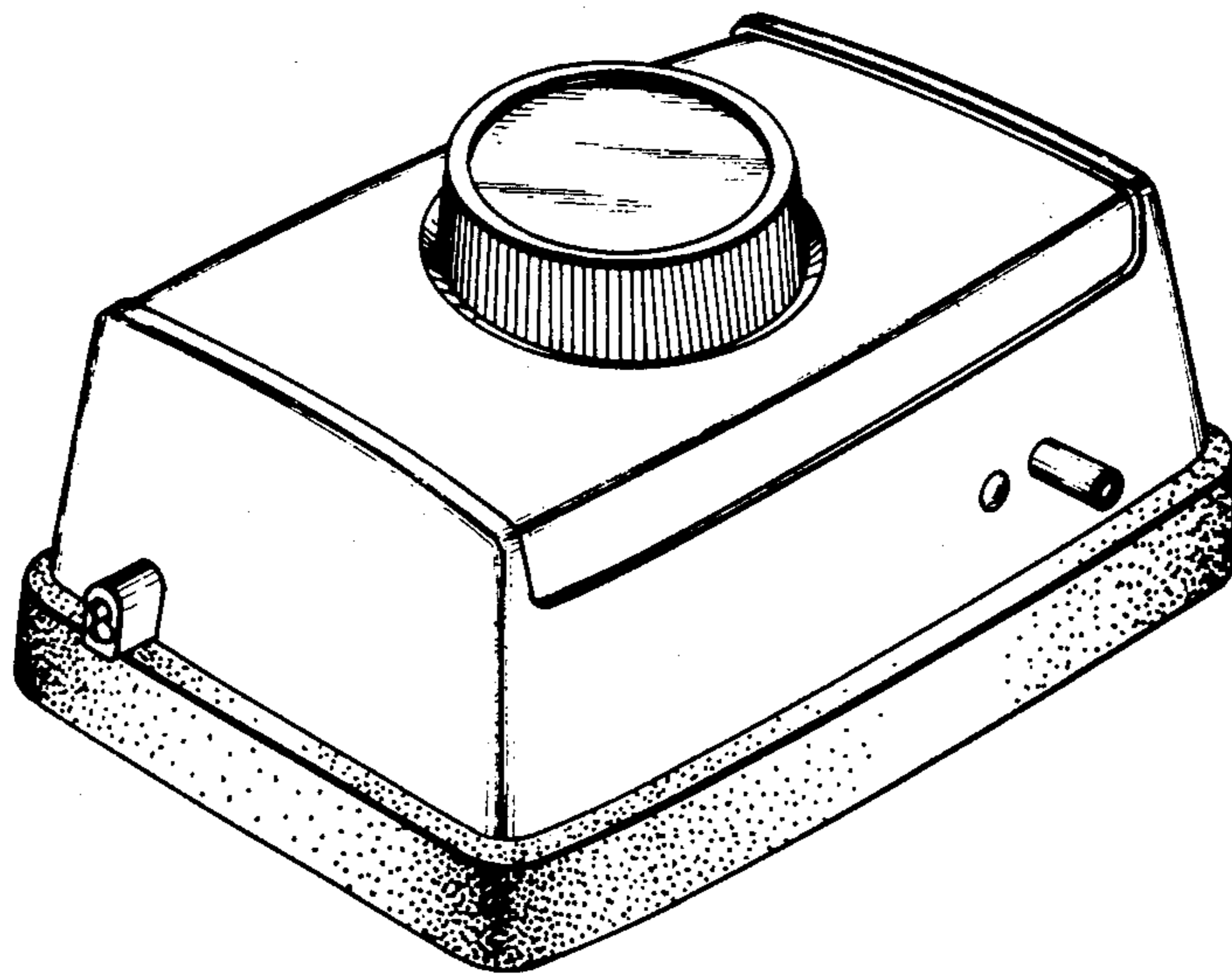

FIG. 11

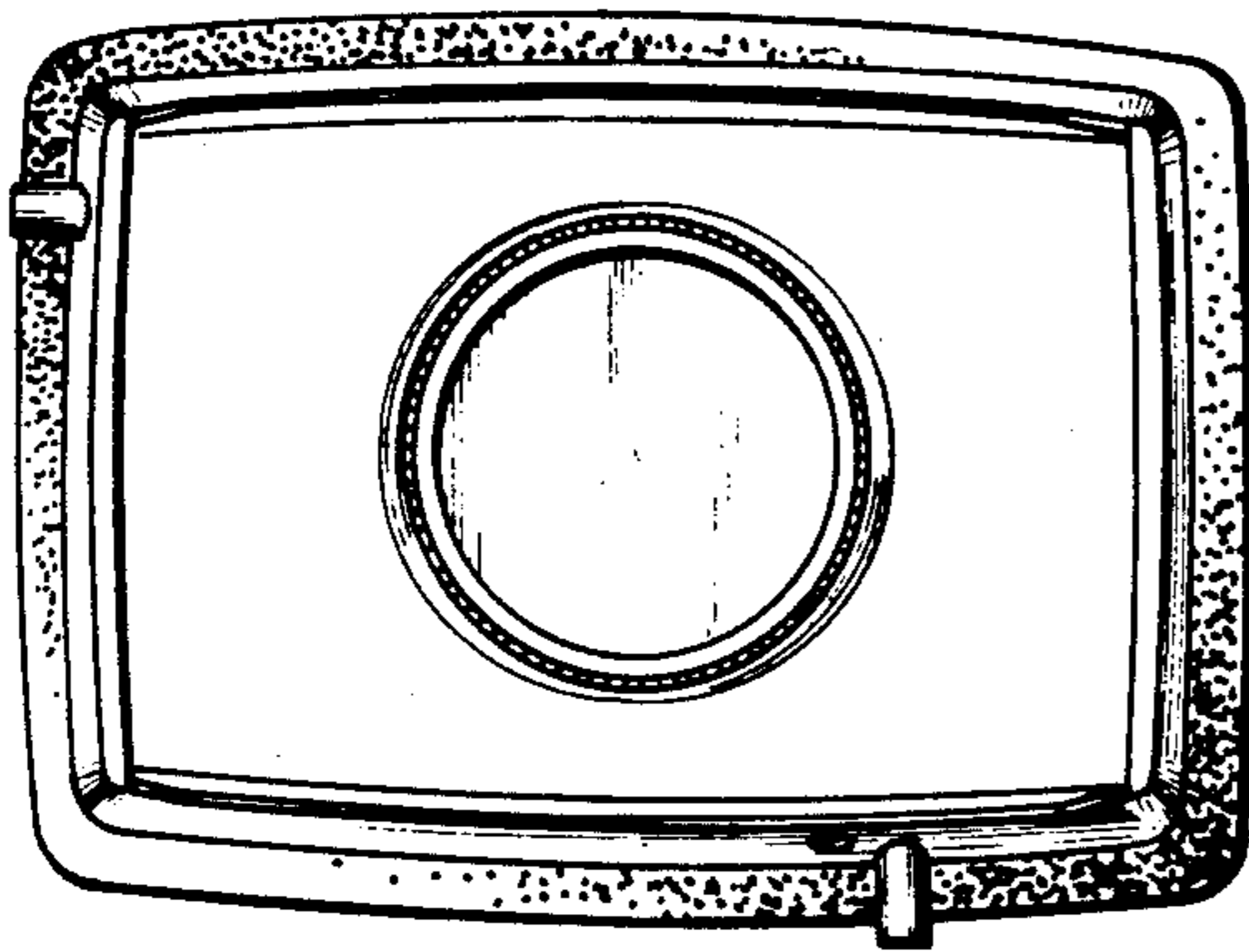

FIG. 12

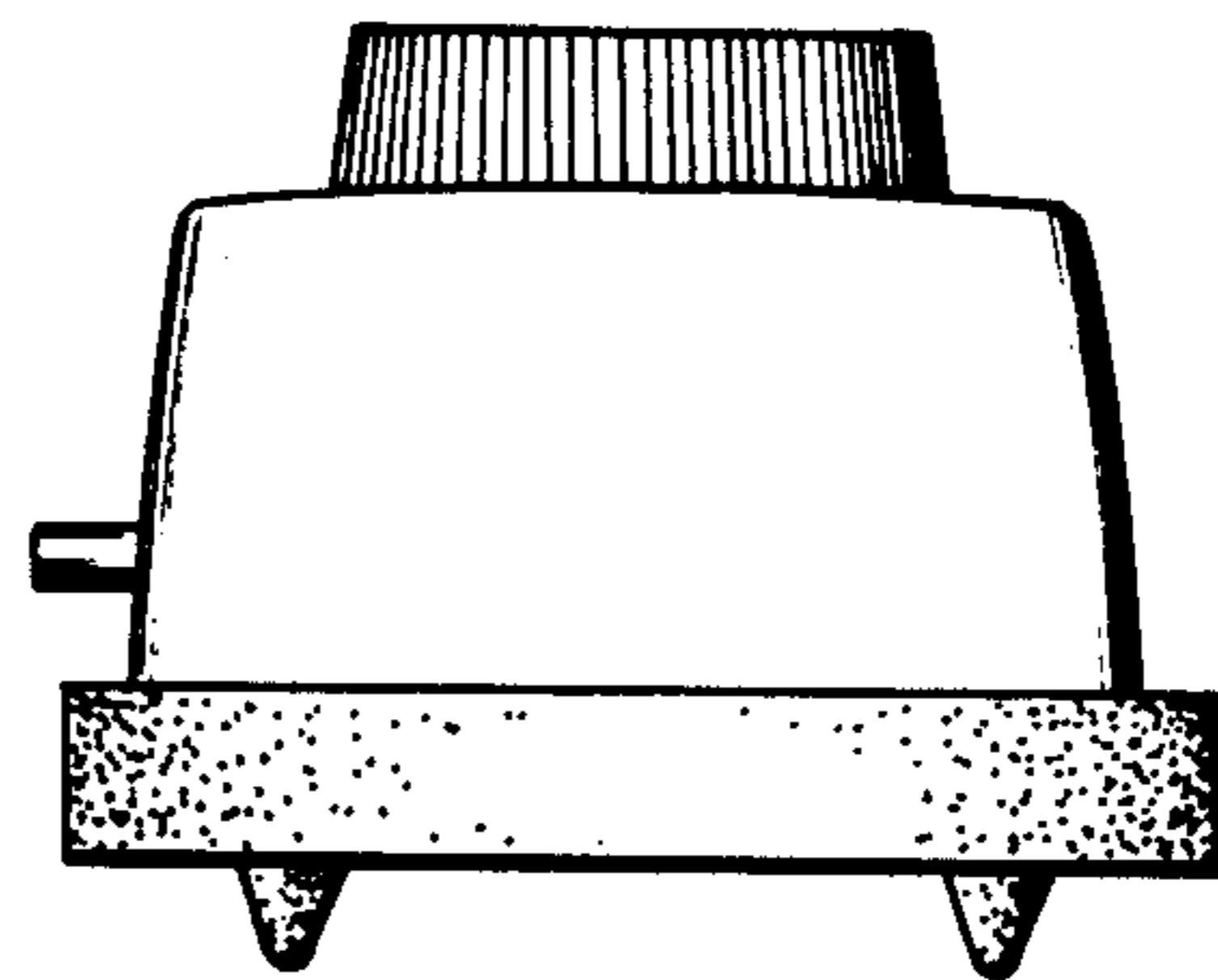

FIG. 14

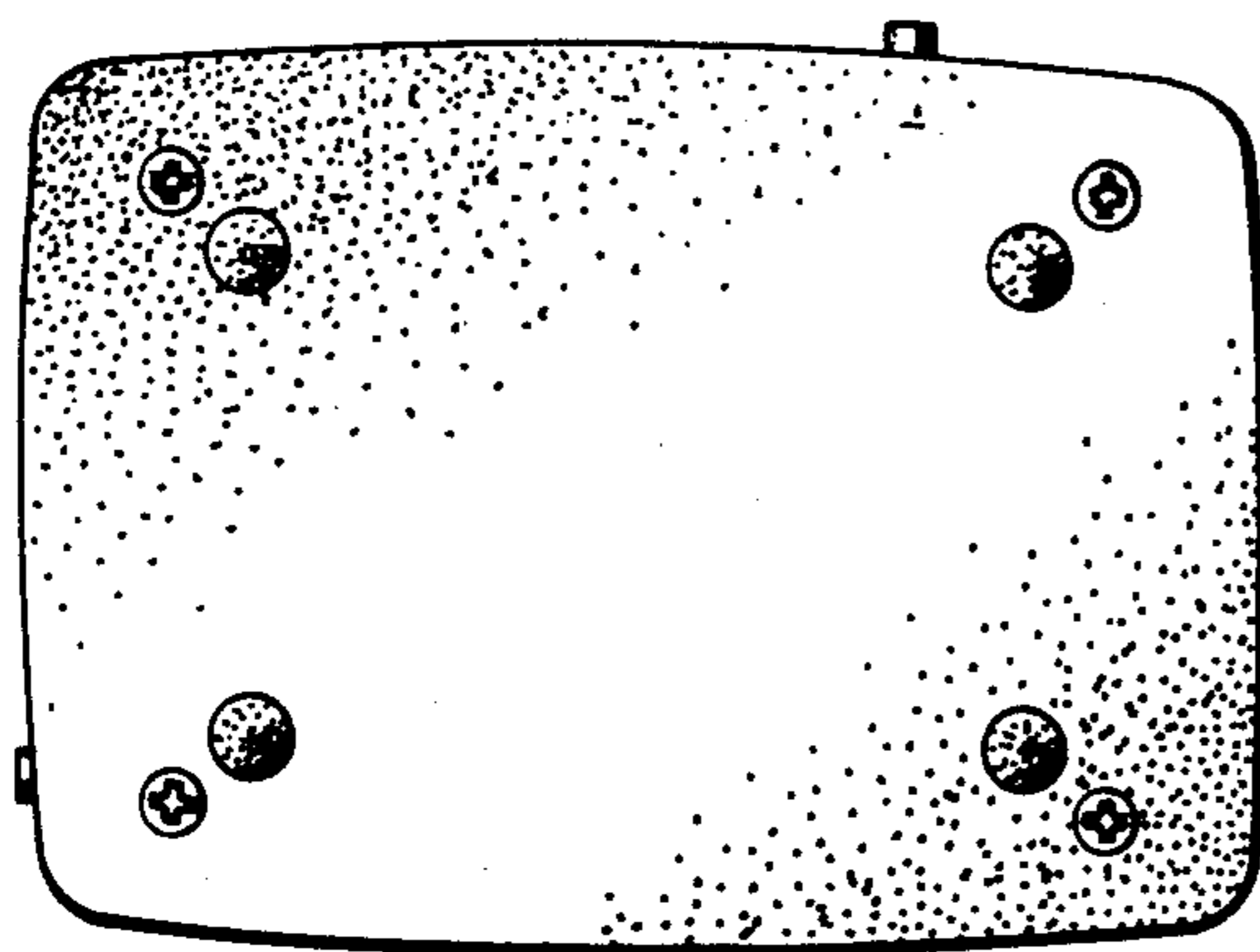

FIG. 13

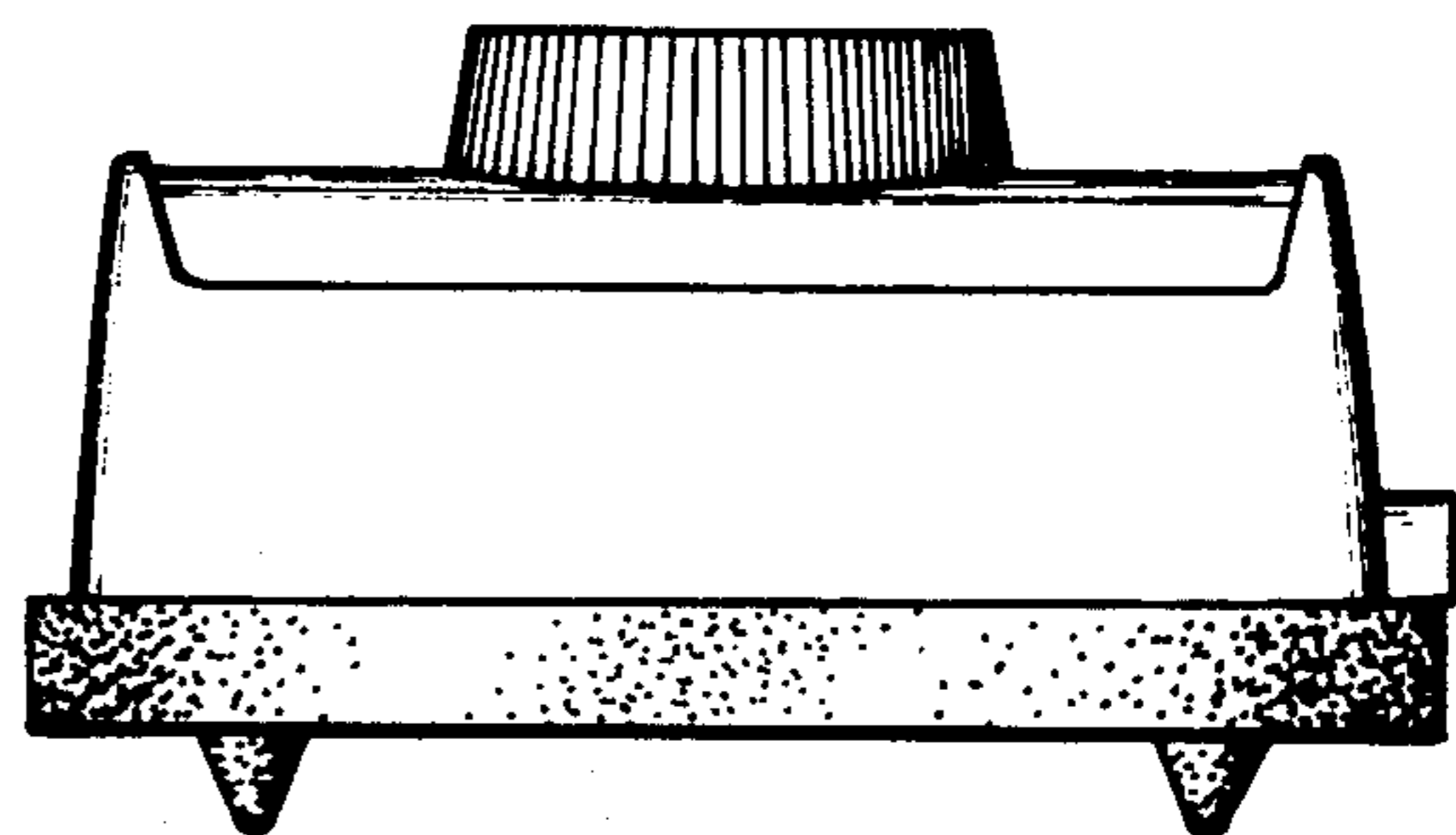

FIG. 15