

[54] PACKAGING CONTAINER FOR SHOES OR THE LIKE

1,975,128 10/1934 Sherman ..... D9/183 X  
3,977,595 8/1976 Hillgenberg ..... 229/29 M X

[76] Inventors: Juan Carlos Schidlowski, P.O. Box 14, Sedalia, Colo. 80135; Stephen F. Walker, 2722 S. Oakland Circle East, Denver, Colo. 80323

Primary Examiner—Robert C. Spangler  
Attorney, Agent, or Firm—Gary M. Polumbus

[\*\*] Term: 14 Years

[57] CLAIM

The ornamental design for a packaging container for shoes or the like, as shown.

[21] Appl. No.: 637,285

DESCRIPTION

[22] Filed: Dec. 3, 1975

FIG. 1 is a top, front perspective view of a packaging container for shoes or the like showing our new design; FIG. 2 is an end elevational view; FIG. 3 is a top plan view; FIG. 4 is a top plan view with the lid omitted; FIG. 5 is a front elevational view; FIG. 7 is a top perspective view with the lid in an open position; FIG. 8 is an enlarged fragmentary vertical section taken through the front closure portion; and FIG. 9 is an enlarged fragmentary vertical section taken through an end wall.

[51] Int. Cl. .... D9-03

[52] U.S. Cl. .... D9/183

[58] Field of Search ..... D9/182, 183, 187, 219, D9/230-235; 229/2.5, 15, 146, 29 M

[56] References Cited

U.S. PATENT DOCUMENTS

D. 240,353 6/1976 Edwards ..... D9/183  
D. 241,822 10/1976 Jewell ..... D9/182 X

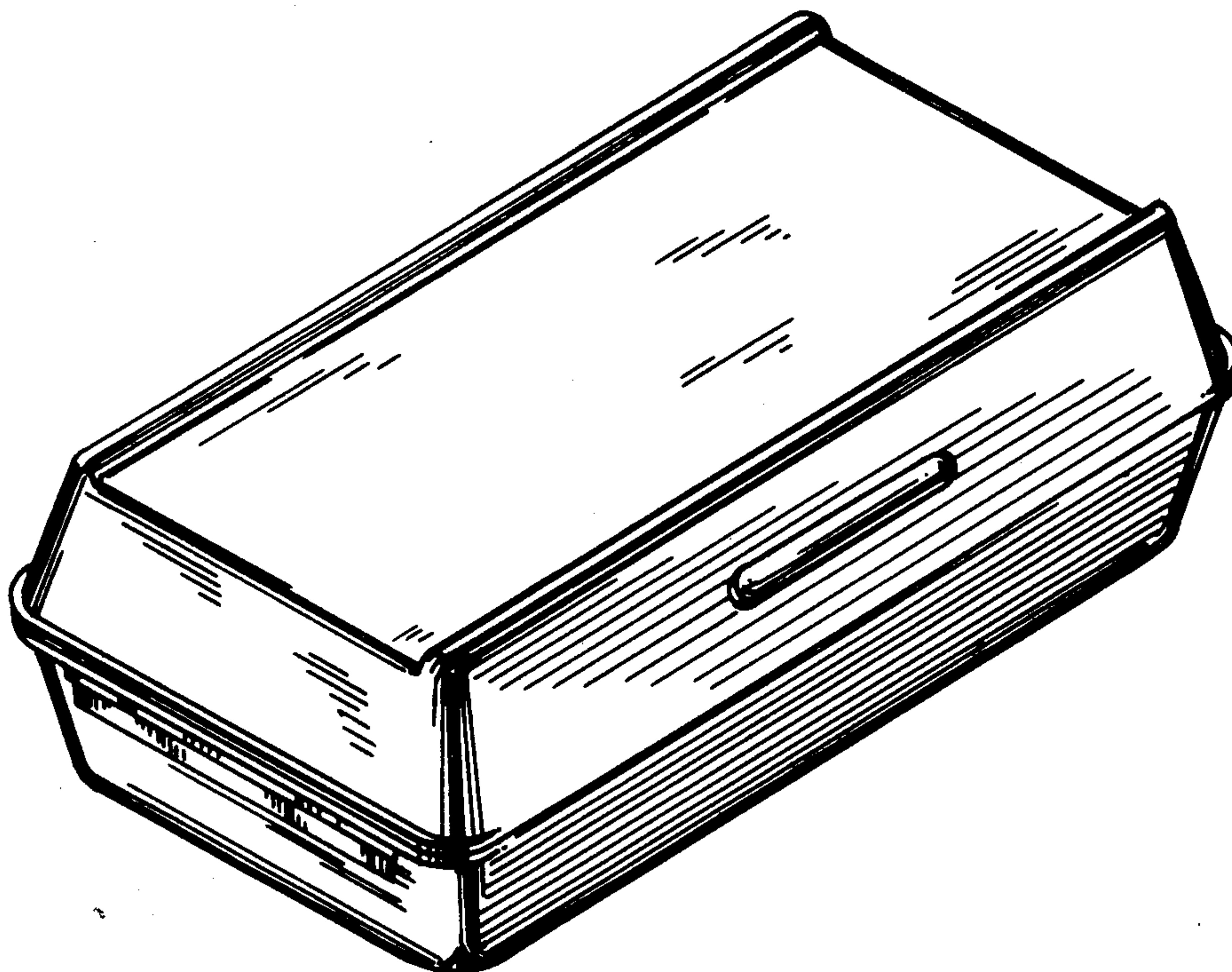

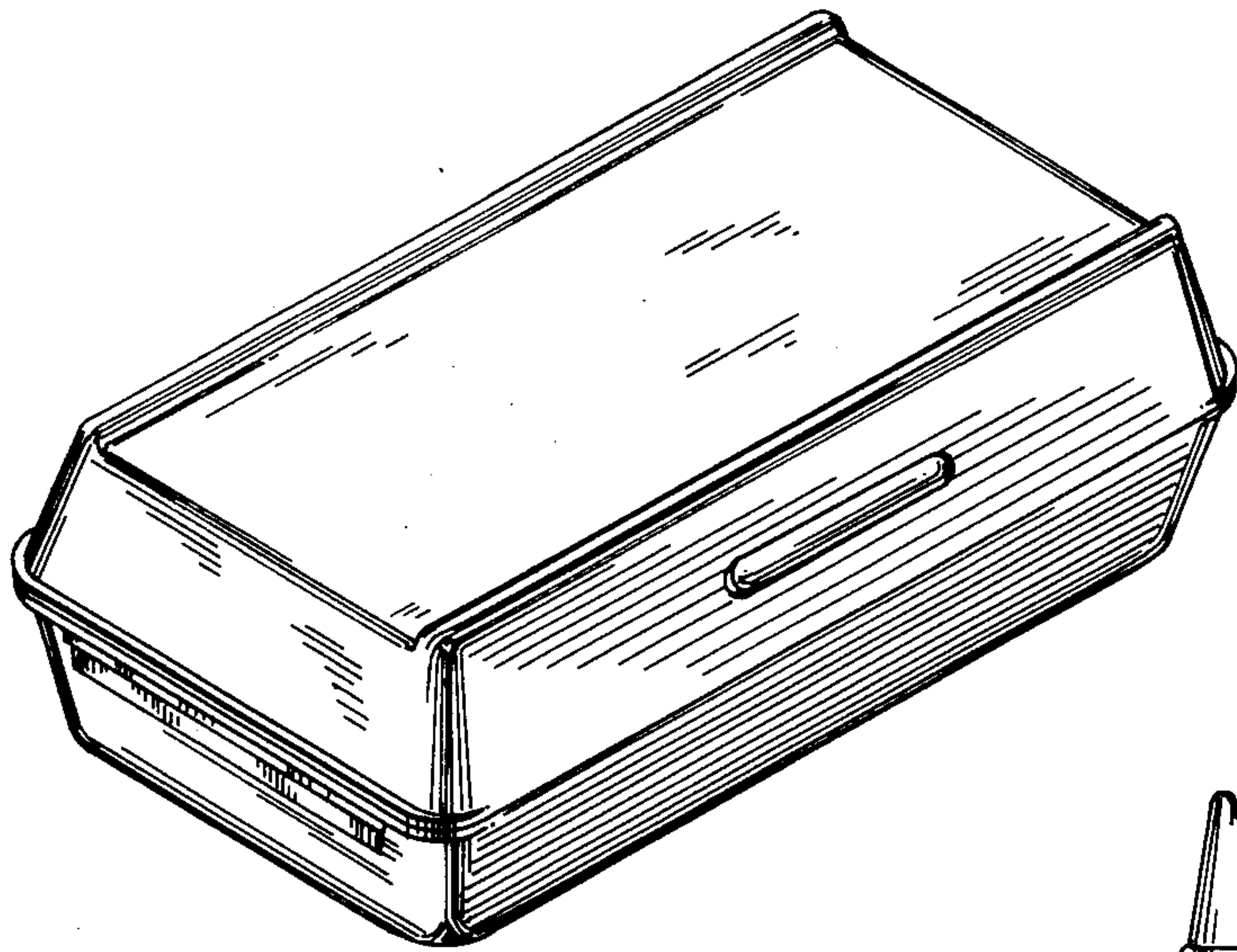

*Fig\_1*

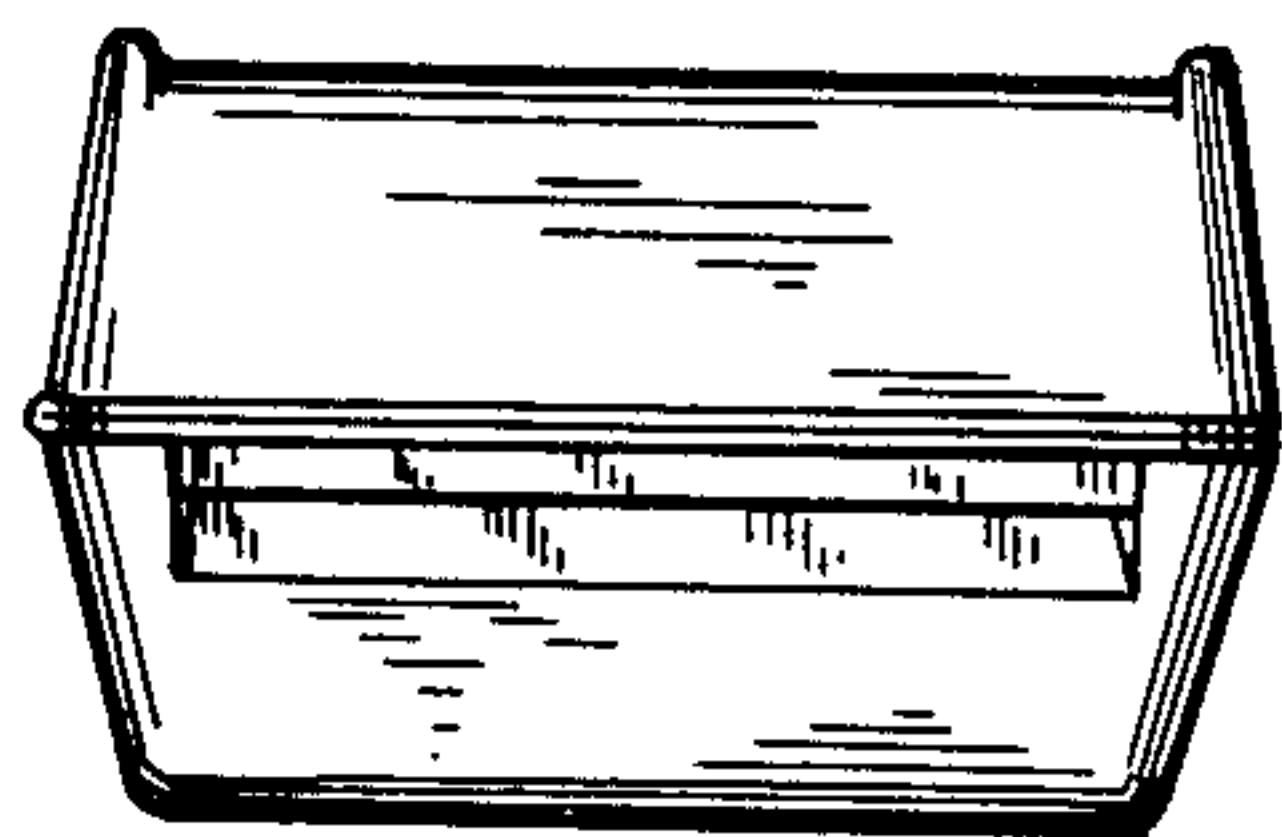

*Fig\_2*

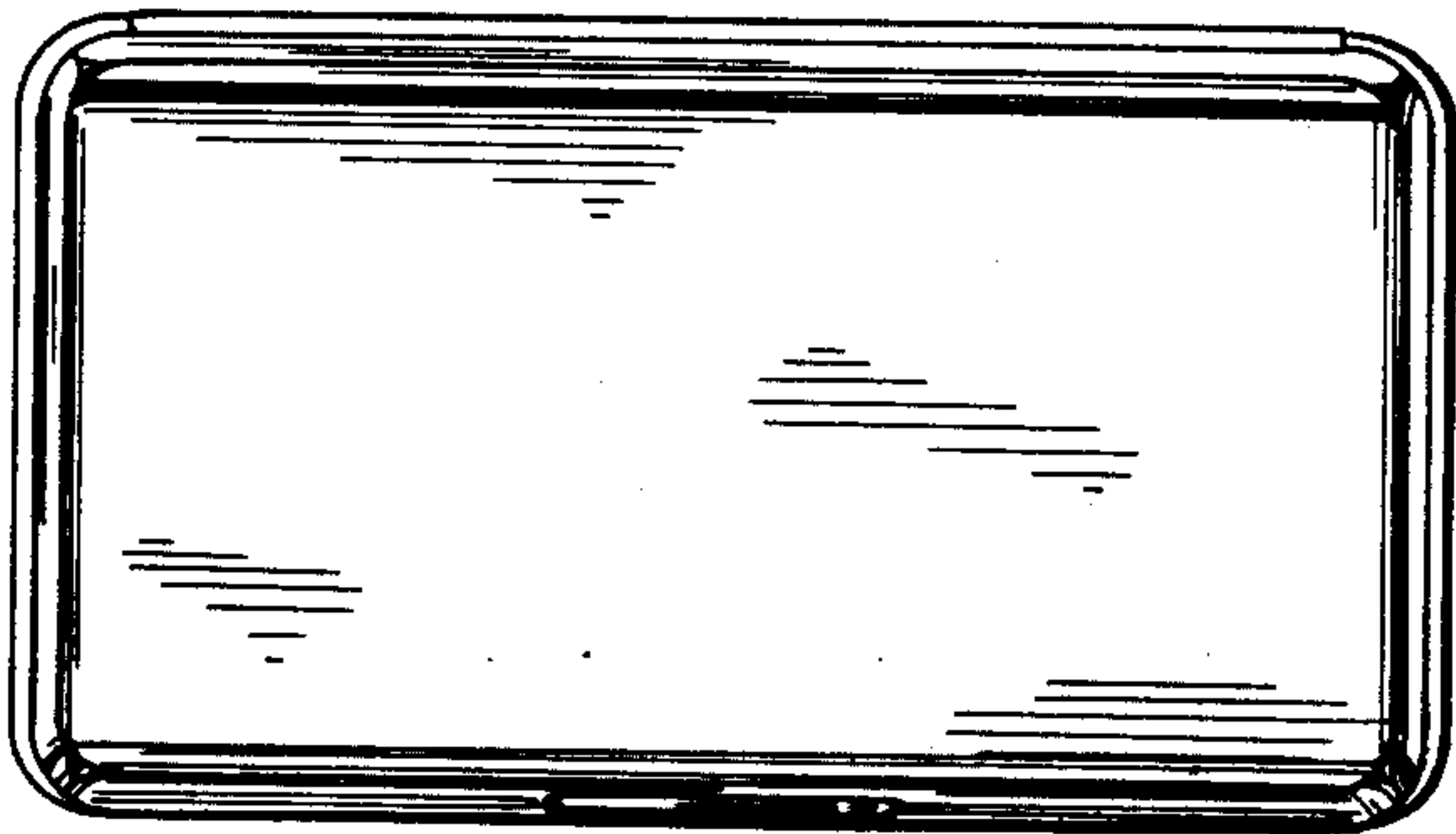

*Fig\_3*

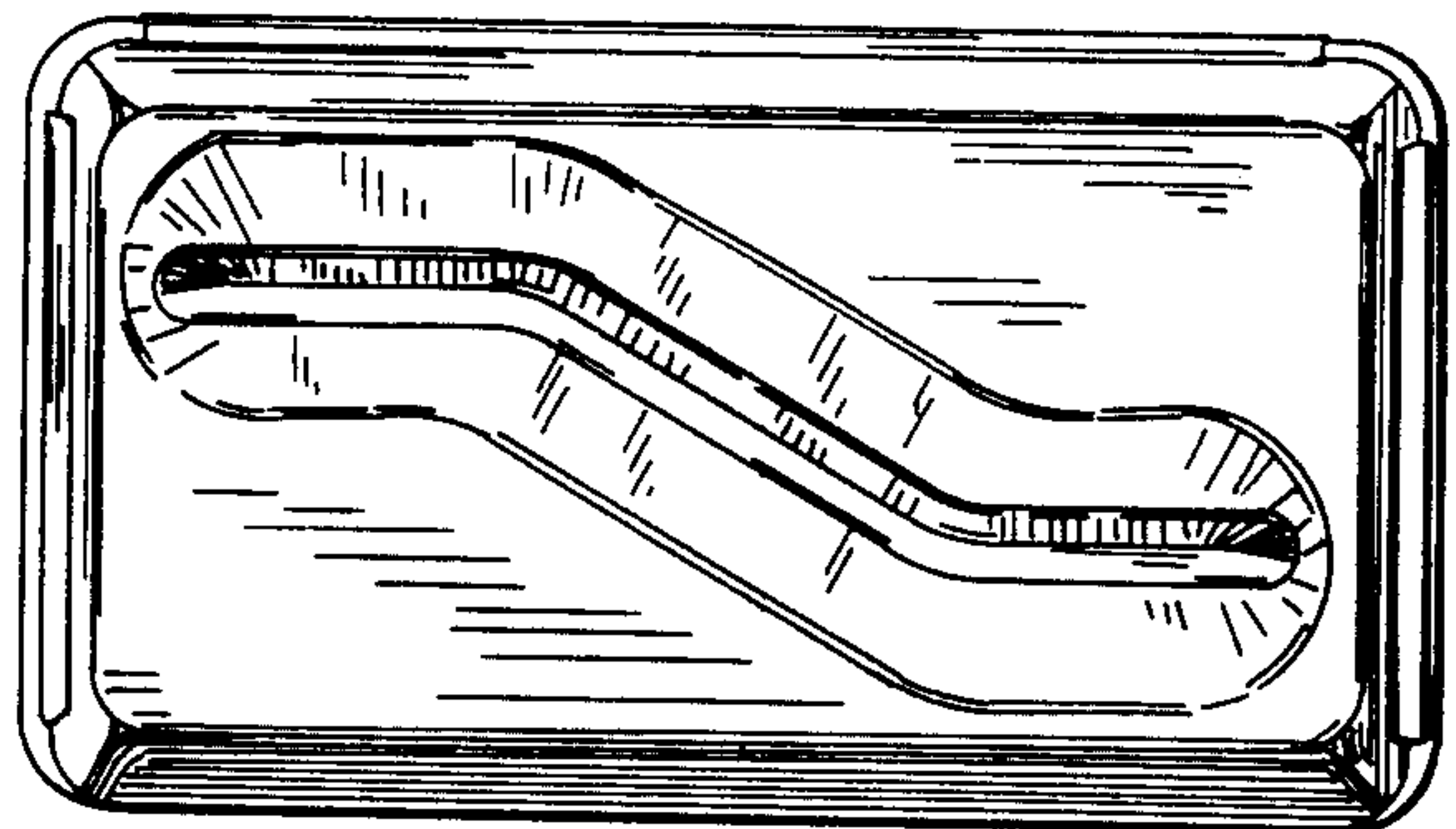

*Fig\_4*

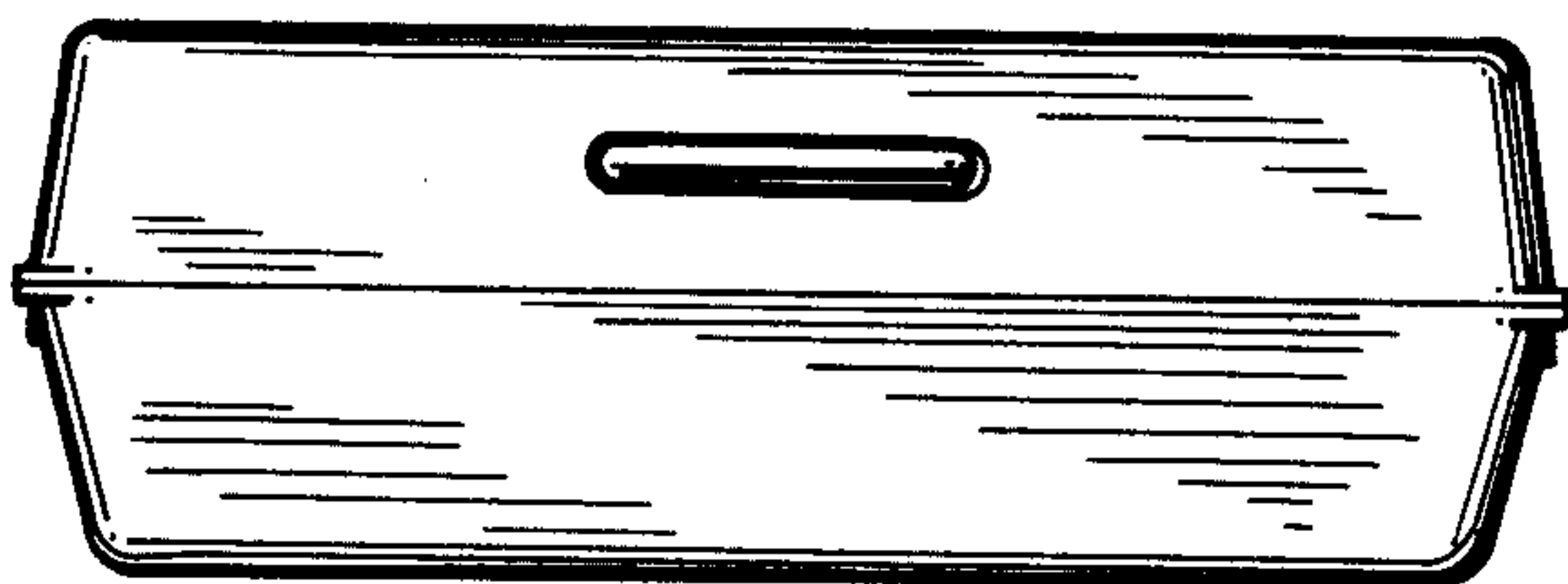

*Fig\_5*

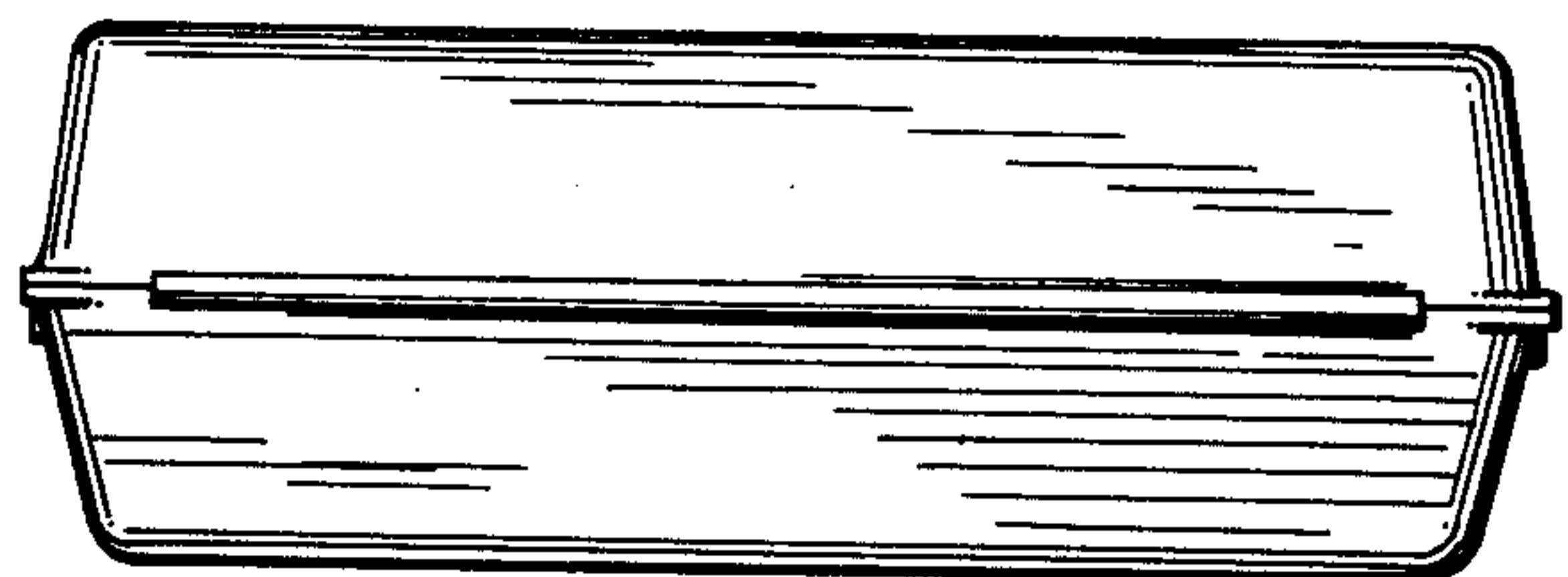

*Fig\_6*



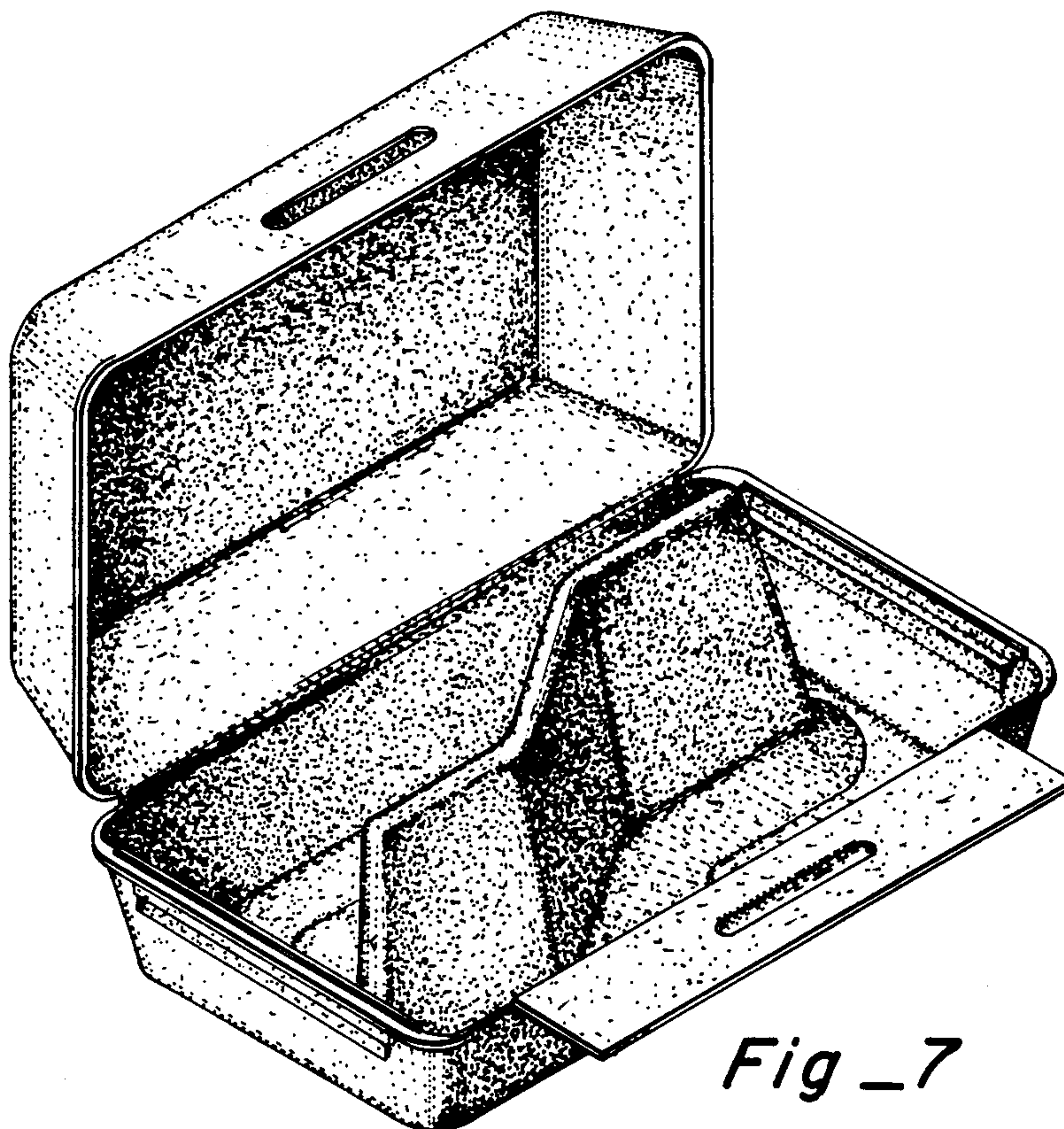

*Fig\_7*

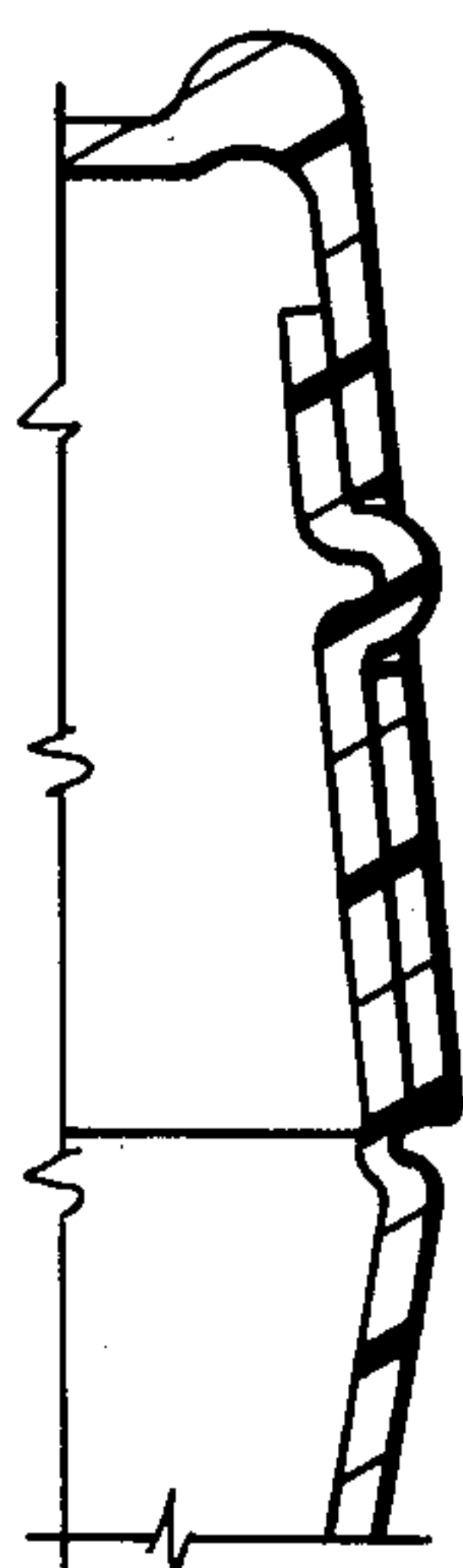

*Fig\_8*

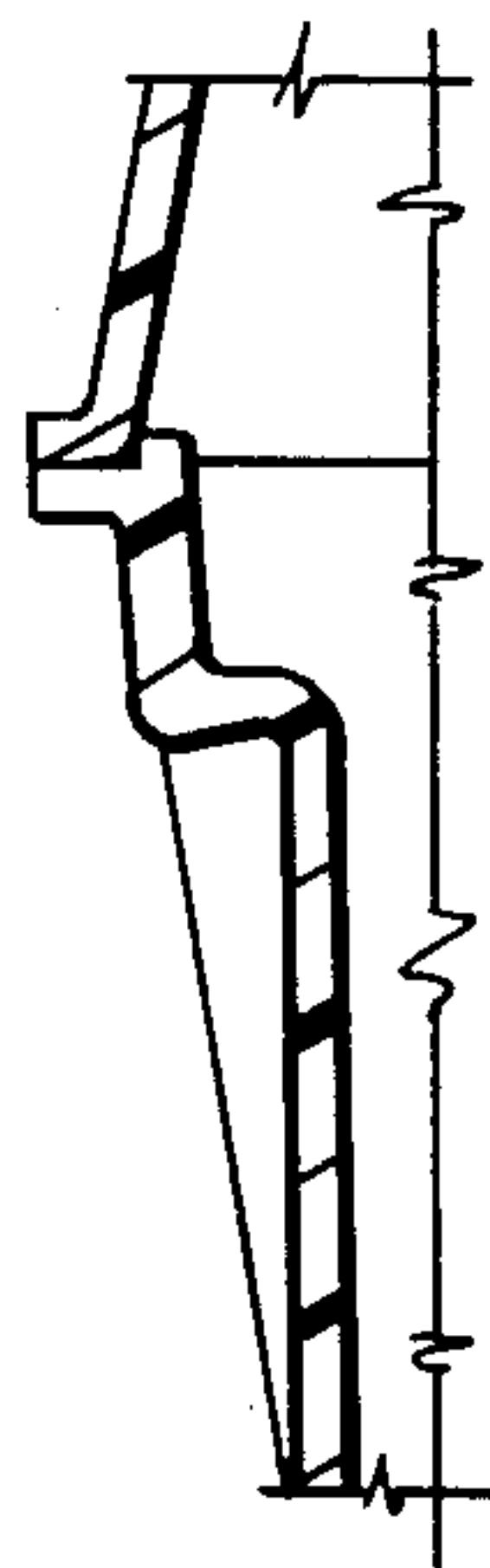

*Fig\_9*