

[54] HEATING STOVE

[75] Inventor: George Paul Bader, LaFarge, Wis.

[73] Assignee: Kickapoo Stove Works, Ltd., LaFarge, Wis.

[**] Term: 14 Years

[21] Appl. No.: 652,550

[22] Filed: Jan. 26, 1976

[51] Int. Cl. D23-03

[52] U.S. Cl. D23/93

[58] Field of Search D23/97, 94, 93, 92, D23/105, 107; 126/58, 59, 60, 61, 62, 63, 65, 66

[56] References Cited

U.S. PATENT DOCUMENTS

D. 236,346 8/1975 Kemple D23/93

| | | | |
|------------|--------|------------------|----------|
| D. 238,949 | 2/1976 | Giovagnoli | D23/93 |
| D. 239,949 | 2/1976 | Giovagnoli | D23/97 |
| 398,862 | 3/1889 | Stott | 126/61 |
| 567,034 | 9/1896 | Loy | 126/61 |
| 3,654,912 | 4/1972 | Albright | 126/41 R |

Primary Examiner—Alan P. Douglas
Attorney, Agent, or Firm—John Clarke Holman

[57] CLAIM

The ornamental design for a heating stove, as shown.

DESCRIPTION

FIG. 1 is a perspective view of a heating stove showing the new design;

FIG. 2 is a front view of the heating stove;

FIG. 3 is a left side view of the heating stove;

FIG. 4 is a right side view of the heating stove;

FIG. 5 is a rear view of the heating stove;

FIG. 6 is a top view of the heating stove; and

FIG. 7 is a bottom view of the heating stove.

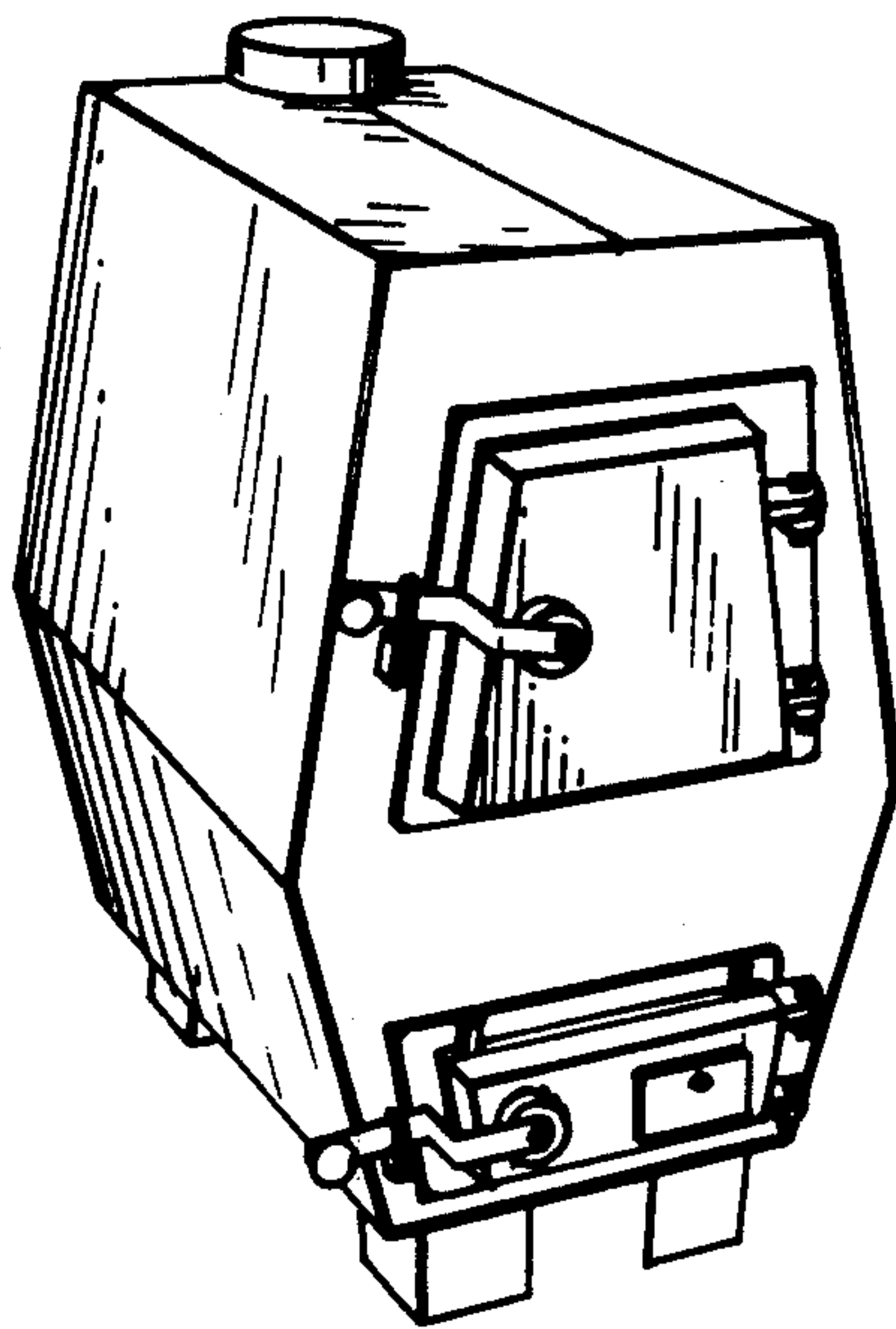

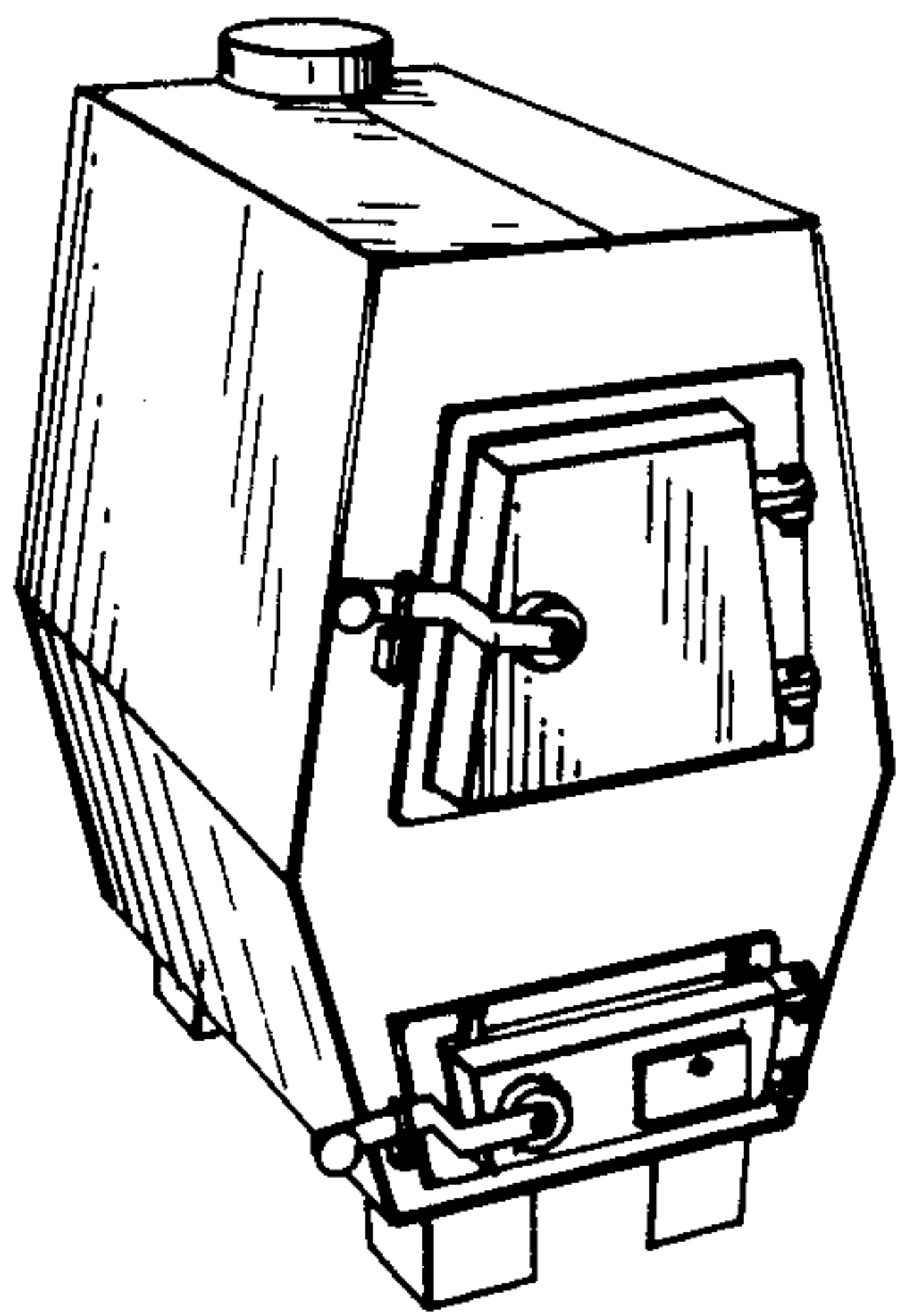

FIG. 1

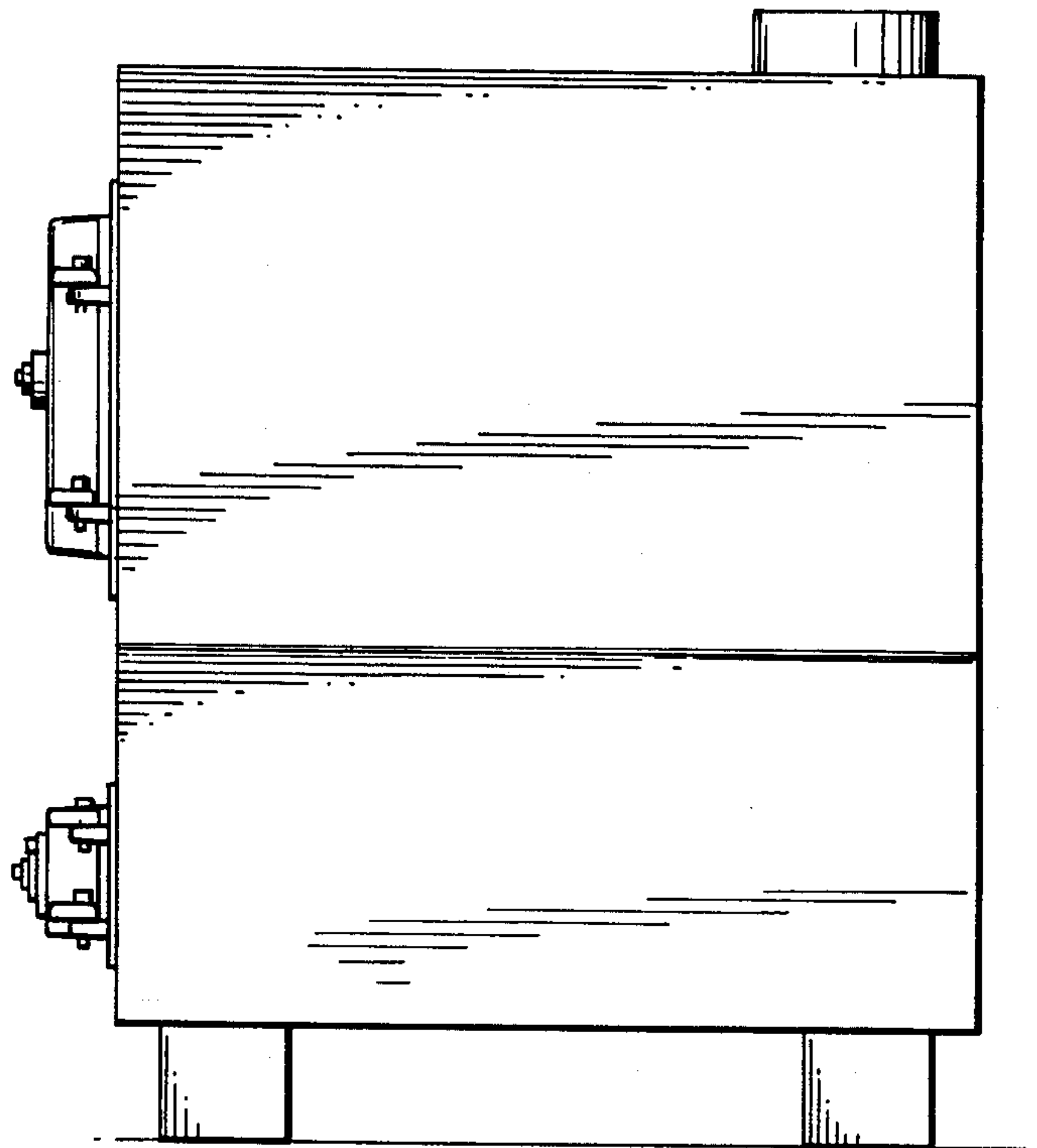

FIG. 3

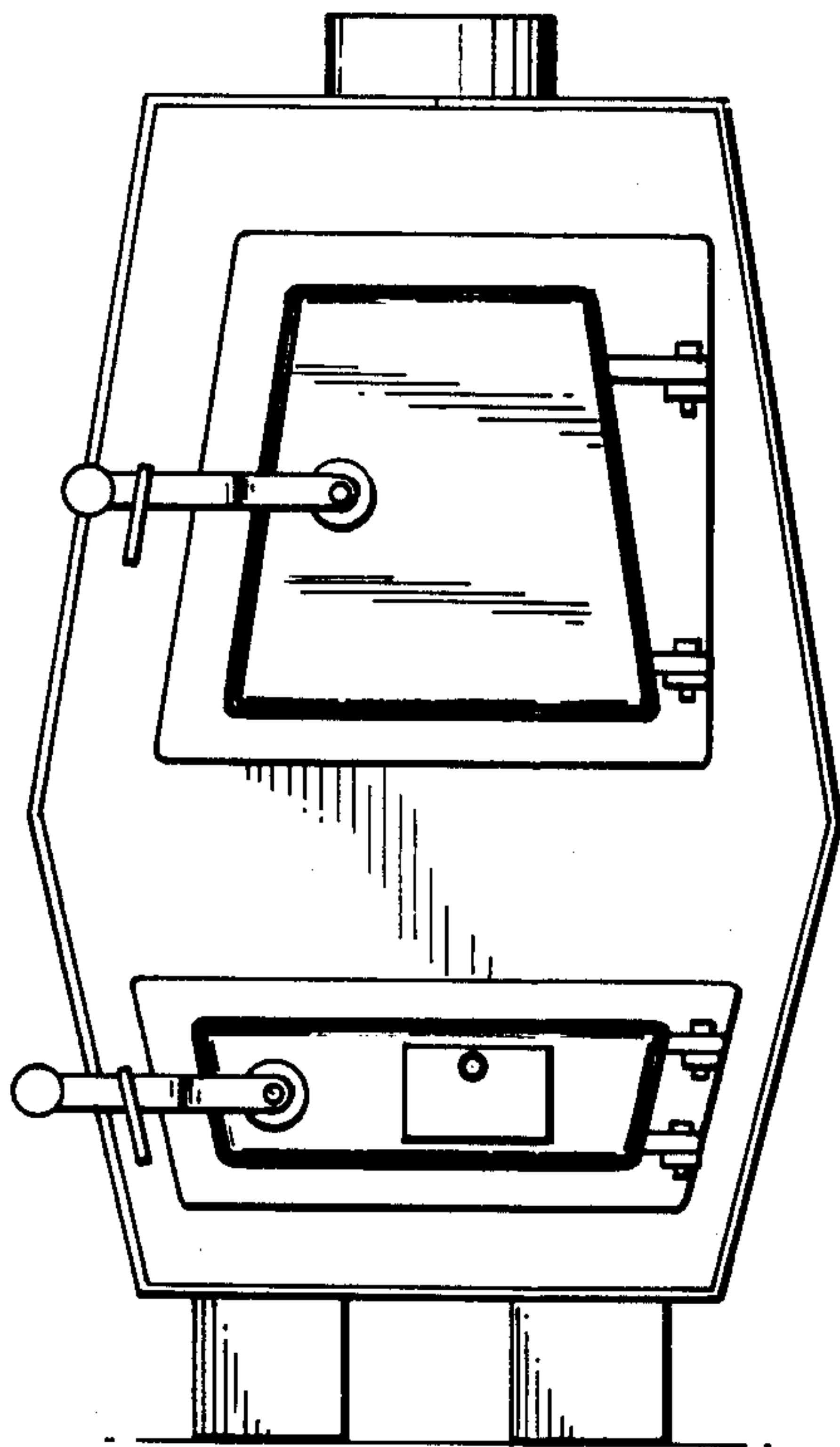

FIG. 2

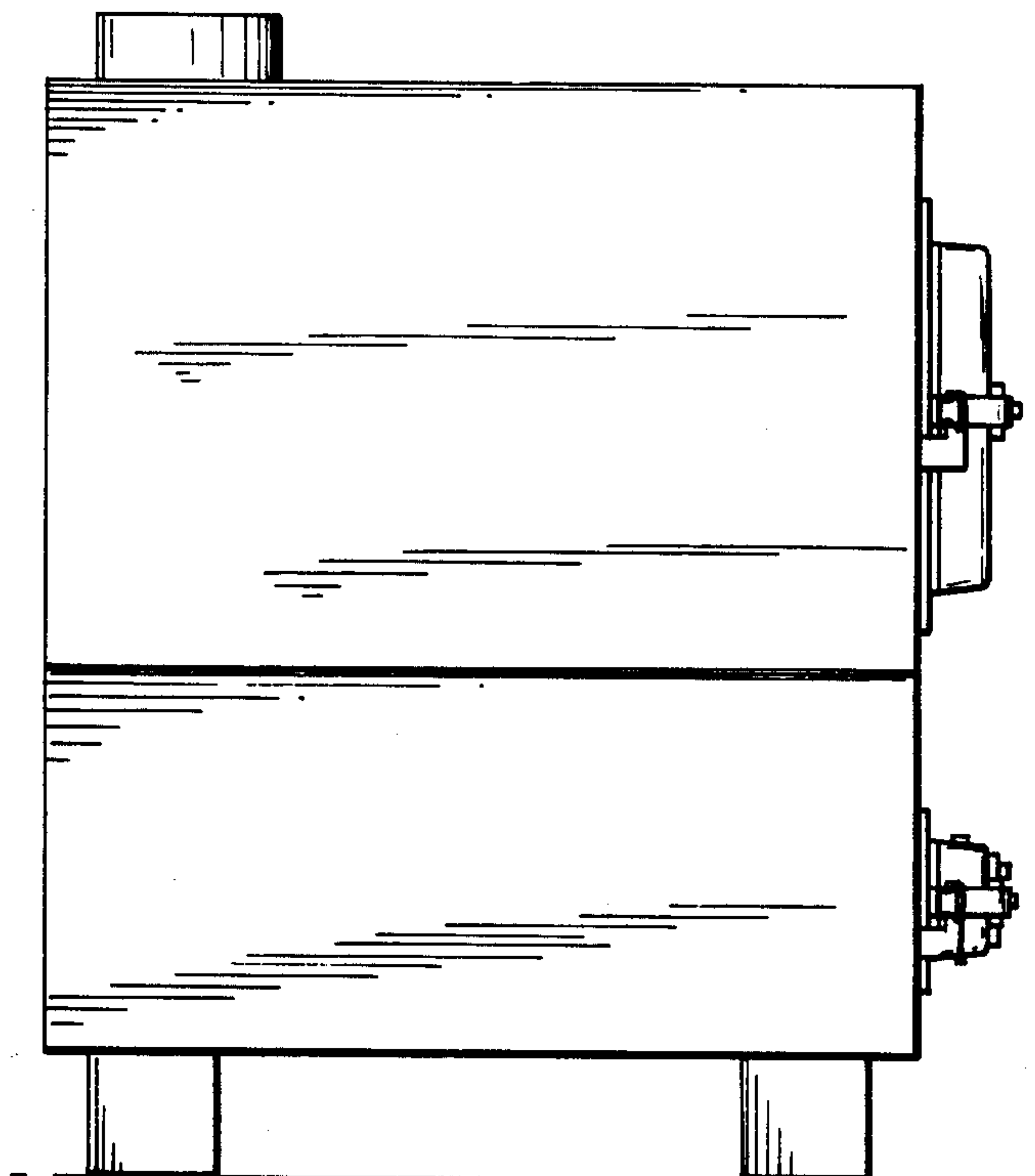

FIG. 4

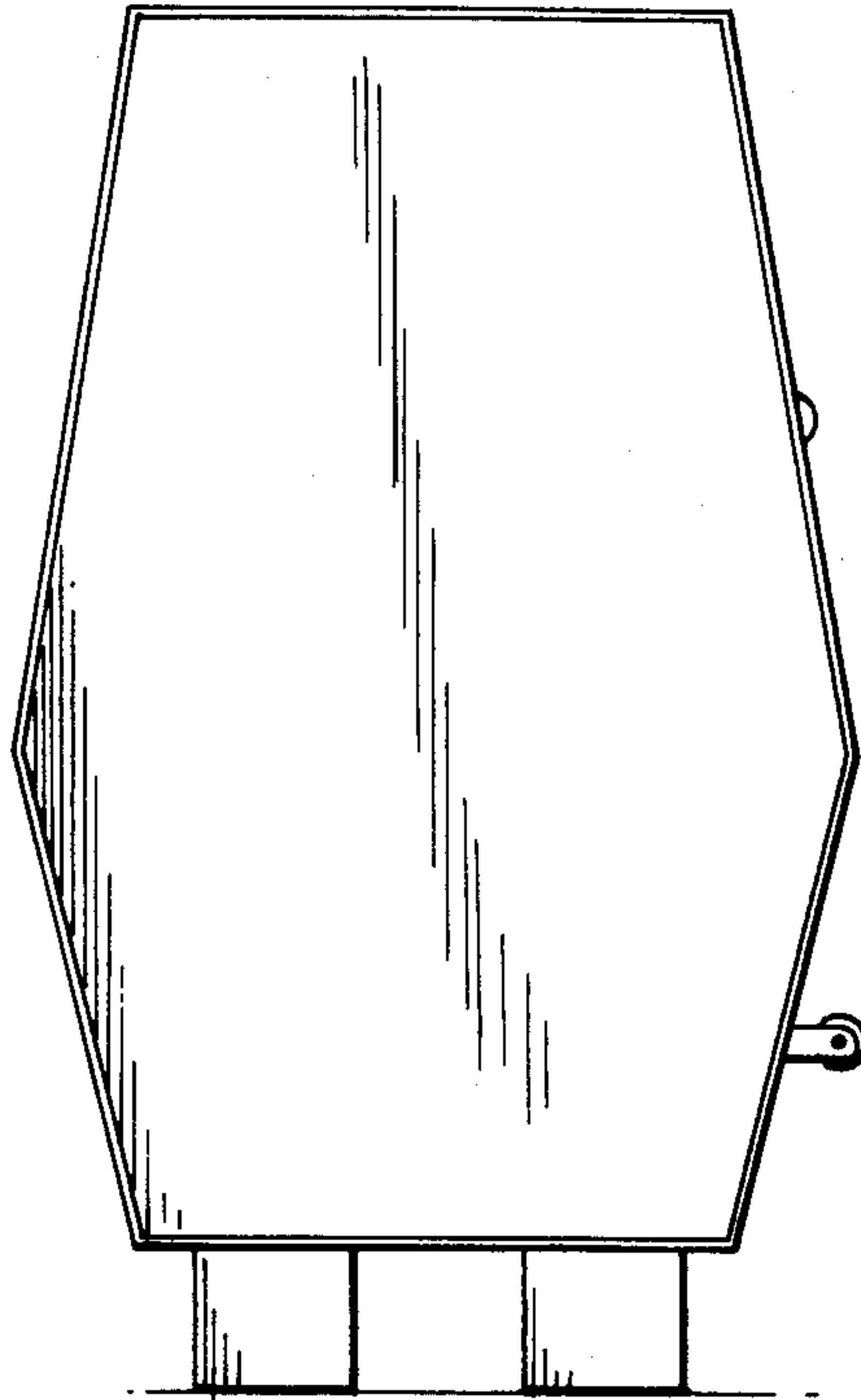

FIG. 5

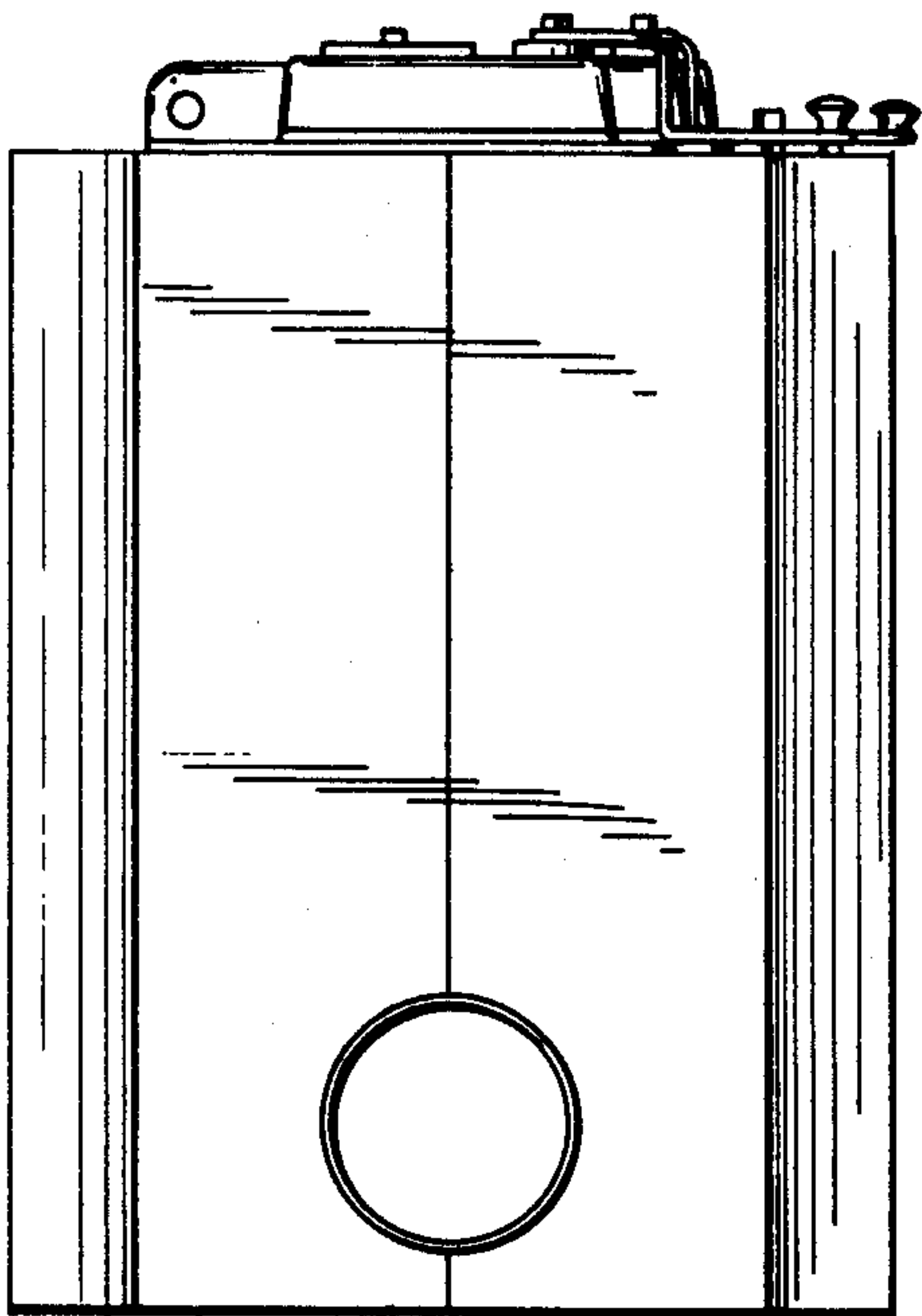

FIG. 6

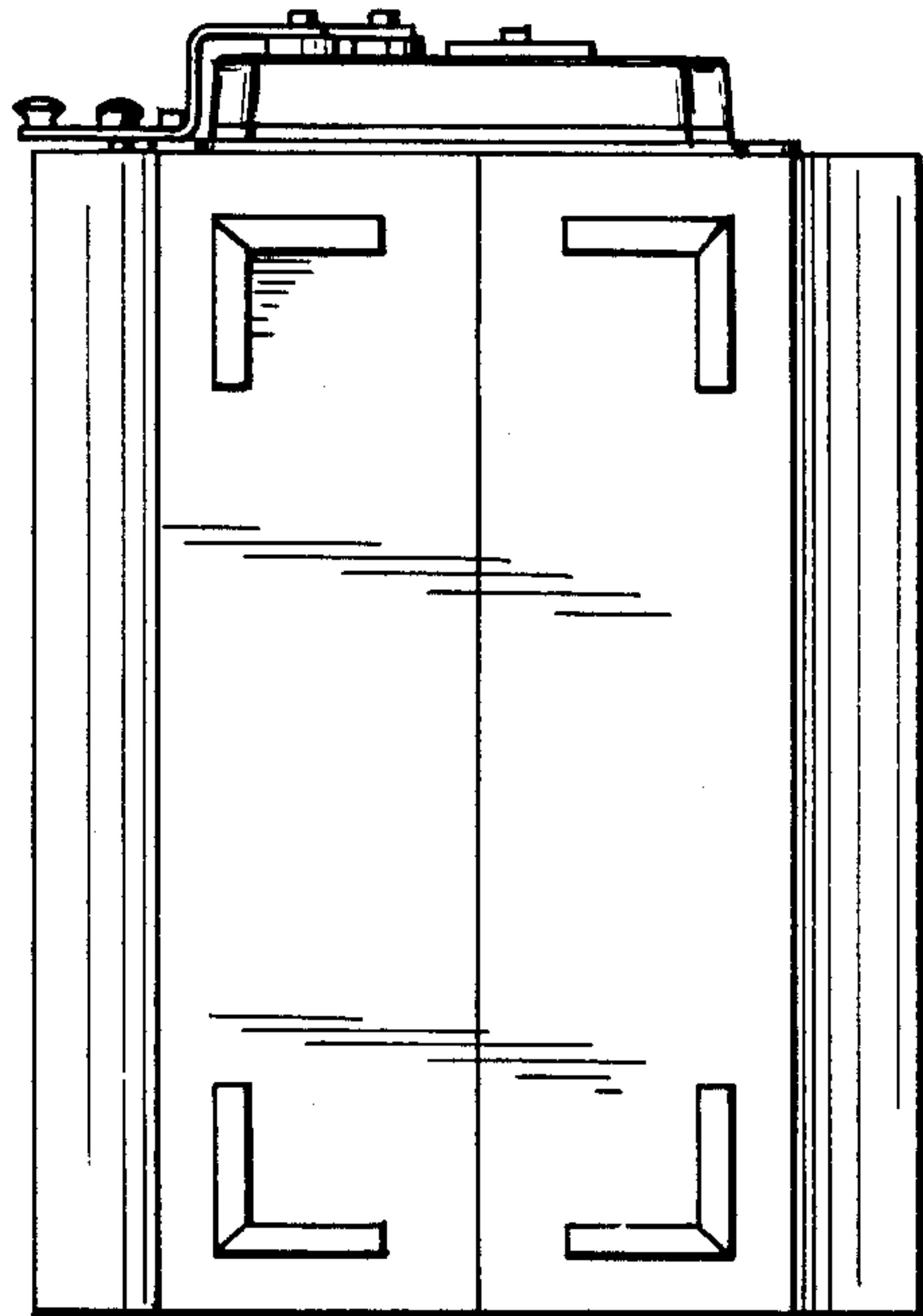

FIG. 7