

[54] HAIR STYLER ATTACHMENT

[75] Inventors: Morison S. Cousins, Plainview; Michael A. Cousins, Huntington, both of N.Y.; Greydon A. Rhodes, III, Noroton, Conn.

[73] Assignee: The Gillette Company, Boston, Mass.

[**] Term: 14 Years

[21] Appl. No.: 660,620

[22] Filed: Feb. 23, 1976

[51] Int. Cl. D28-03

[52] U.S. Cl. D28/18

[58] Field of Search D86/10 A, 10 F, 8; 34/96-98, 101; 132/7, 9, 11 R, 11 A, 118, 126, 142, 148, 160, 161, DIG. 1

[56] References Cited

U.S. PATENT DOCUMENTS

1,040,711 8/1912 Longden 132/161 X
3,491,777 1/1970 Grosbard 132/120

FOREIGN PATENT DOCUMENTS

1,298,481 6/1962 France 132/142

OTHER PUBLICATIONS

Mademoiselle Nov. 1971, p. 49-Comb Dryer Attachment at bottom right.

Advertising Supplement to Washington Post Sunday 5/4/1975, p. 38-Sears Dryer Comb Attachments (item C).

Primary Examiner—Joel Stearman
Assistant Examiner—Louis S. Zarfes
Attorney, Agent, or Firm—Richard A. Wise

[57] CLAIM

The ornamental design for a hair styler attachment, as shown.

DESCRIPTION

FIG. 1 is a front elevational view of a hair styler attachment showing our new design; FIG. 2 is a right end elevational view; FIG. 3 is a left end elevational view; FIG. 4 is a bottom plan view; FIG. 5 is a top plan view; and FIG. 6 is a perspective view.

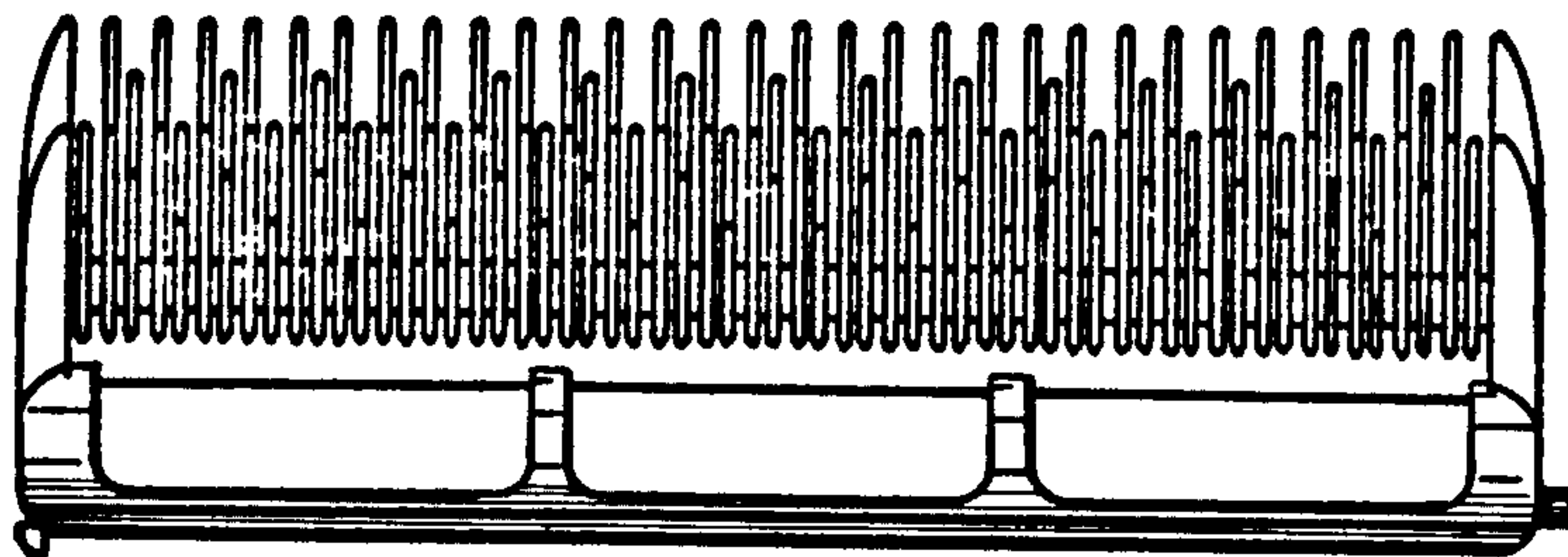

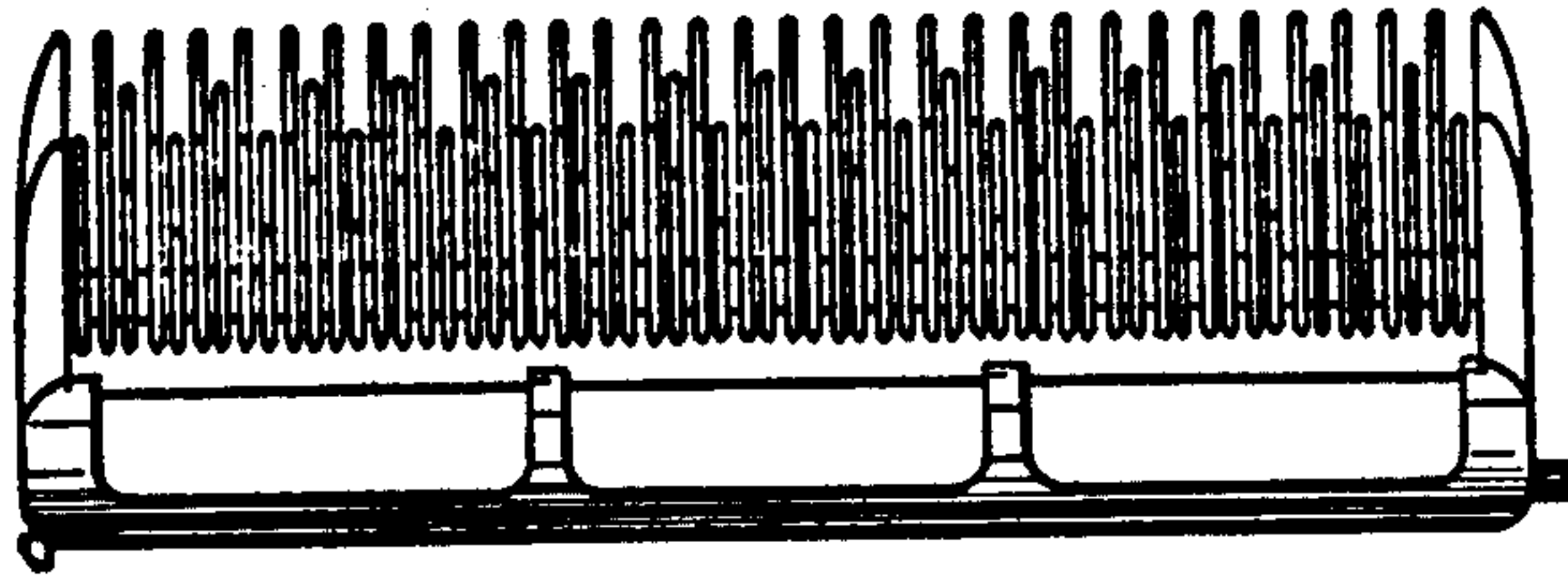

FIG. 1

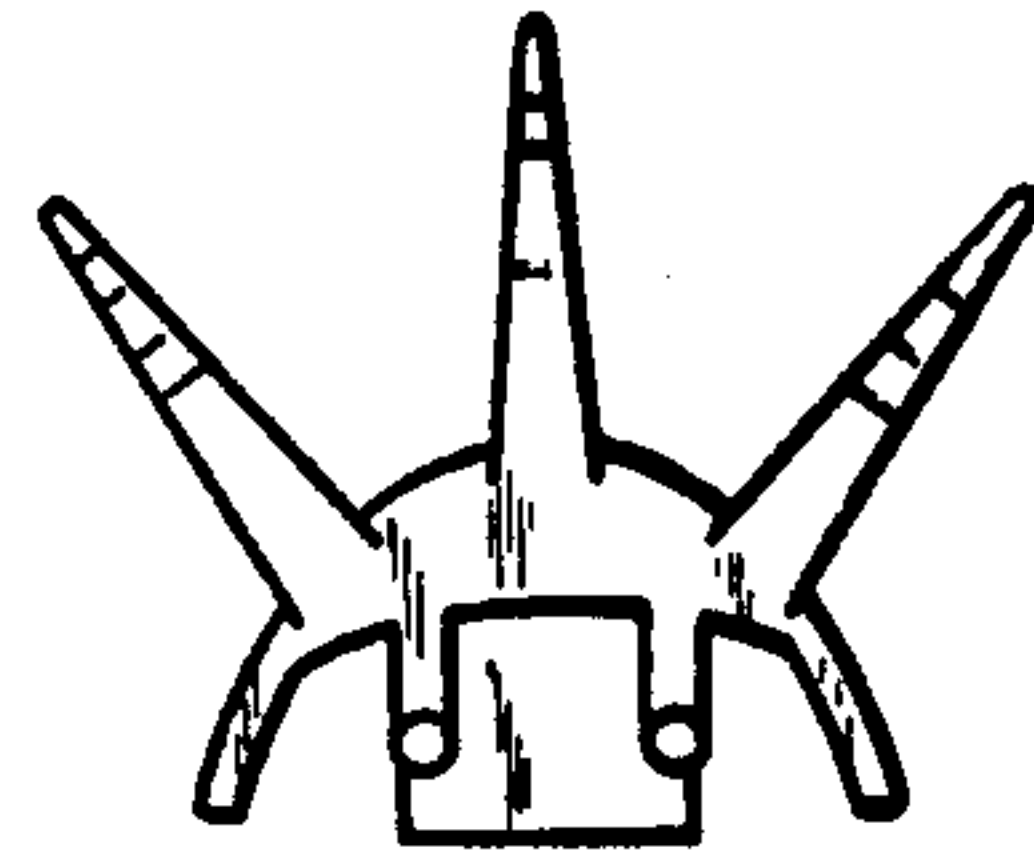

FIG. 2

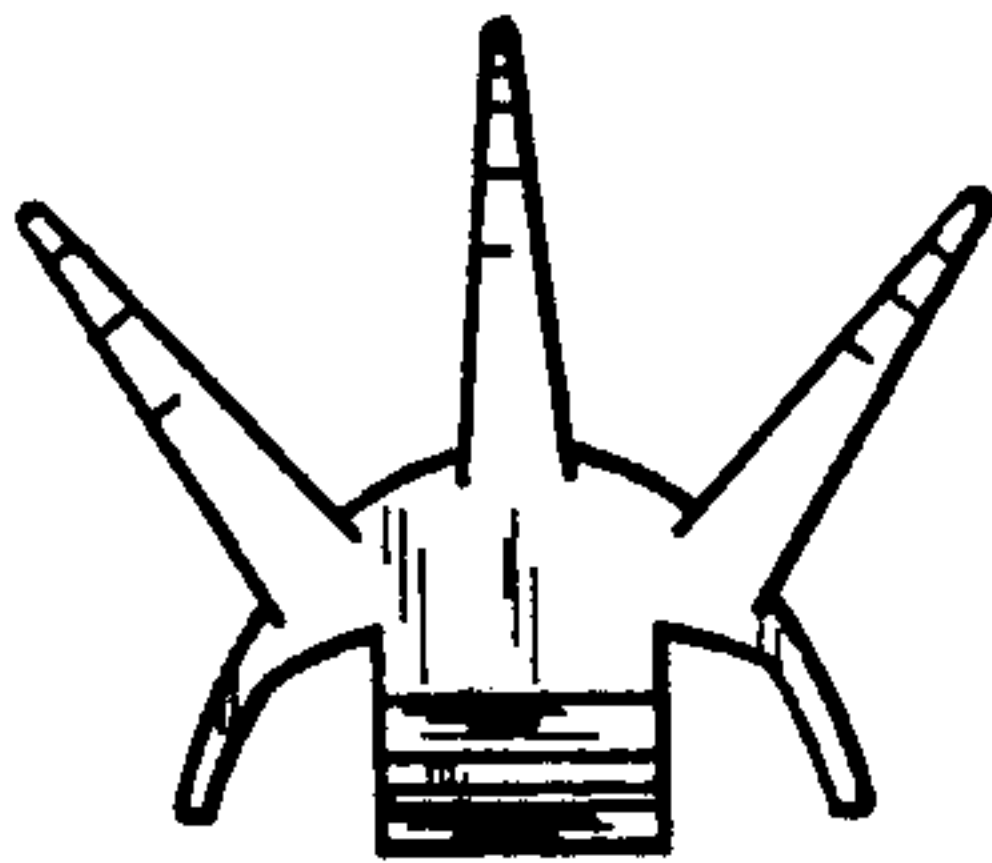

FIG. 3

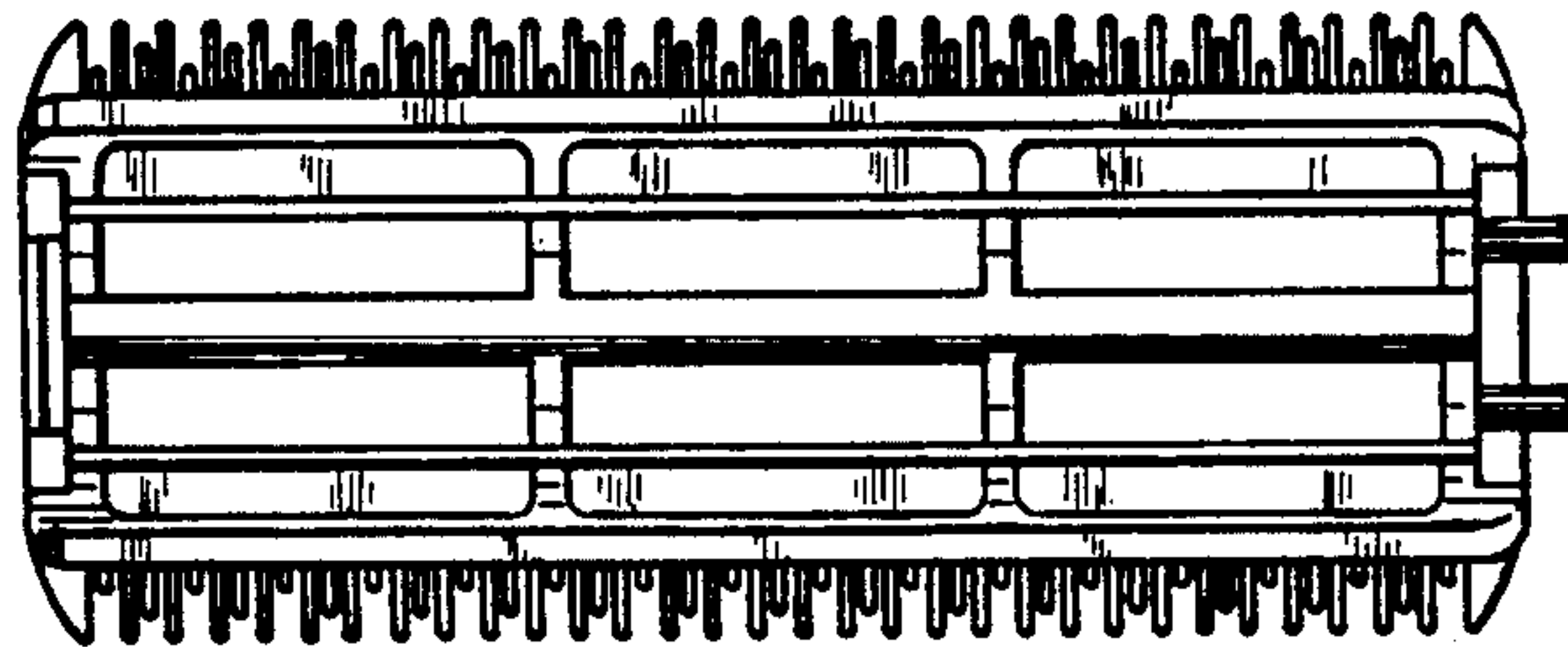

FIG. 4

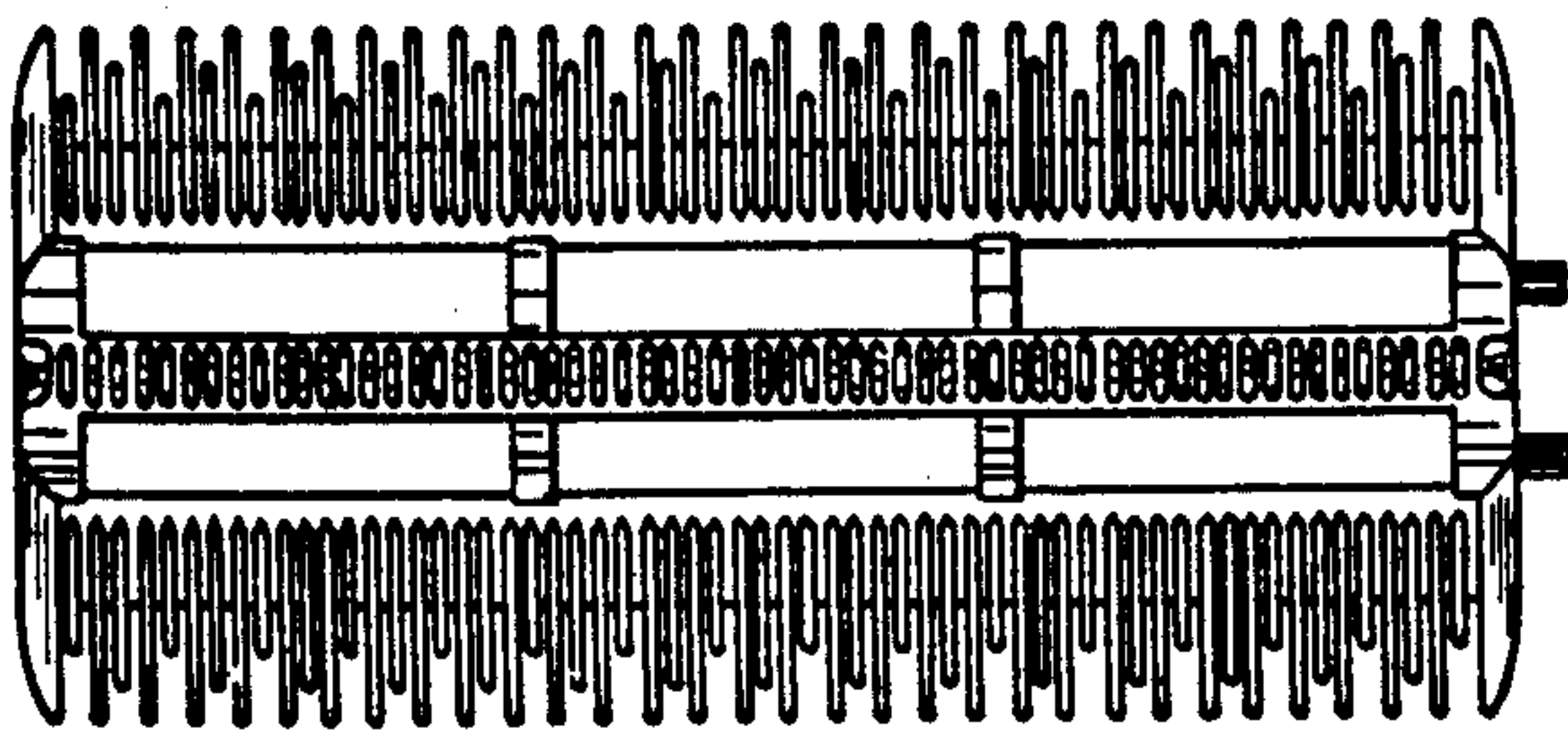

FIG. 5

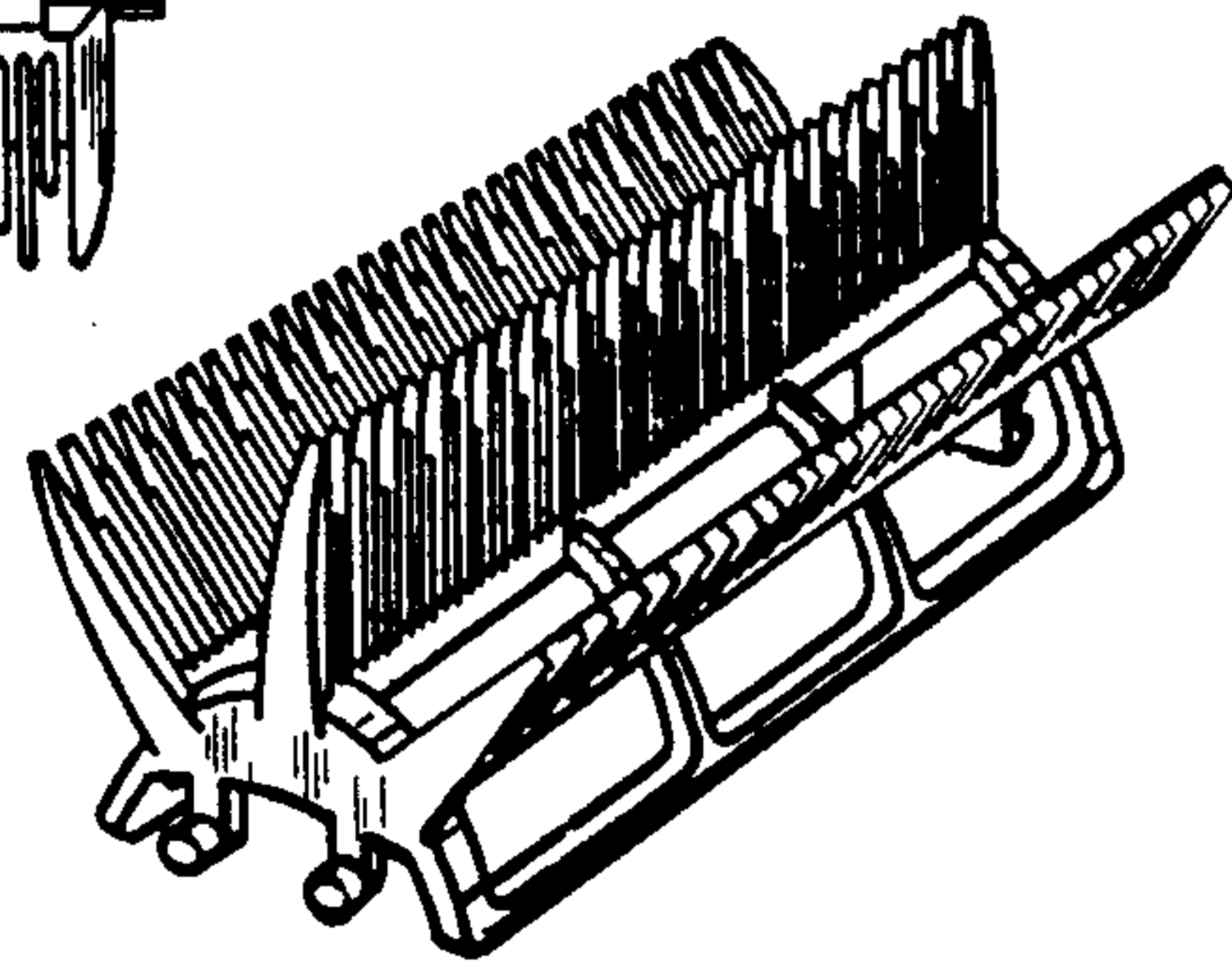

FIG. 6