

[54] AUTOMATIC BLIND SUTURING MACHINE

[76] Inventors: Kenneth B. Bess, Jr., 1400 Coral Way, Coral Gables, Fla. 32250; Benjamin D. Alleman, 17600 NW. 82nd Court, Hialeah, Fla. 33024

[\*\*] Term: 14 Years

[21] Appl. No.: 661,954

[22] Filed: Feb. 27, 1976

[51] Int. Cl. .... D24-02; D15-06

[52] U.S. Cl. .... D24/26

[58] Field of Search ..... 128/340; 112/169; D15/69, 72, 66, 78; D24/99, 26, 27

[56] References Cited

U.S. PATENT DOCUMENTS

D. 213,923 4/1969 Morris ..... D15/69

2,601,564	6/1952	Smith .....	128/340
2,988,028	6/1961	Alcamo .....	112/169
3,073,311	1/1963	Tibbs et al. ....	128/340
3,344,790	10/1967	Dorner .....	128/340

Primary Examiner—Bernard Ansher  
Attorney, Agent, or Firm—Benjamin D. Alleman

[57] CLAIM

The ornamental design for an automatic blind suturing machine, as shown.

DESCRIPTION

FIG. 1 is a top perspective view of an automatic blind suturing machine showing our new design; FIG. 2 is a top plan view thereof; FIG. 3 is an elevation view of the right side thereof; FIG. 4 is an elevation view of the back thereof; FIG. 5 is an elevation view of the front thereof; FIG. 6 is an elevation view of the left side thereof; and FIG. 7 is a bottom plan view thereof.

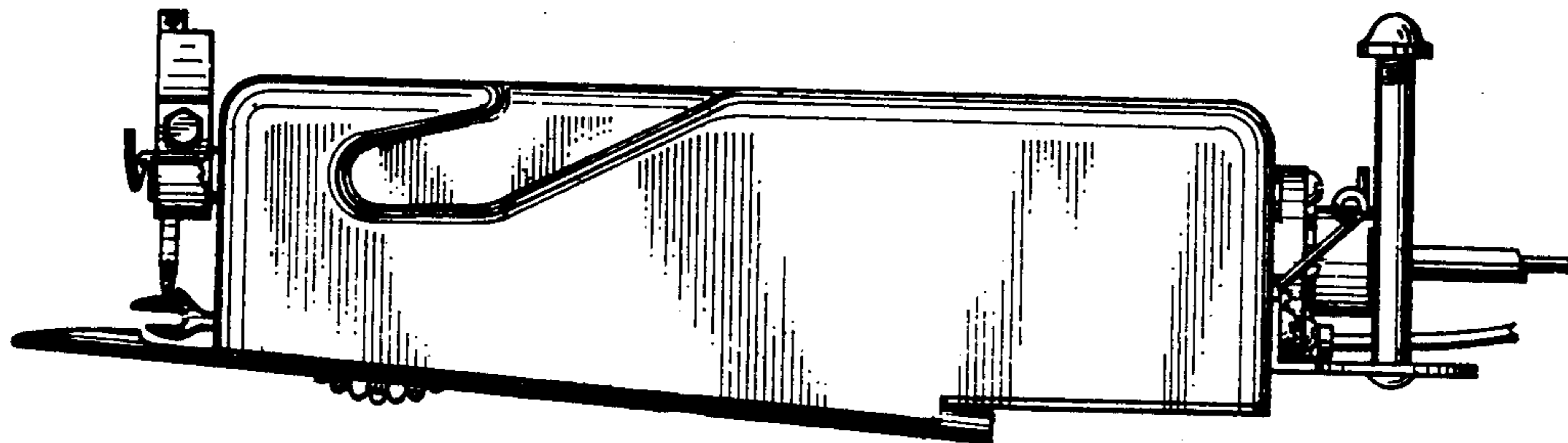
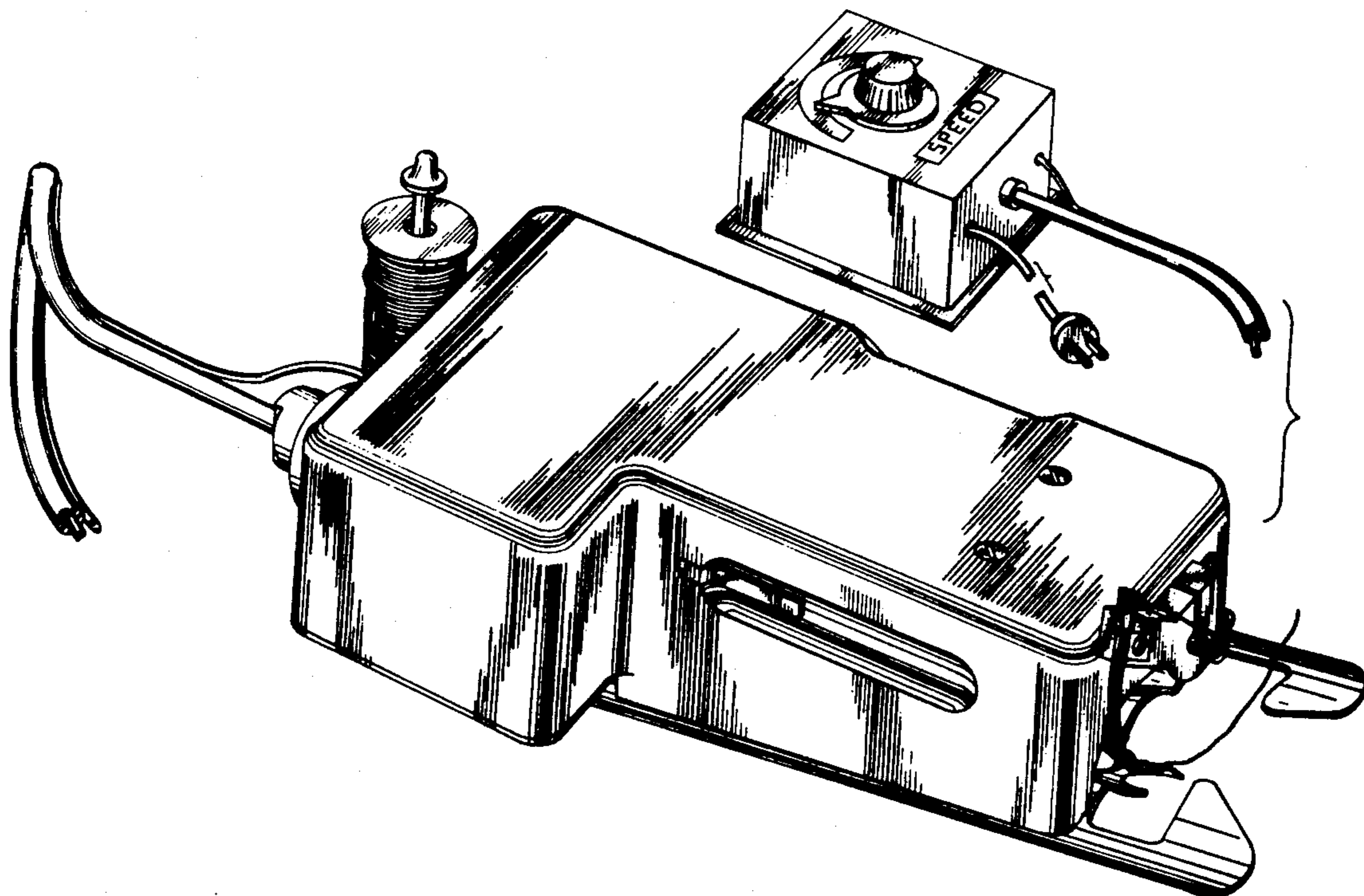

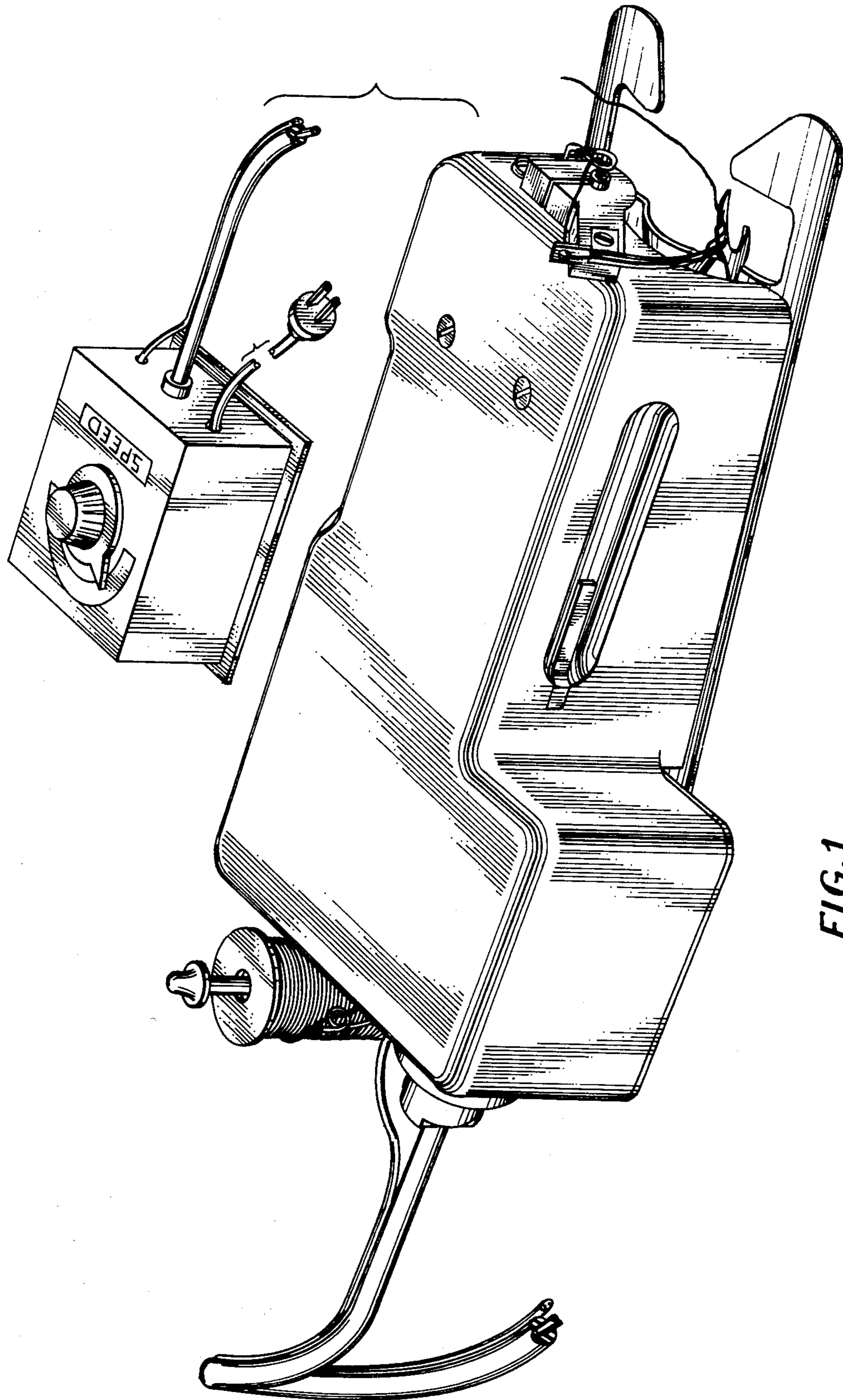

FIG. 1



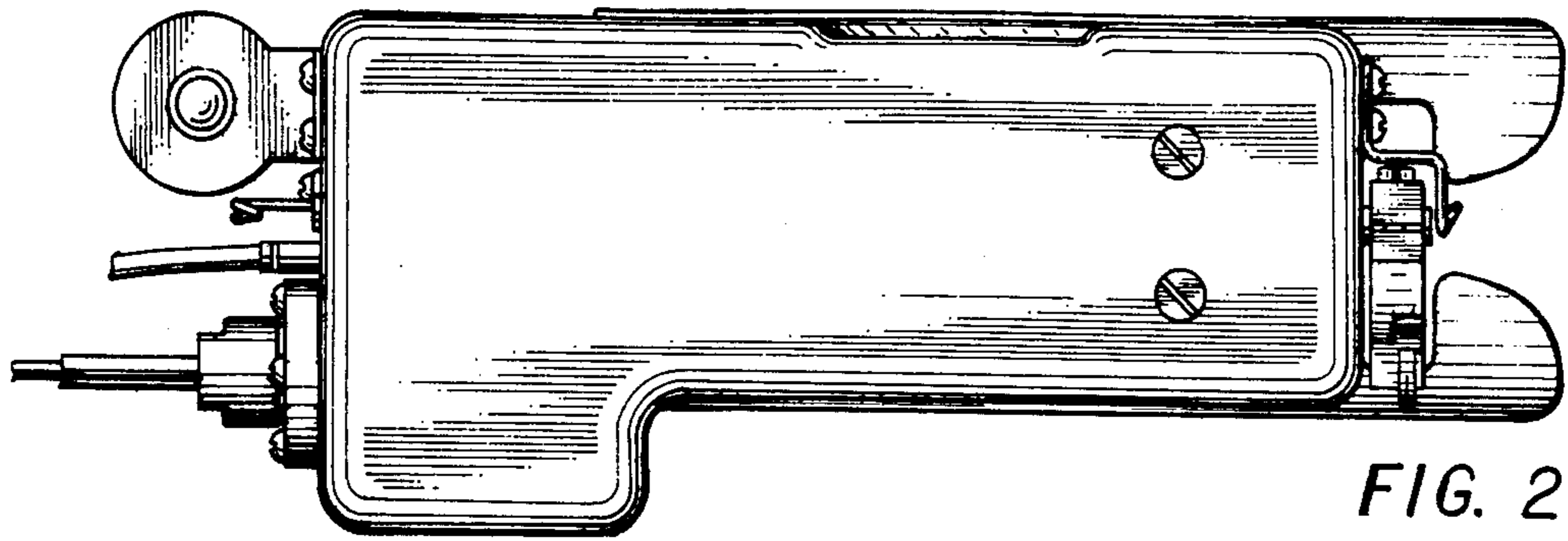

FIG. 2

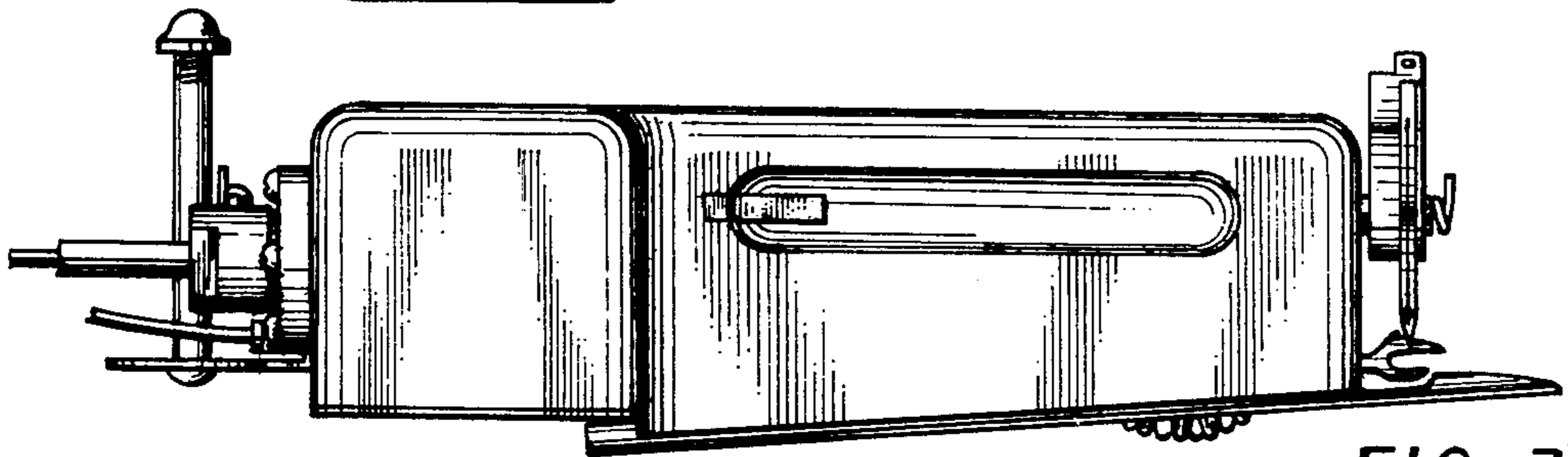

FIG. 3

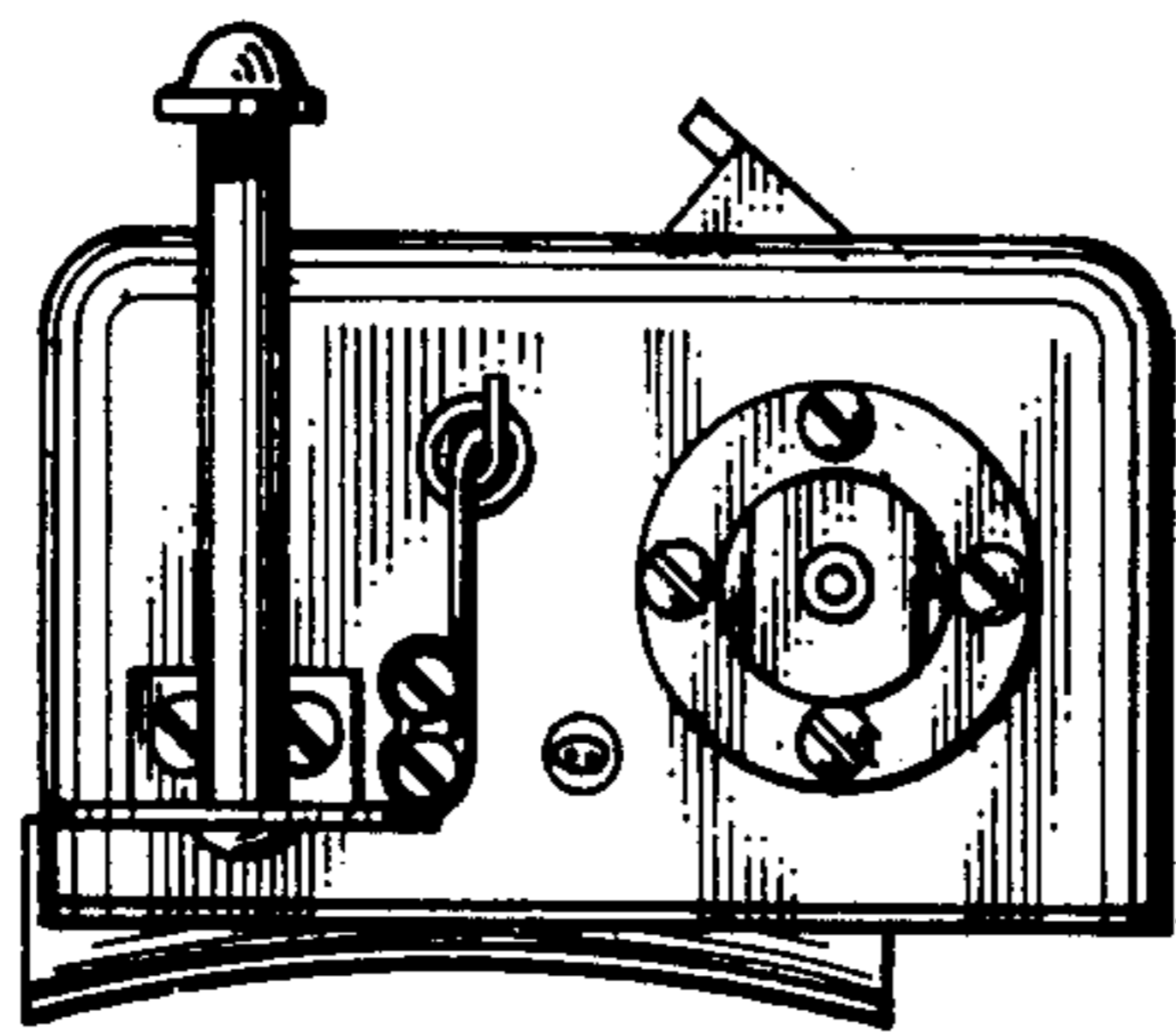

FIG. 4

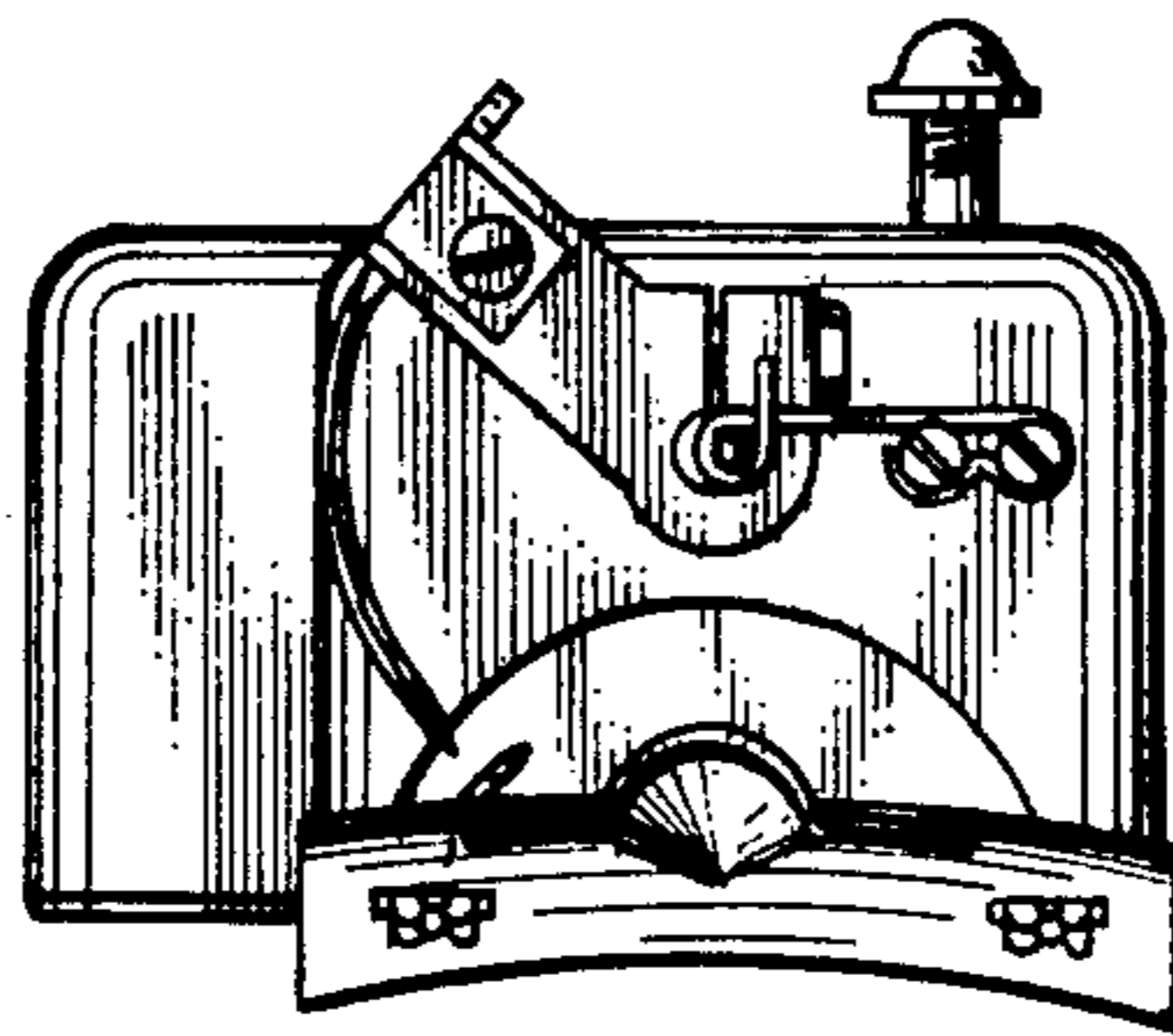

FIG. 5

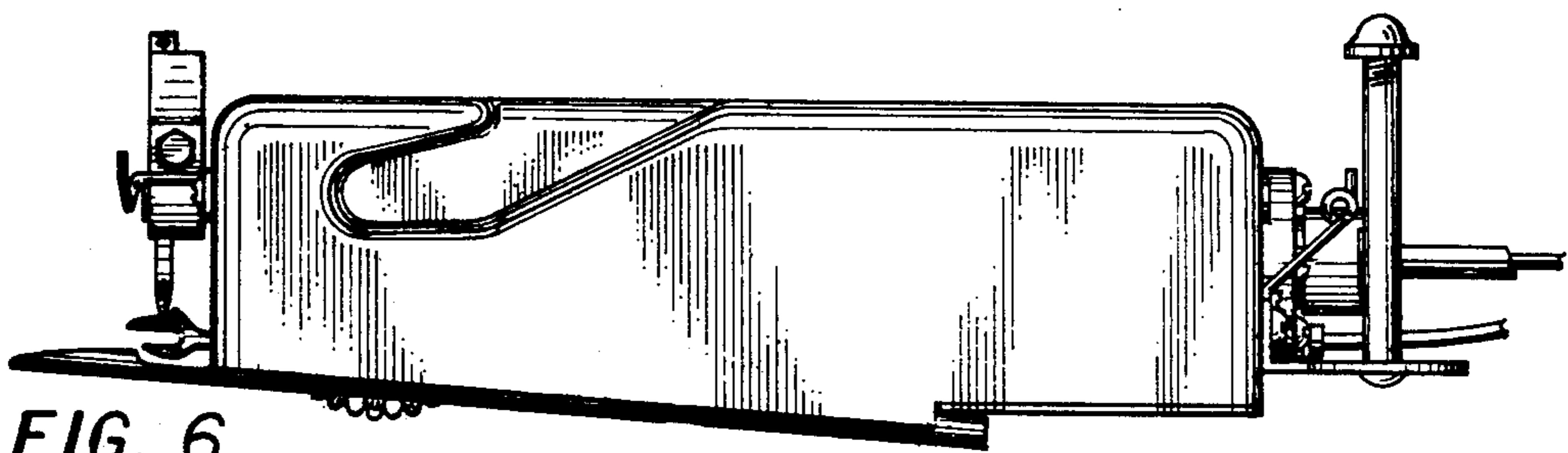

FIG. 6

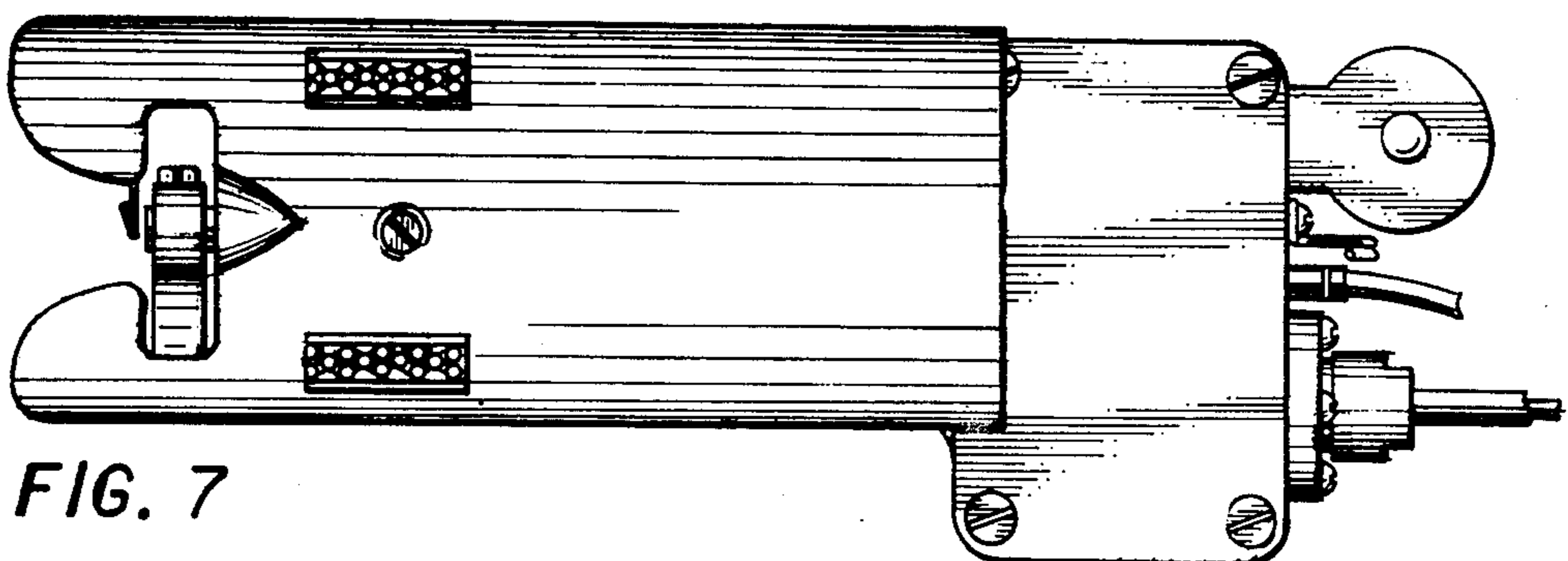

FIG. 7