

[54] MOTORCYCLE SEAT

[75] Inventor: Michael W. Hanagan, Somers, Conn.

[73] Assignee: Corbin Gentry, Inc., Somersville, Conn.

[**] Term: 14 Years

[21] Appl. No.: 688,341

[22] Filed: May 20, 1976

[51] Int. Cl. D12-11

[52] U.S. Cl. D6/48.1

[58] Field of Search D6/48.1; 297/195, 214, 297/243

[56] References Cited

U.S. PATENT DOCUMENTS

- D. 238,220 12/1975 Hanagan D6/48.1
- D. 238,221 12/1975 Hanagan D6/48.1

OTHER PUBLICATIONS

Cycle, 4/76, p. 119, Mineola Touring Seat, lower center of page.

Cycle, 4/76, p. 38, Motorcycle Seat, top center of page.
Cycle, 4/76, p. 19, Motorcycle Seat, top right side of page.

J. C. Whitney Catalog No. 348, p. G, Touring Saddle Seat, upper left side of page.

Primary Examiner—Wallace R. Burke

Assistant Examiner—James M. Gandy

Attorney, Agent, or Firm—Peter L. Costas

[57] CLAIM

The ornamental design for a motorcycle seat, as shown.

DESCRIPTION

FIG. 1 is a top plan view of a motorcycle seat showing my new design;

FIG. 2 is a side elevational view thereof;

FIG. 3 is a bottom plan view thereof;

FIG. 4 is a front elevational view thereof; and

FIG. 5 is a rear elevational view thereof.

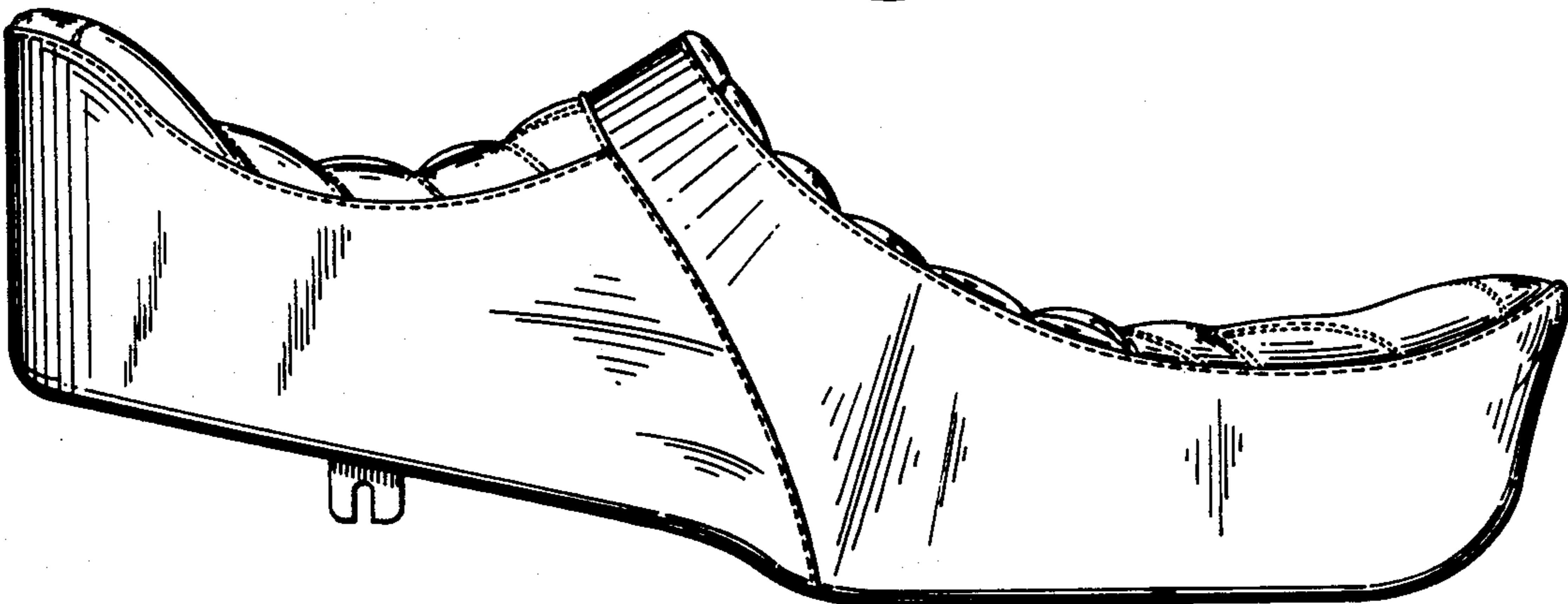
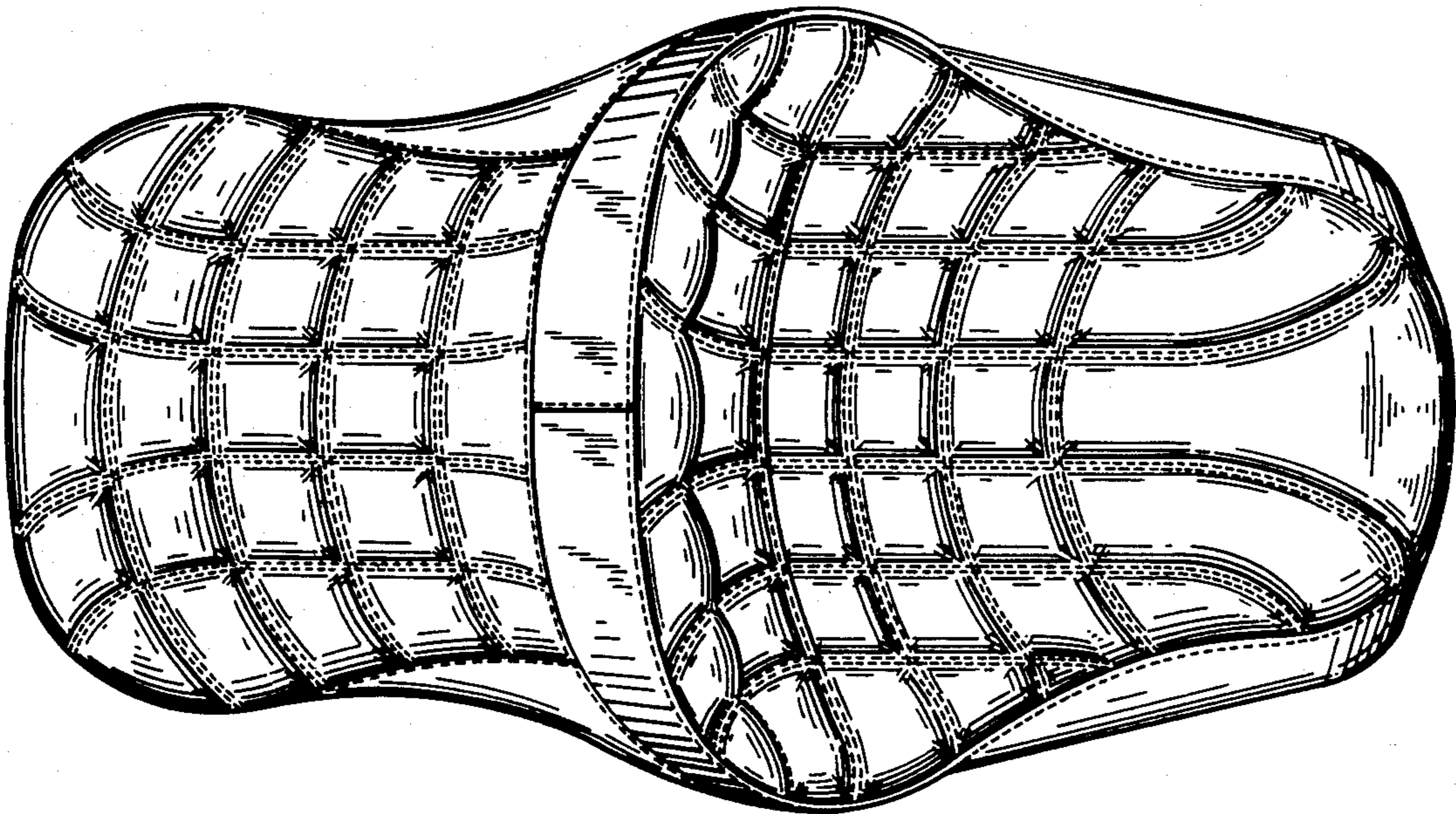

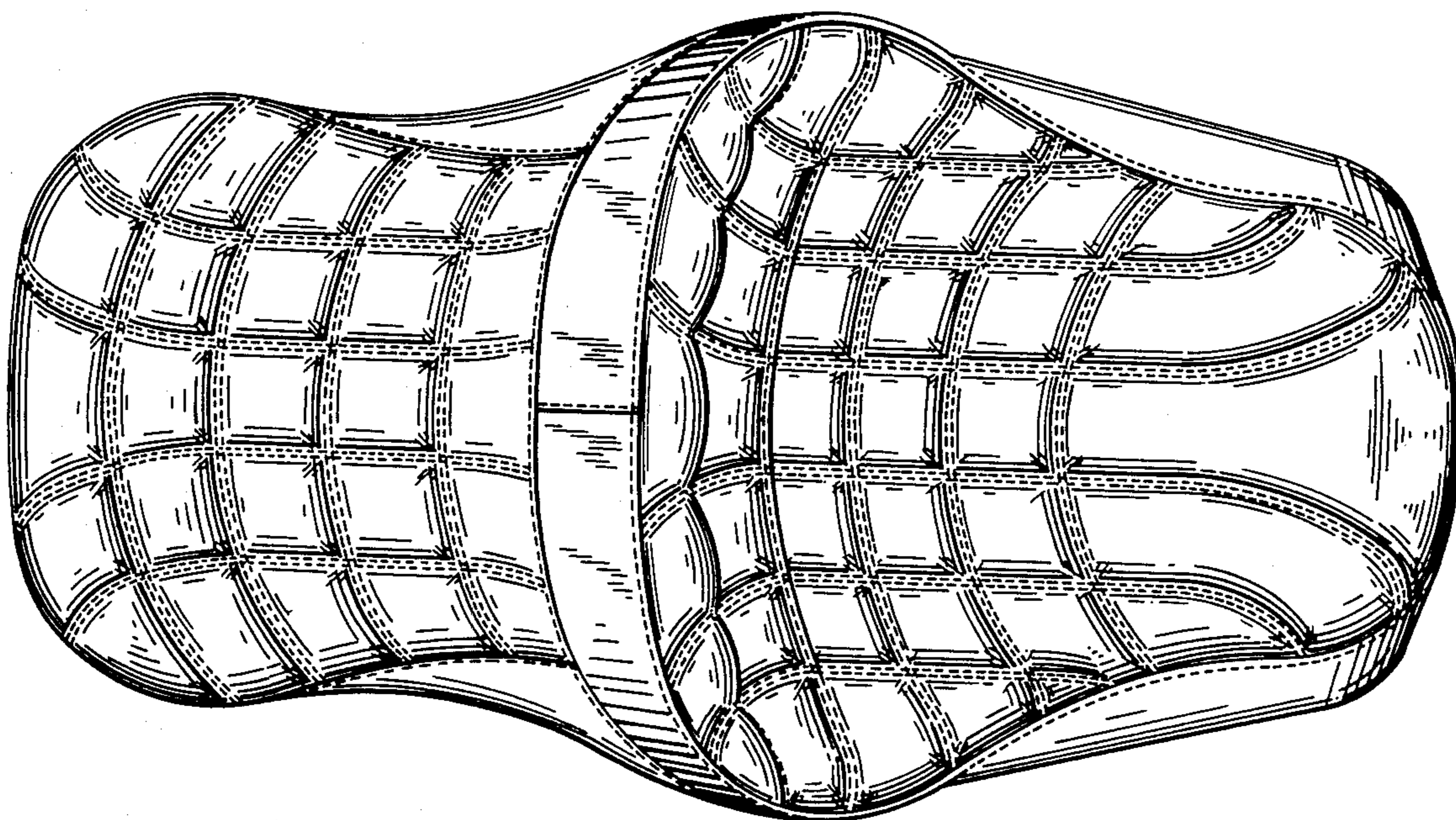

FIG. 1

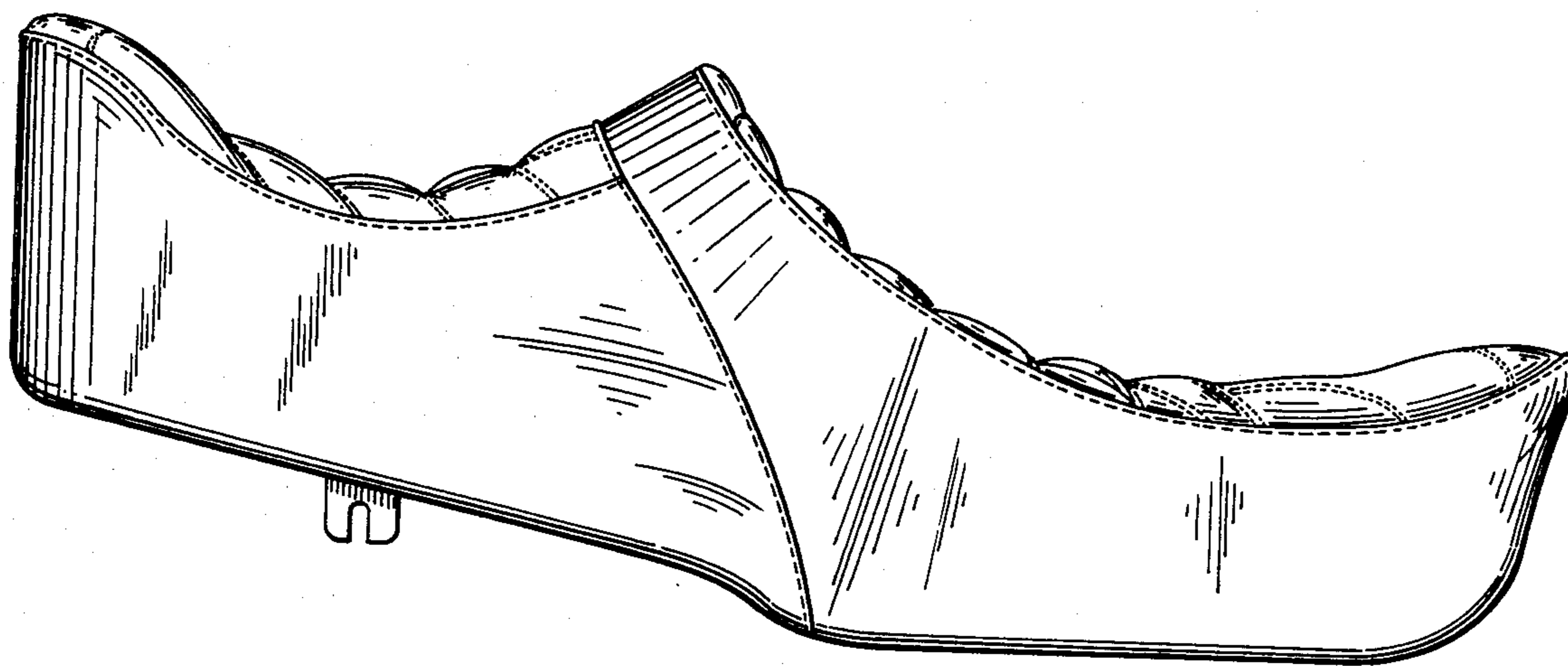

FIG. 2

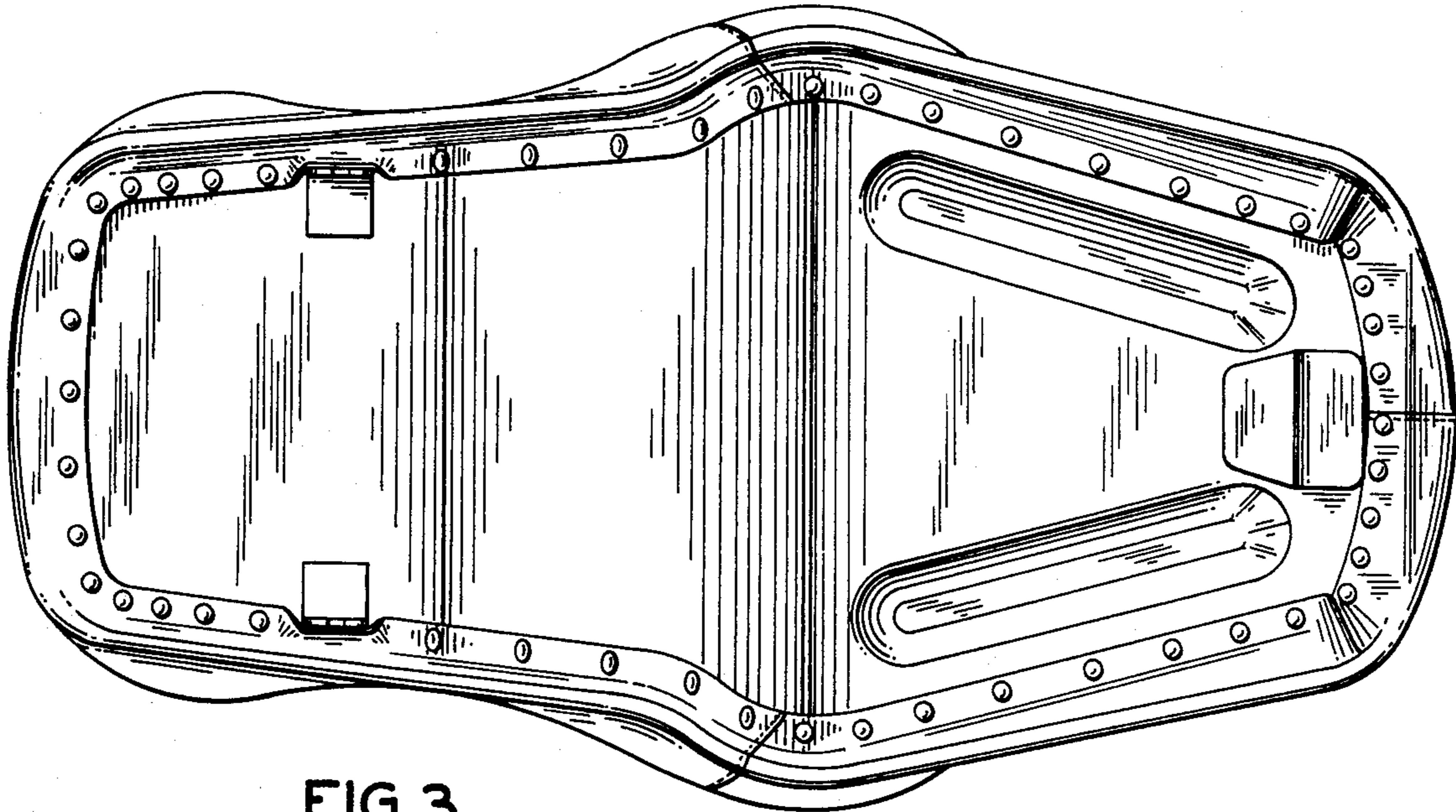

FIG. 3

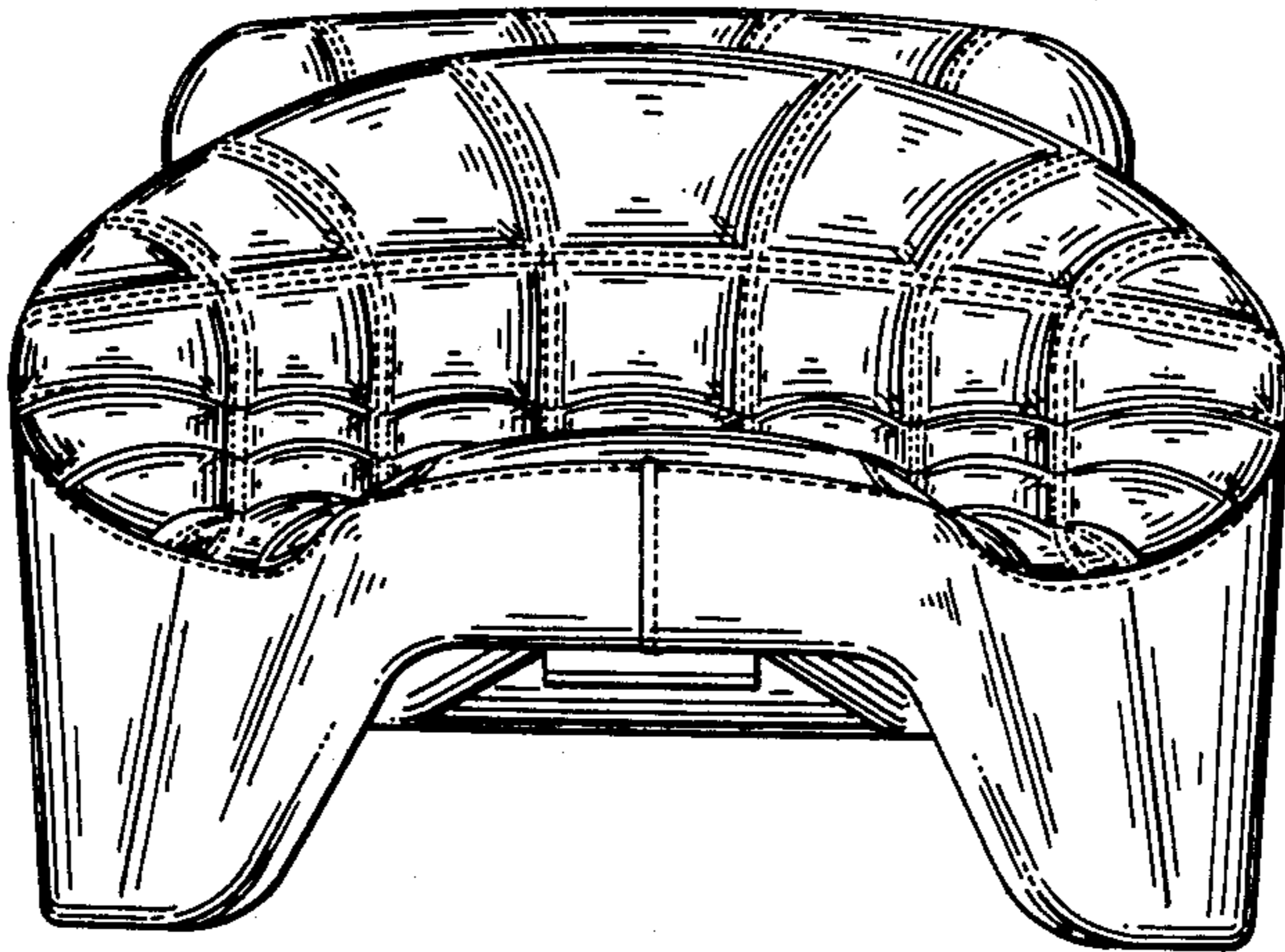

FIG. 4

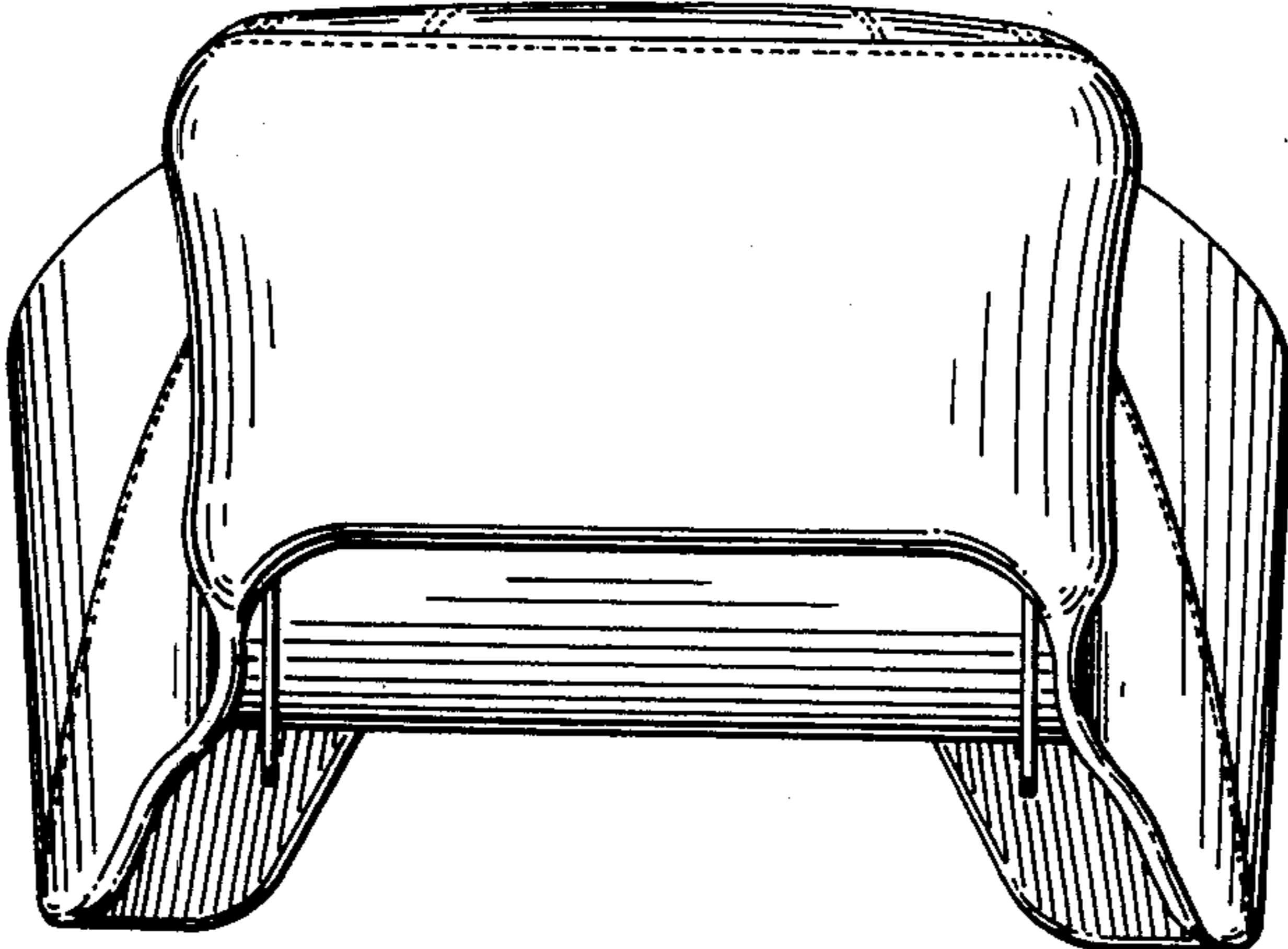

FIG. 5