

# United States Patent [19]

Tomaro

[11] Des. 246,730

[45] \*\* Dec. 20, 1977

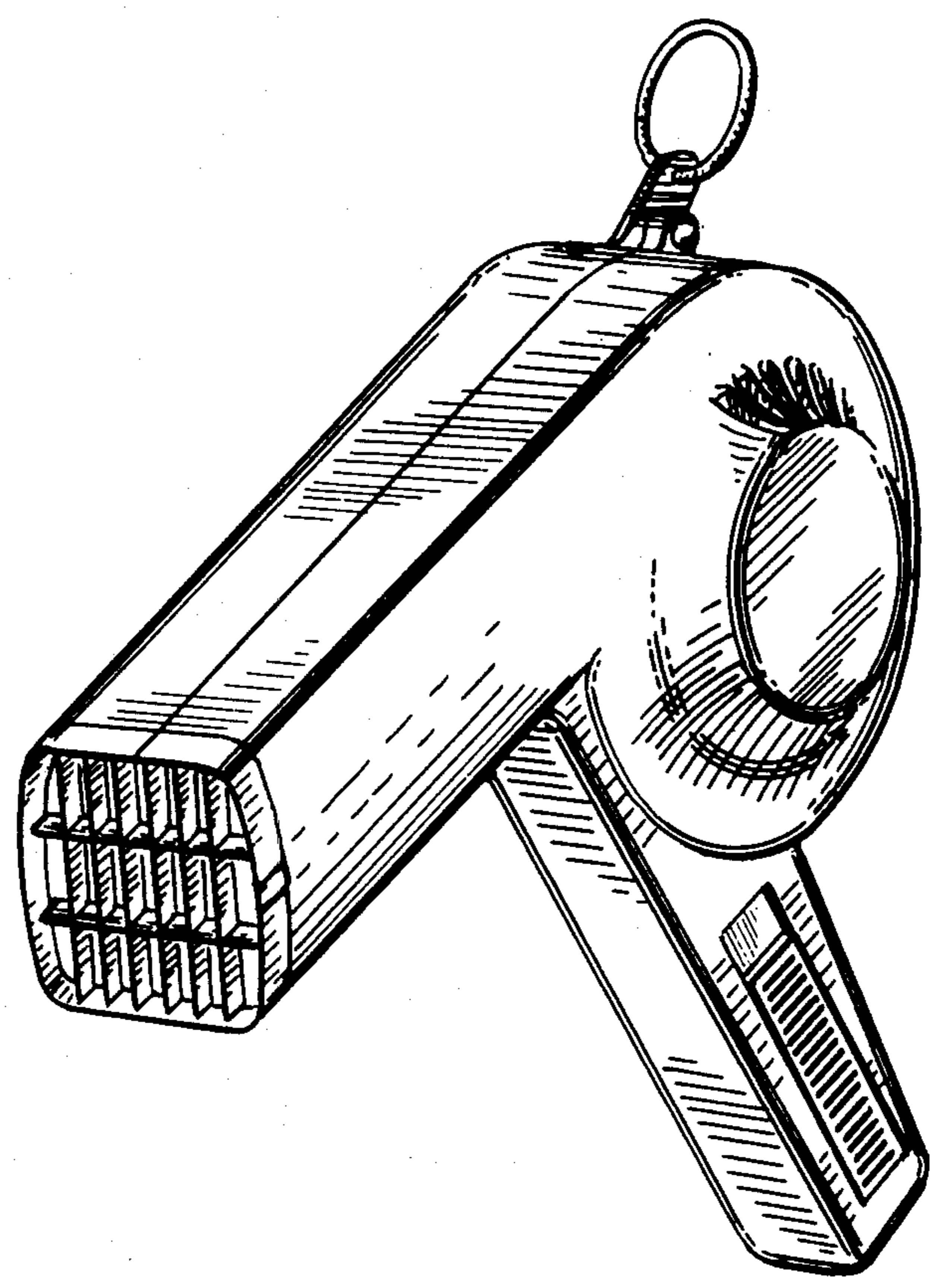
- [54] **ELECTRIC HAIR DRYER**
- [75] Inventor: **Patrick M. Tomaro**, Maplewood, N.J.
- [73] Assignee: **Conair Corporation**, Edison, N.J.
- [\*\*] Term: **14 Years**
- [21] Appl. No.: **691,194**
- [22] Filed: **May 28, 1976**
- [51] Int. Cl. .... **D28—03**
- [52] U.S. Cl. .... **D28/13**
- [58] Field of Search ..... **D28/9, 10, 12-16, D28/18, 24; D4/13, 14, 17; 219/222; 34/96-101; 132/7, 9, 11 R, 11 A, 118**

- [56] **References Cited**  
**U.S. PATENT DOCUMENTS**  
D. 238,009 12/1975 Long et al. .... D28/13  
D. 243,368 2/1977 Nagelkerke ..... D28/13

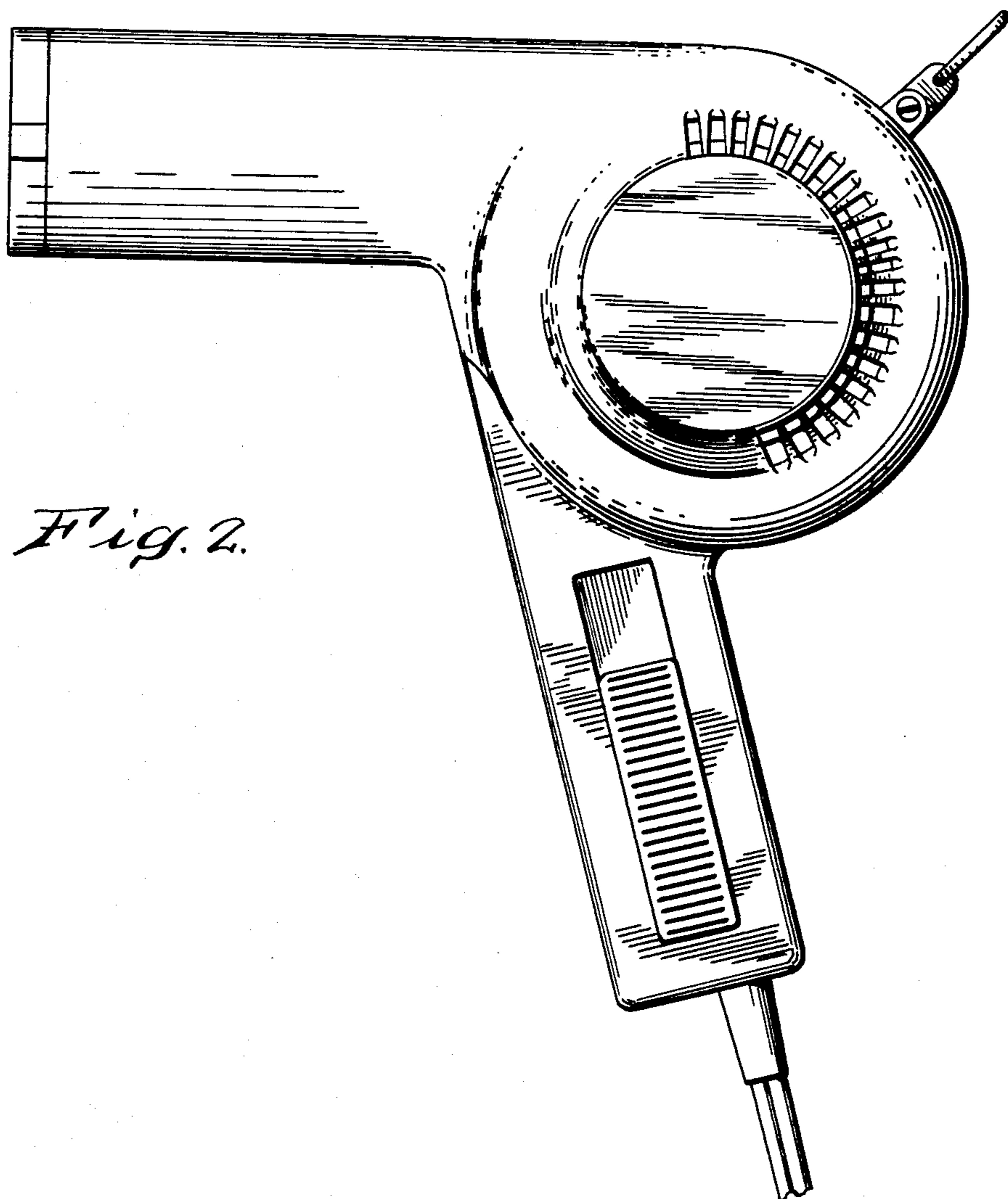
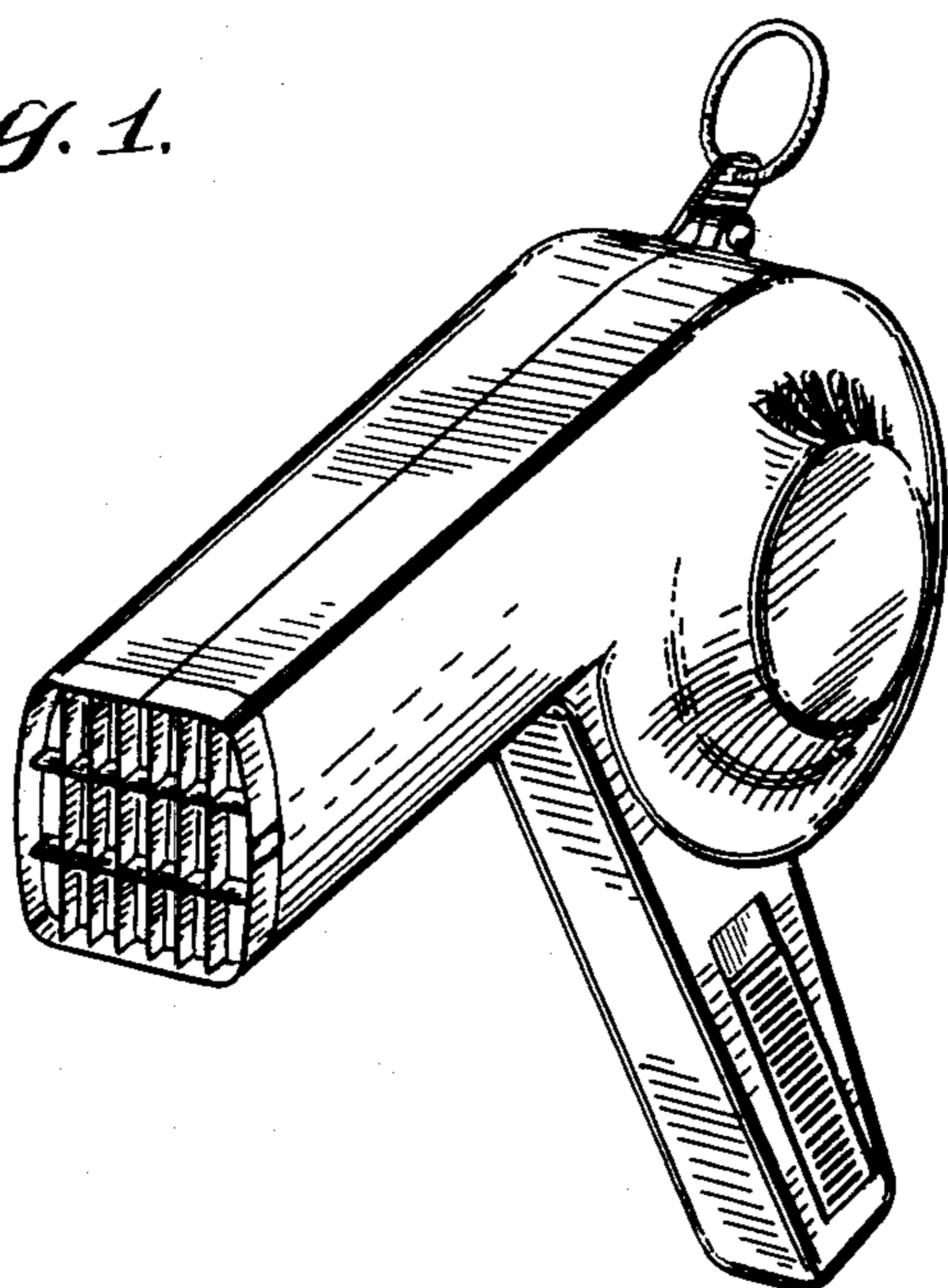
D. 243,418 2/1977 Wolff ..... D28/13  
*Primary Examiner*—Joel Stearman  
*Assistant Examiner*—Louis S. Zarfes  
*Attorney, Agent, or Firm*—Haynes N. Johnson

[57] **CLAIM**  
The ornamental design for an electric hair dryer, substantially as shown and described.

**DESCRIPTION**  
FIG. 1 is a left side perspective view of an electric hair dryer showing my new design;  
FIG. 2 is a left side elevational view;  
FIG. 3 is a rear elevational view;  
FIG. 4 is a right side elevational view;  
FIG. 5 is a front elevational view;  
FIG. 6 is a top plan view; and  
FIG. 7 is a bottom plan view.  
In the foregoing views, the cord is shown only partially for convenience of illustration.

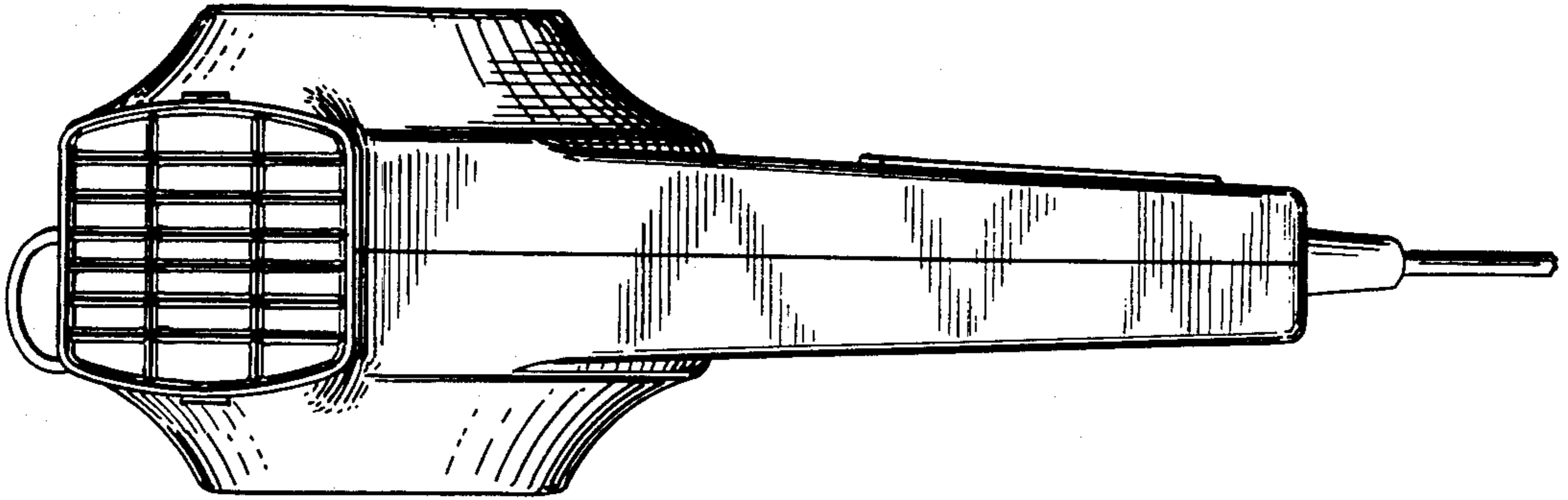


*Fig. 1.*

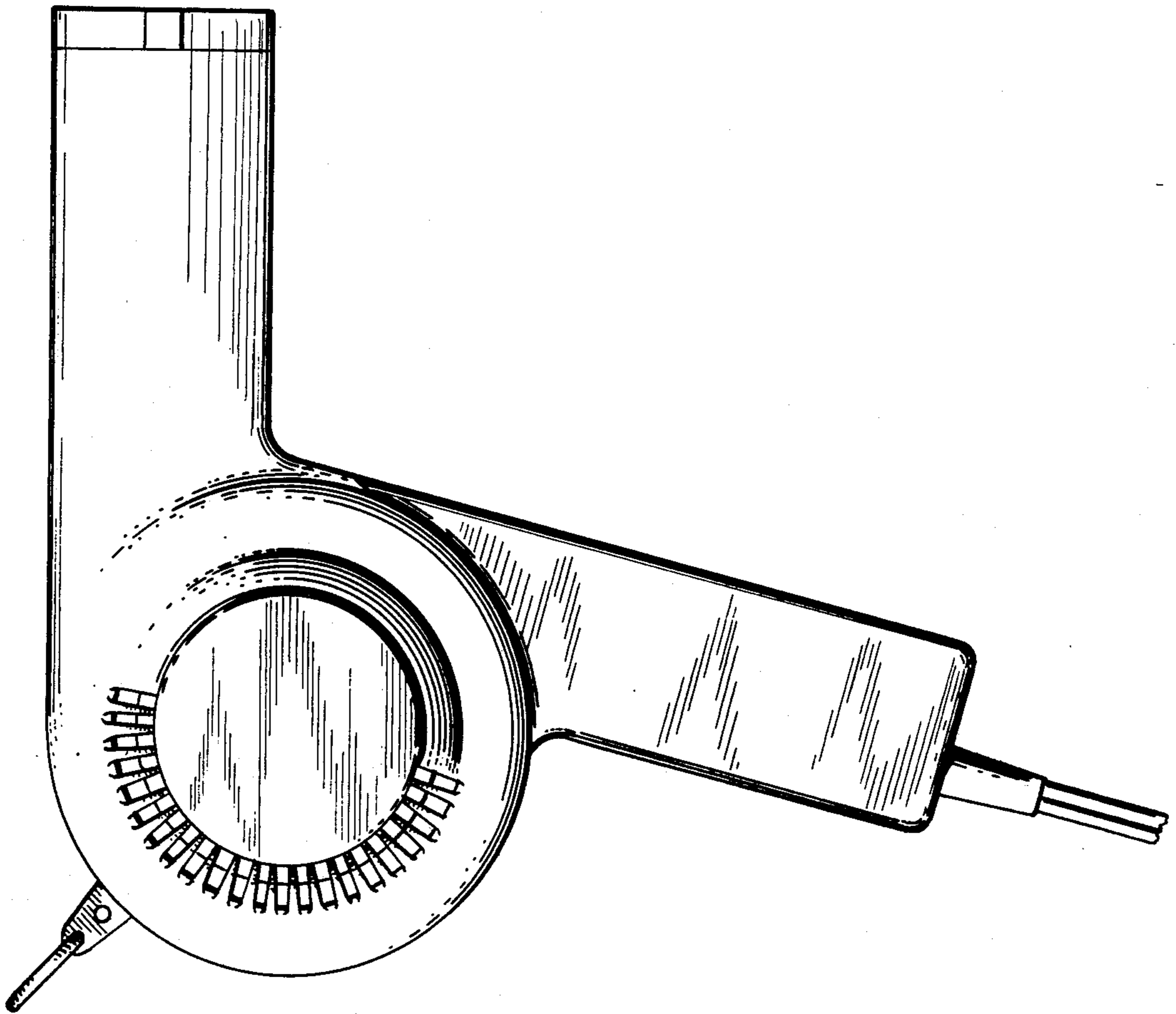


*Fig. 2.*

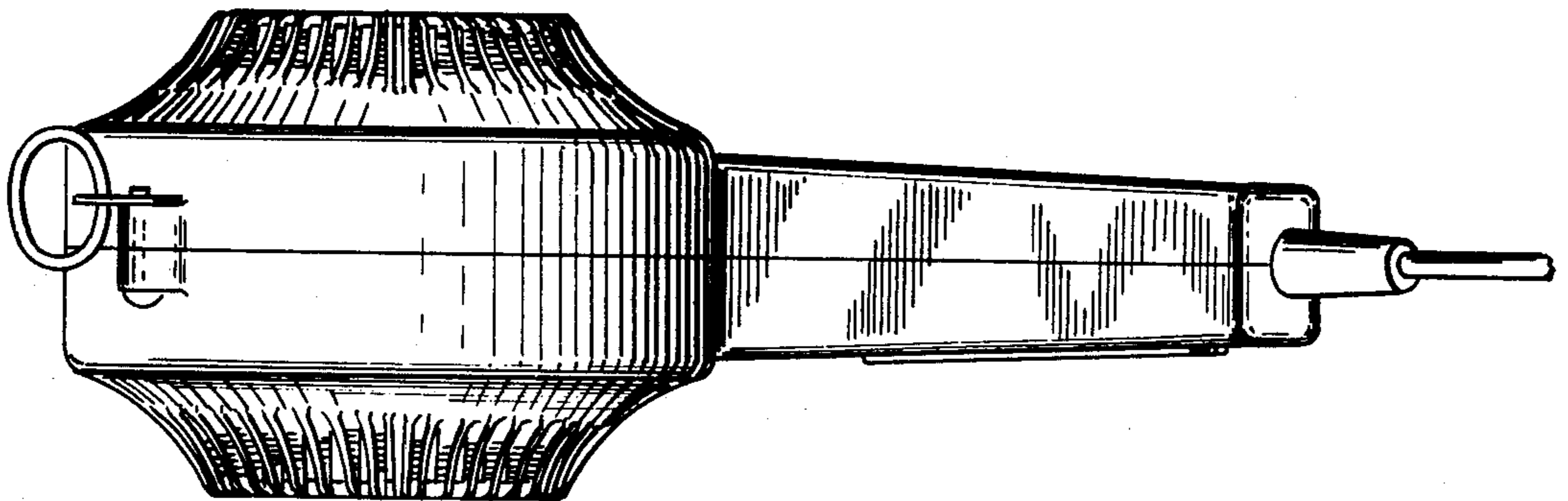
*Fig. 5.*



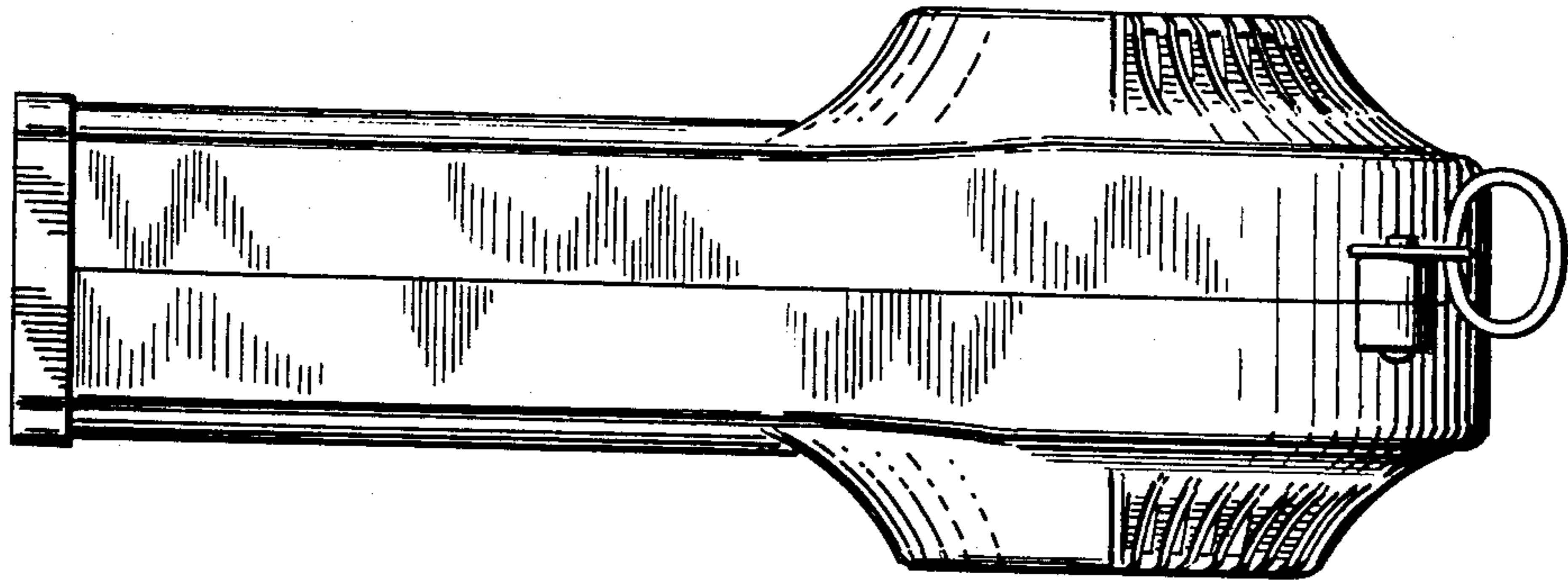
*Fig. 4.*



*Fig. 3.*



*Fig. 6.*



*Fig. 7.*

