

United States Patent [19]

Gulley et al.

[11] Des. 246,632

[45] ** Dec. 13, 1977

[54] BOTTLE

[75] Inventors: Don R. Gulley; Theodore G. Schad, Jr., both of Lafayette, La.

[73] Assignee: Lou Ana Foods, Inc., Opelousas, La.

[**] Term: 14 Years

[21] Appl. No.: 645,209

[22] Filed: Dec. 29, 1975

[51] Int. Cl. D9-01

[52] U.S. Cl. D9/42

[58] Field of Search D9/38-53;
215/1 R, 1 C

[56] **References Cited**

U.S. PATENT DOCUMENTS

D. 196,324 9/1963 Sterges D9/42

D. 212,456 10/1968 Vanderhyde D9/42
D. 224,733 9/1972 Vanderhyde D9/42
D. 233,825 12/1974 Thomas D9/41
D. 237,253 10/1975 Schweizer D9/42

Primary Examiner—Robert C. Spangler
Attorney, Agent, or Firm—John W. Malley

[57] **CLAIM**

The ornamental design for a bottle, as shown.

DESCRIPTION

FIG. 1 is a side elevation view of a bottle showing our new design;
FIG. 2 is a rear elevation view thereof;
FIG. 3 is a top plan view thereof;
FIG. 4 is a bottom plan view thereof;
FIG. 5 is a transverse cross-sectional view of the handle thereof, taken on line 5-5 of FIG. 1; and
FIG. 6 is a fragmentary sectional view taken on line 6-6 of FIG. 1.

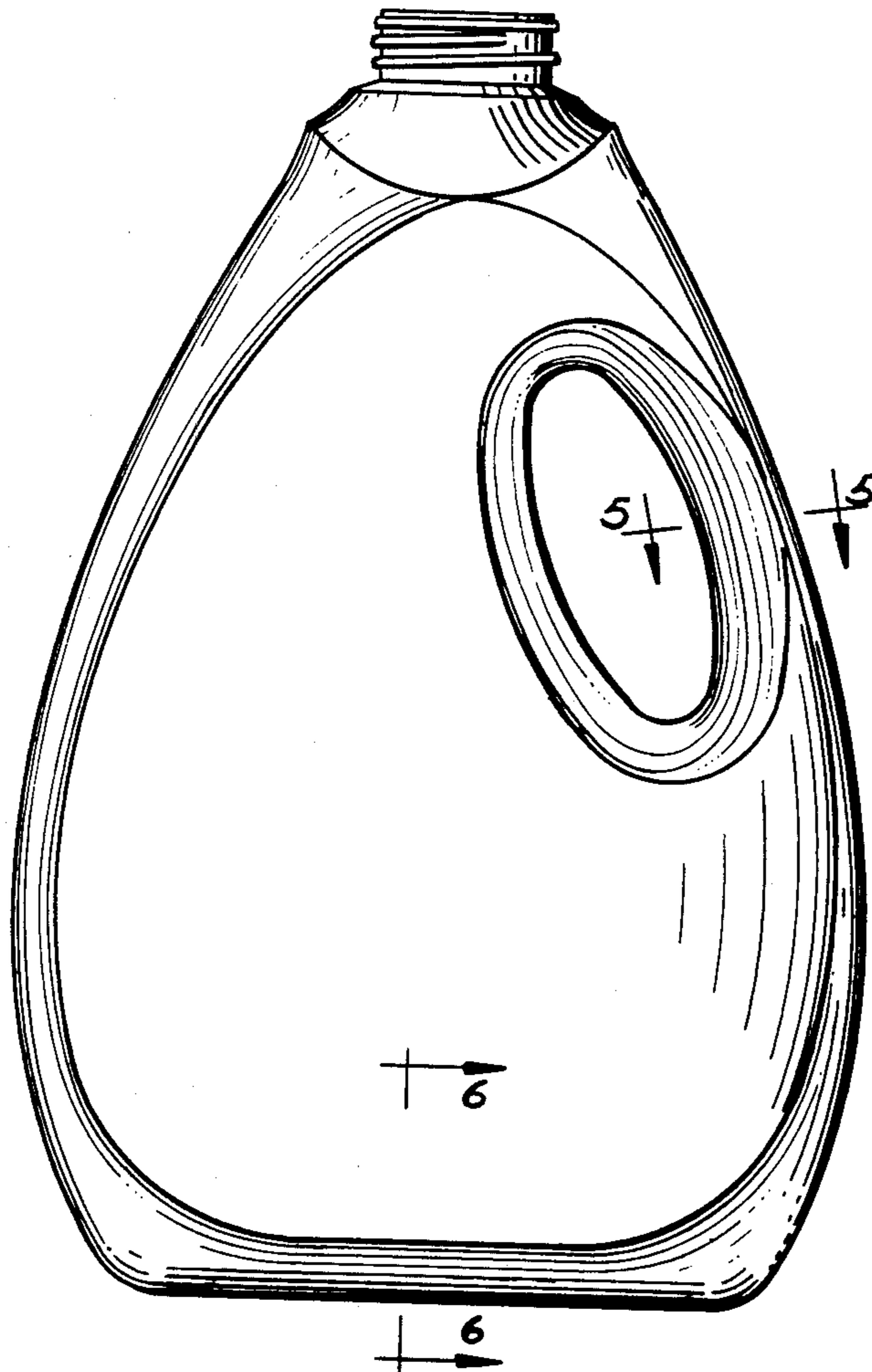

Fig. 1.

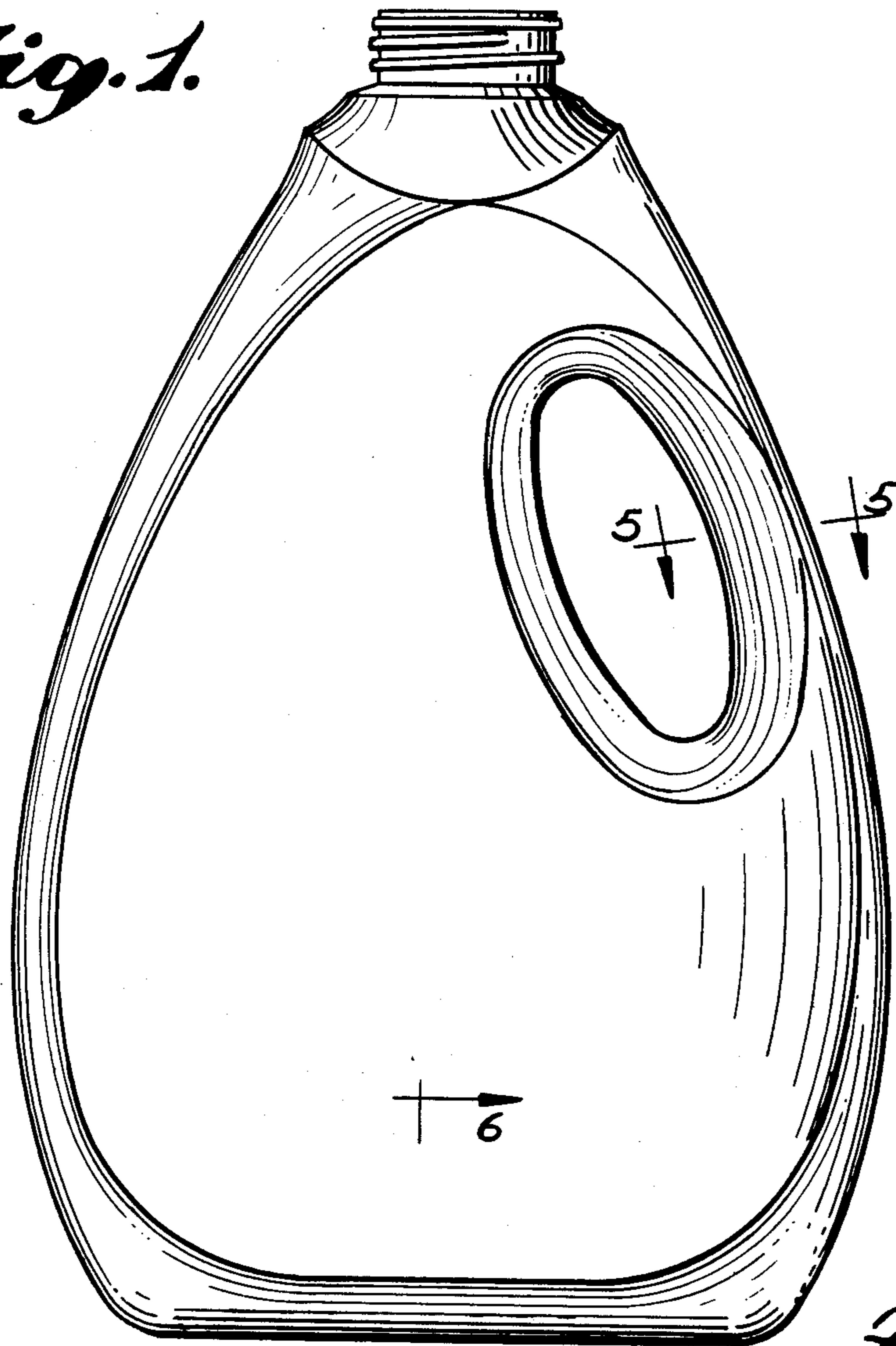

Fig. 4.

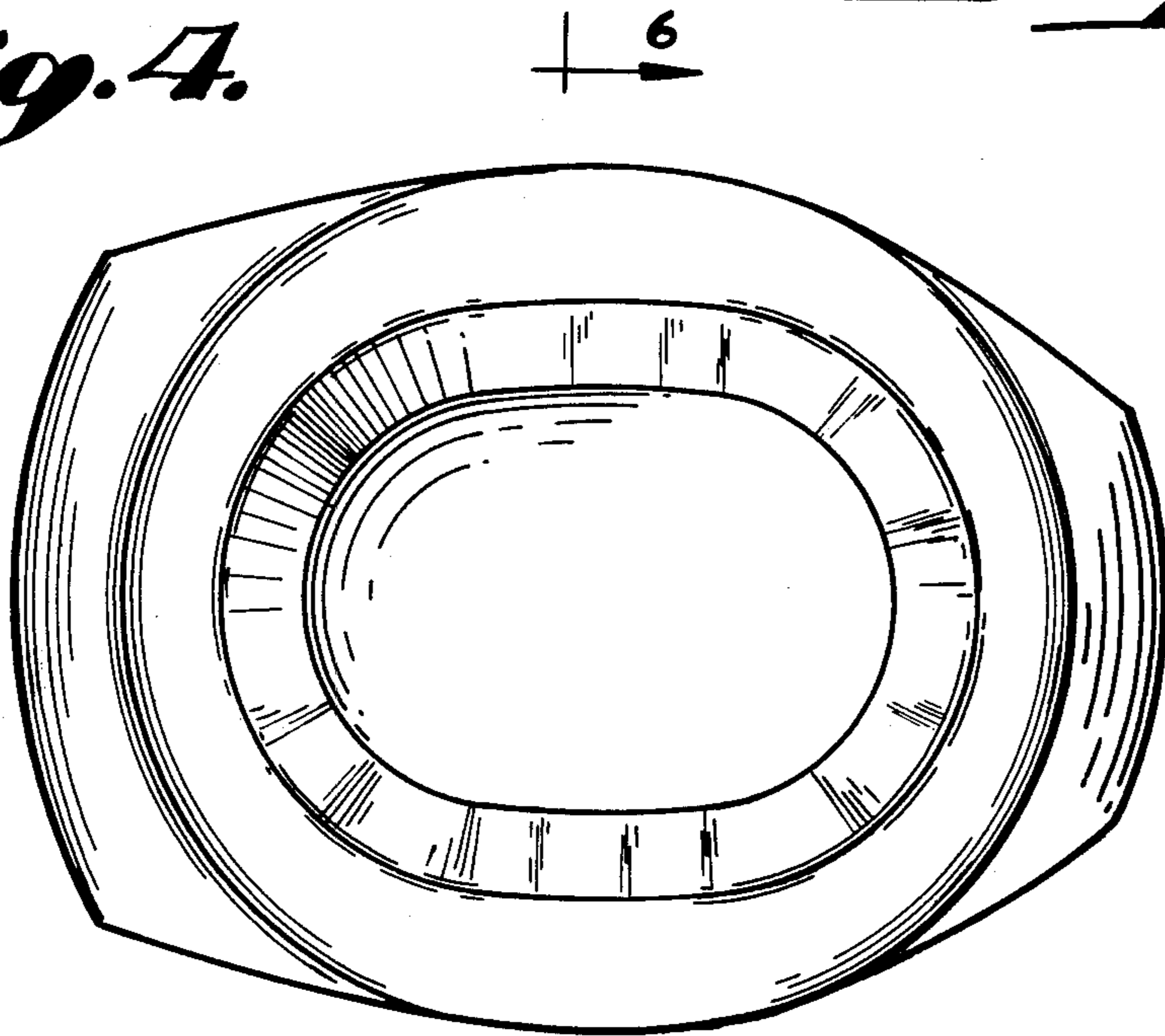
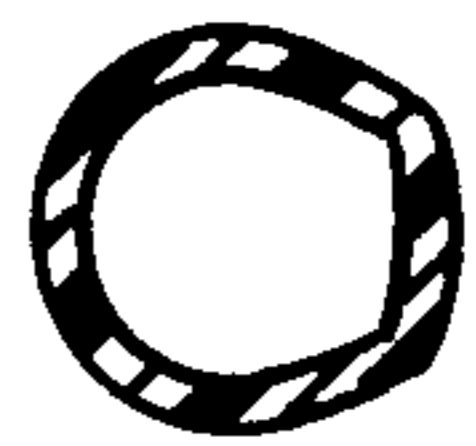

Fig. 5.



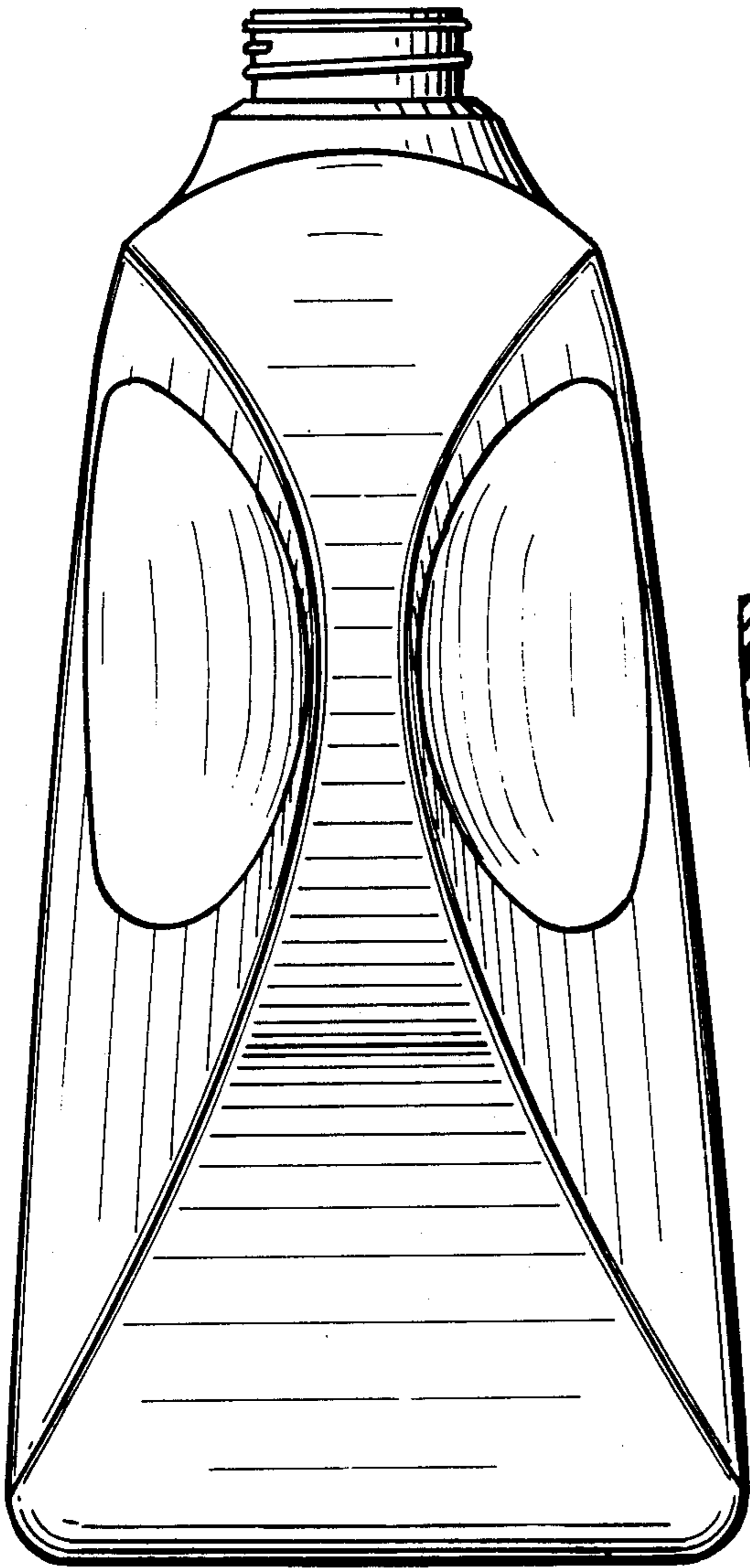

Fig. 2.

Fig. 6.

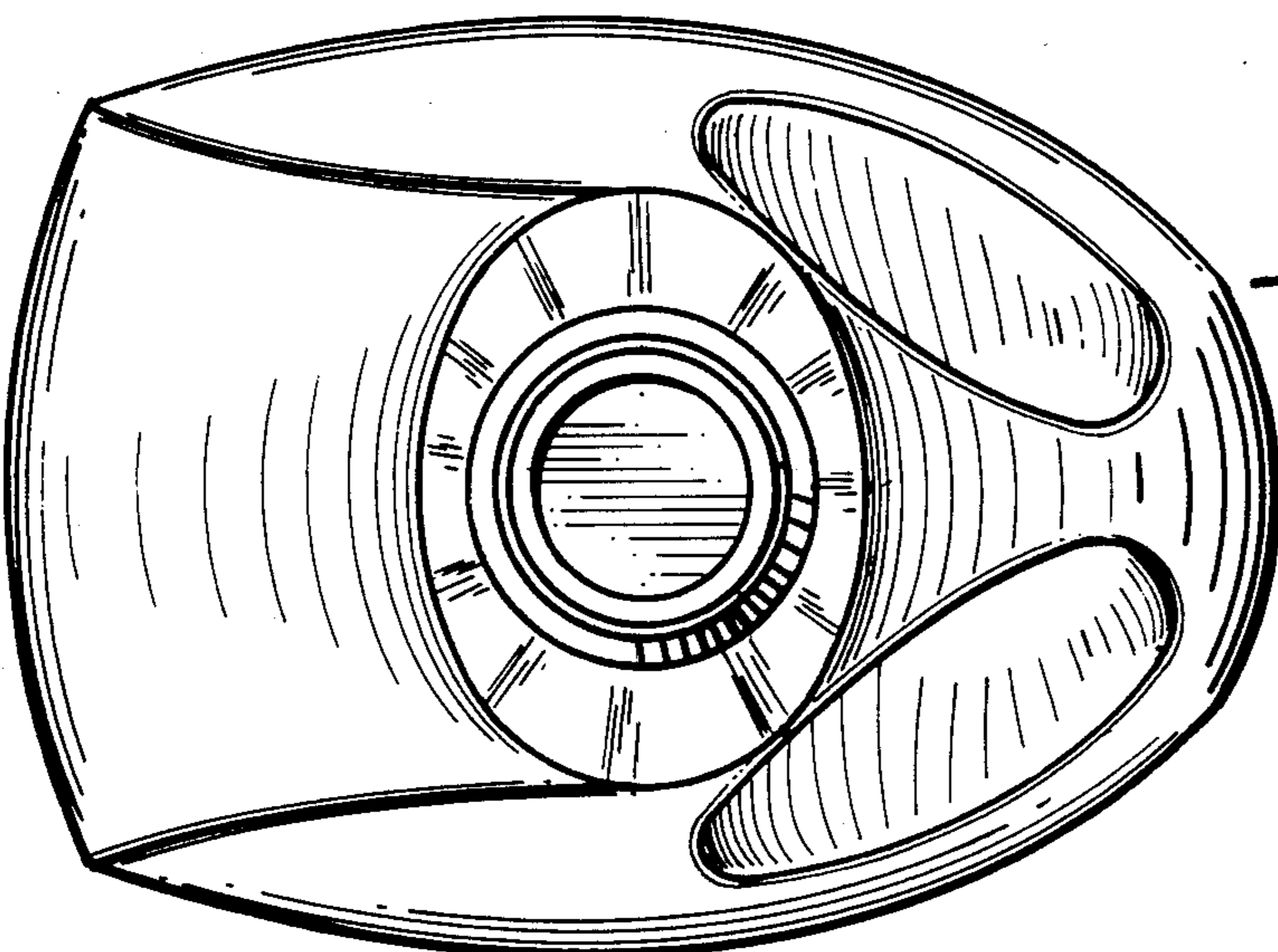
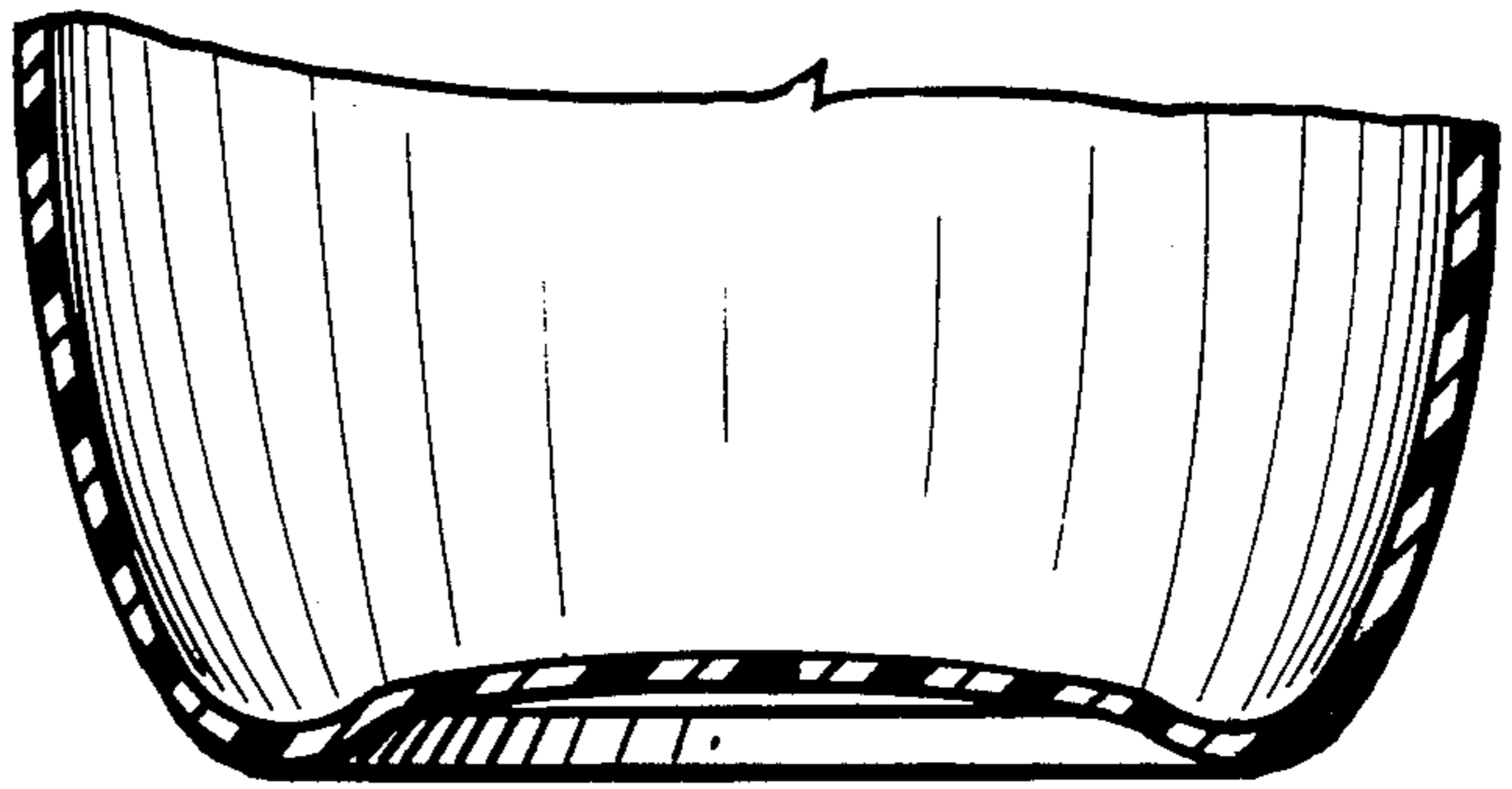

Fig. 3.