

[54] MULTI-PURPOSE TOOL

[76] Inventor: Melvin D. Bricker, 107 Miromor Road, No. B, Alameda, Calif. 94501

[**] Term: 14 Years

[21] Appl. No.: 689,108

[22] Filed: May 24, 1976

[51] Int. Cl. D8-05

[52] U.S. Cl. D8/26

[58] Field of Search D8/26, 27, 28; 7/1 G

[56] References Cited

U.S. PATENT DOCUMENTS

D. 209,705 12/1967 Hobbs D8/26

Primary Examiner—Alan P. Douglas

Attorney, Agent, or Firm—William R. Piper

[57] CLAIM

The ornamental design for a multi-purpose tool, substantially as shown.

DESCRIPTION

FIG. 1 is a side elevation of the multi-purpose tool; FIG. 2 is a top plan view of the tool; FIG. 3 is a side elevation of the tool when looking at the opposite side from that shown in FIG. 1; FIG. 4 is an end view of the tool when looking at the left hand end of FIG. 3; FIG. 5 is an end view of the tool when looking at the right hand end of FIG. 3; FIG. 6 is a bottom plan view of the tool; and FIG. 7 is a transverse section through the tool and is taken along the line 7-7 of FIG. 6.

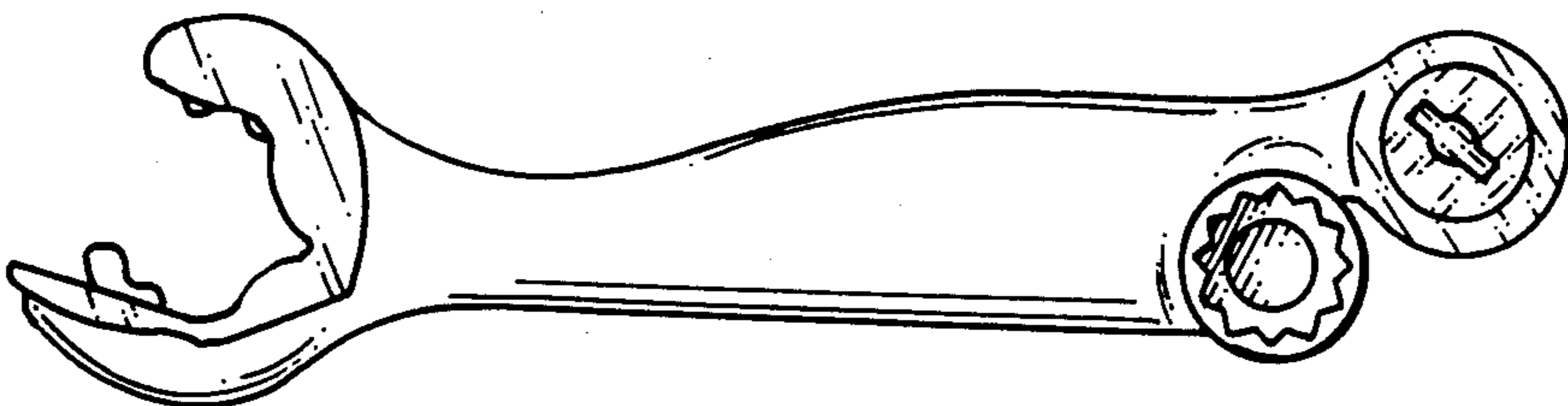
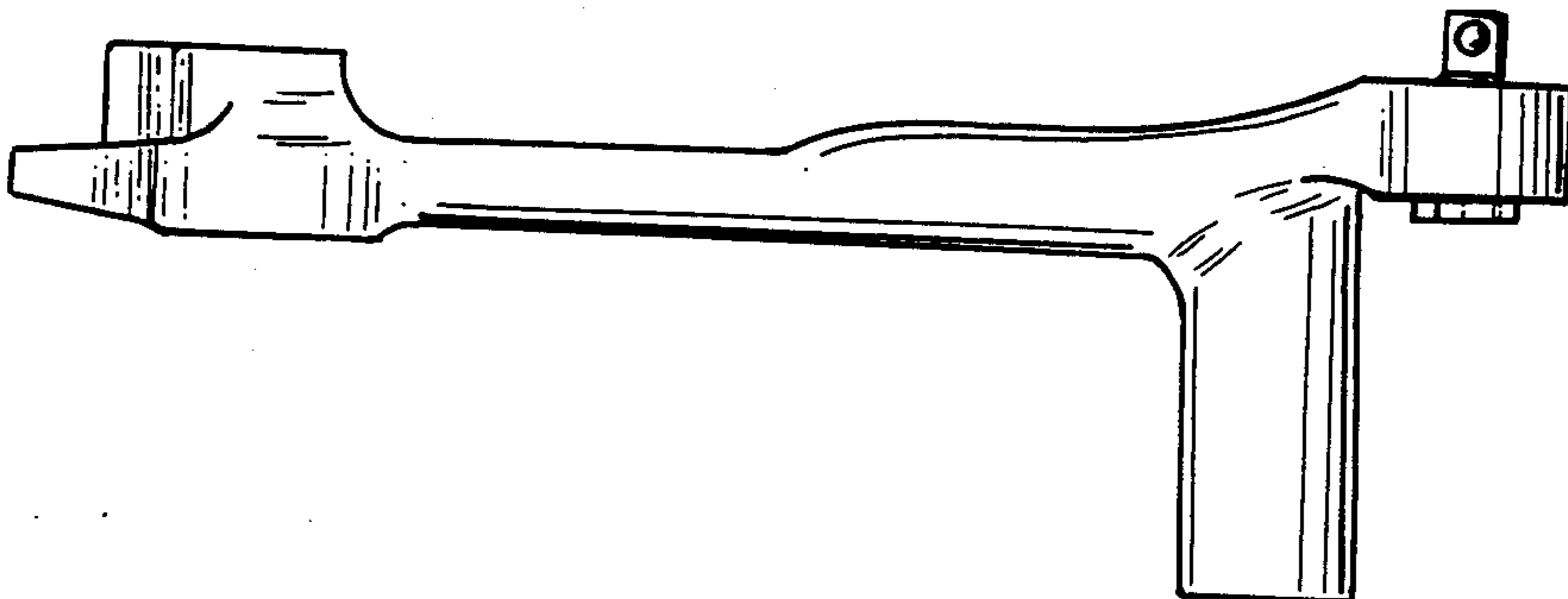

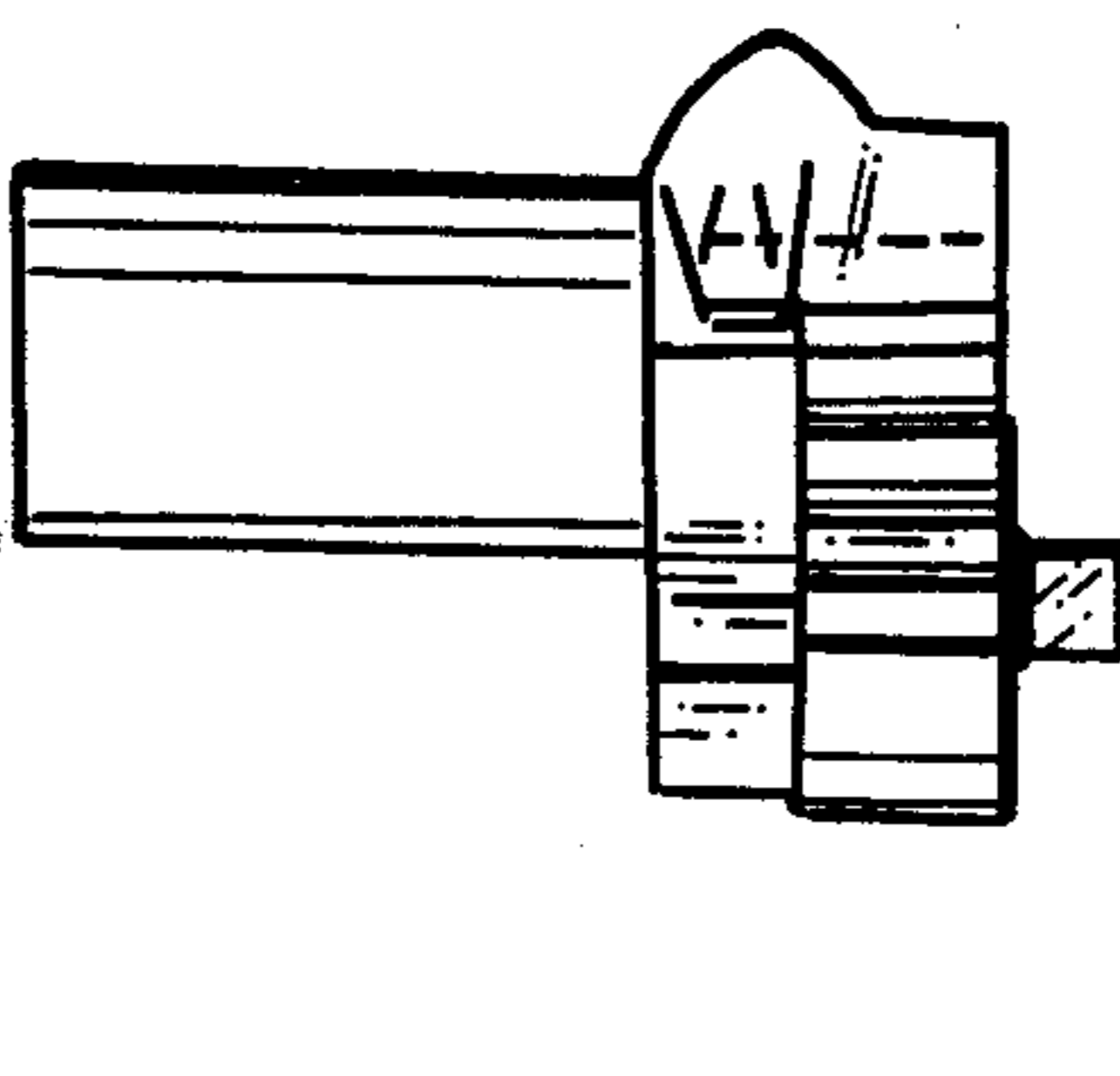
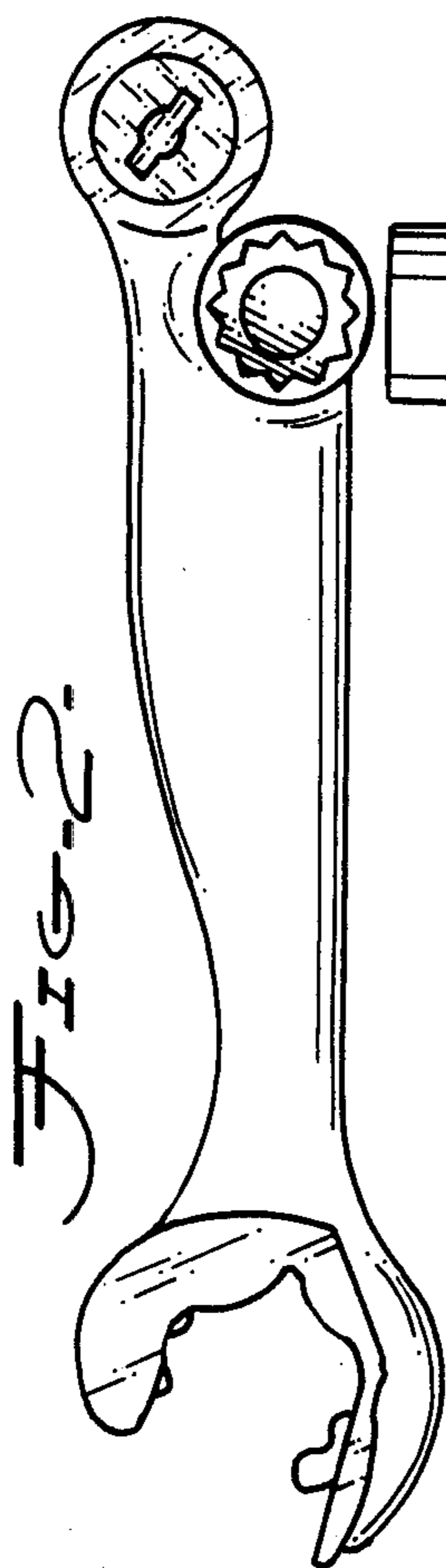
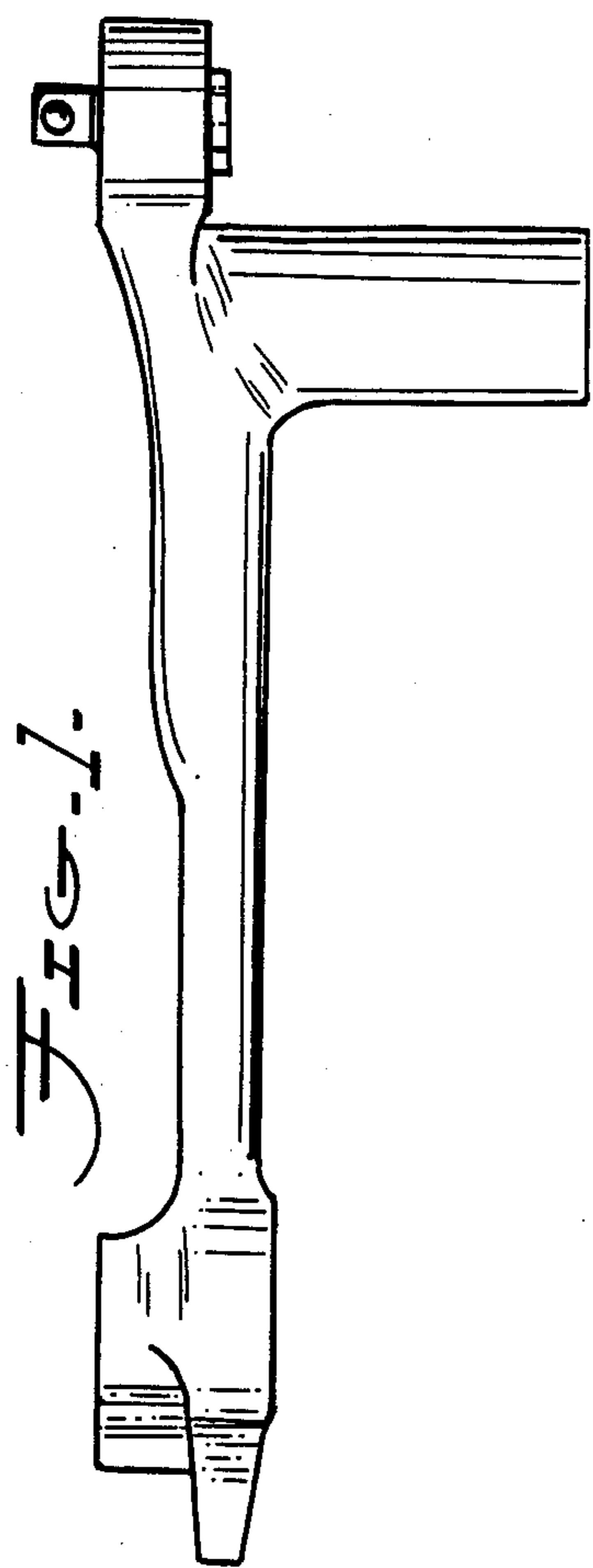

FIG. 5.

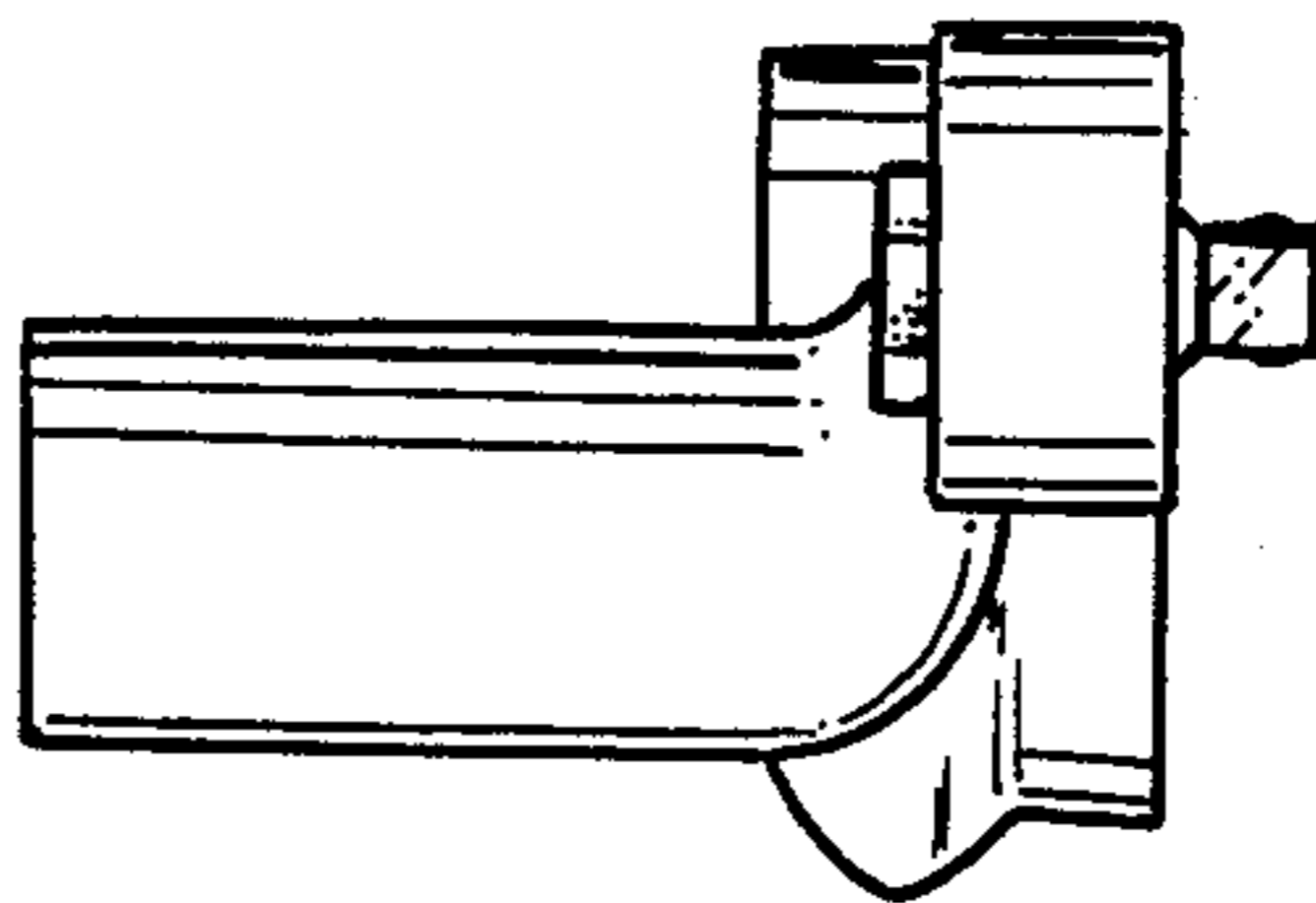

FIG. 3.

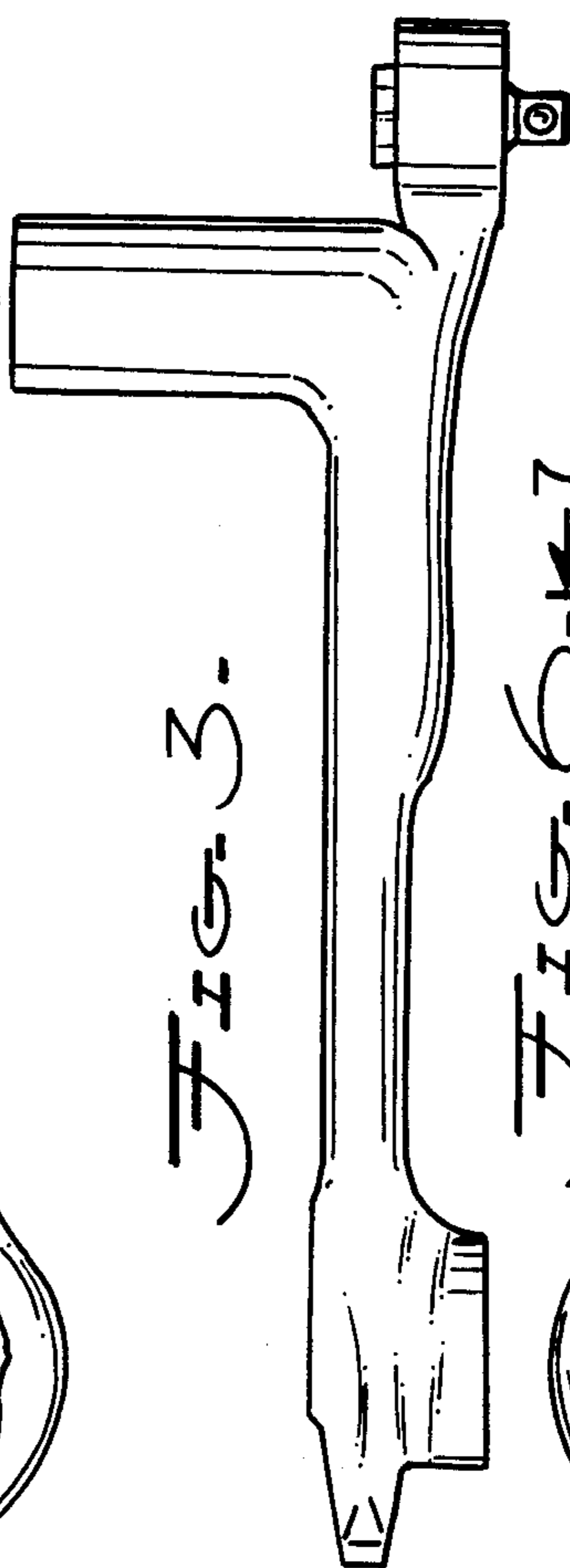

FIG. 6-K-7

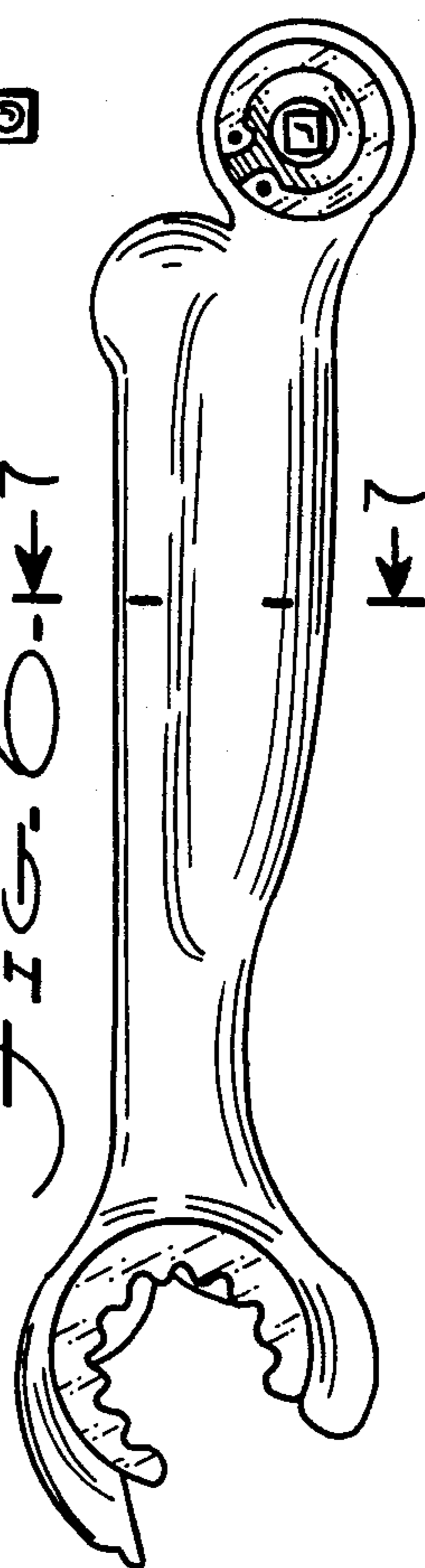

FIG. 7.

