

[54] GUITAR HEAD

[75] Inventor: Grover G. Fields, Stanton, Calif.

[73] Assignee: CBS Inc., New York, N.Y.

[**] Term: 14 Years

[21] Appl. No.: 524,786

[22] Filed: Nov. 18, 1974

[51] Int. Cl. D17-03

[52] U.S. Cl. D56/1 A

[58] Field of Search D56/1 R, 1 A; 84/267, 84/293

[56] References Cited

U.S. PATENT DOCUMENTS

D. 28,340 3/1898 Baehr D56/1 A
D. 164,227 8/1951 Fender D56/1 A

OTHER PUBLICATIONS

"6 New Guitars, 10 Exciting Custom Colors from Gibson" Flyer recv'd., U.S. Pat. Ofc. 12-22-64, p. with

Heading Firebird Guitars to Caption Below Photo, Top Thunderbird Bass Guitar Head.

Grossman Music Corp., Cleveland, Ohio, Cat. 68, c '67, Kay Guitars Section, "Kay Instruments 1967-1968 Edition," p. G, Items (F), Nos. K683 & K682.

Primary Examiner—Joel Stearman

Assistant Examiner—J. Corrigan

Attorney, Agent, or Firm—Richard L. Gausewitz

[57] CLAIM

An ornamental design for a guitar head, substantially as shown and described.

DESCRIPTION

FIG. 1 is a front, partial top and partial right side perspective view of a guitar head showing my new design; FIG. 2 is a left side elevational view; FIG. 3 is a front elevational view; FIG. 4 is a right side elevational view; FIG. 5 is a rear elevational view; FIG. 6 is a bottom plan view; and FIG. 7 is a top plan view.

The characteristic feature of my design is the configuration of the guitar head without the hardware.

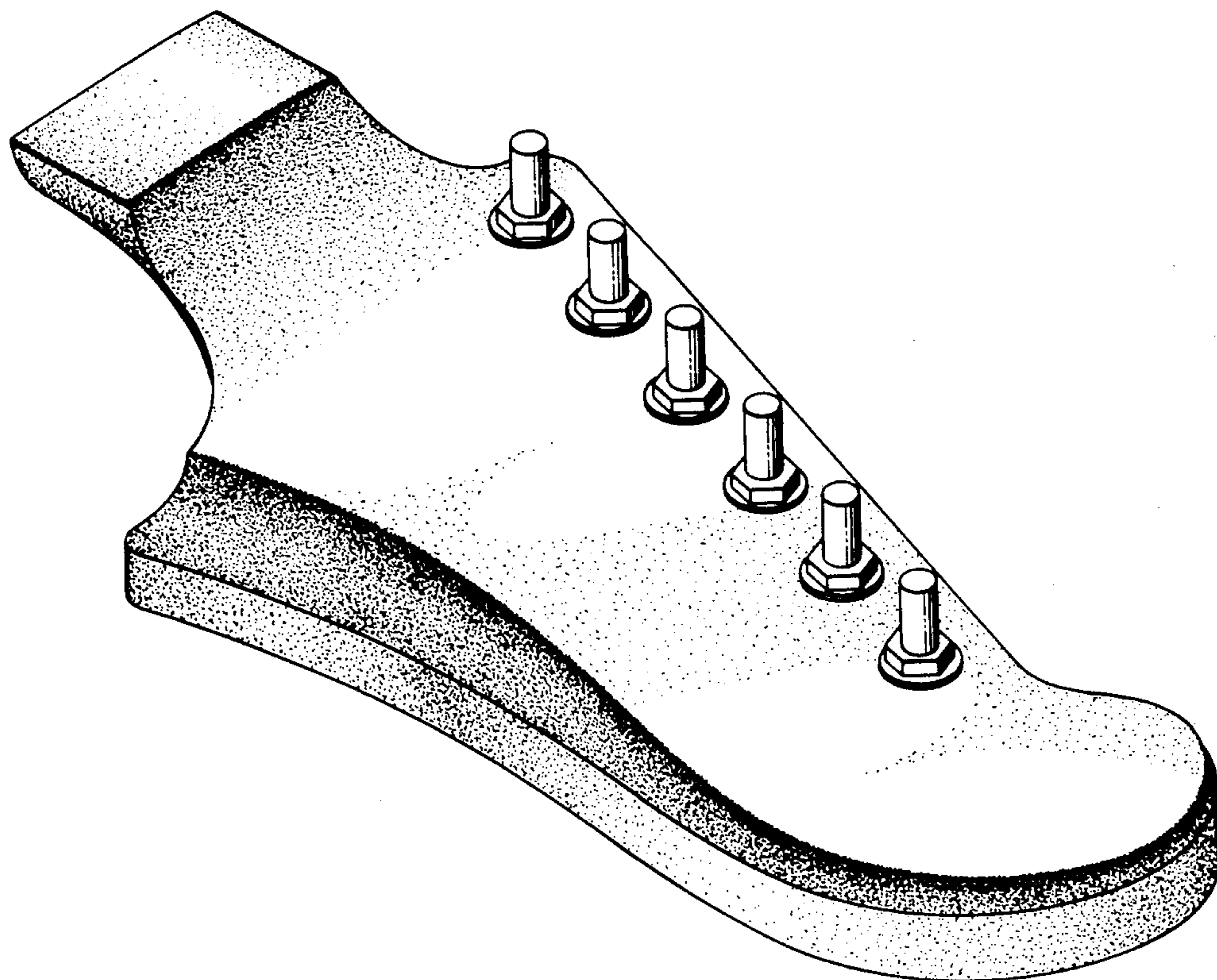

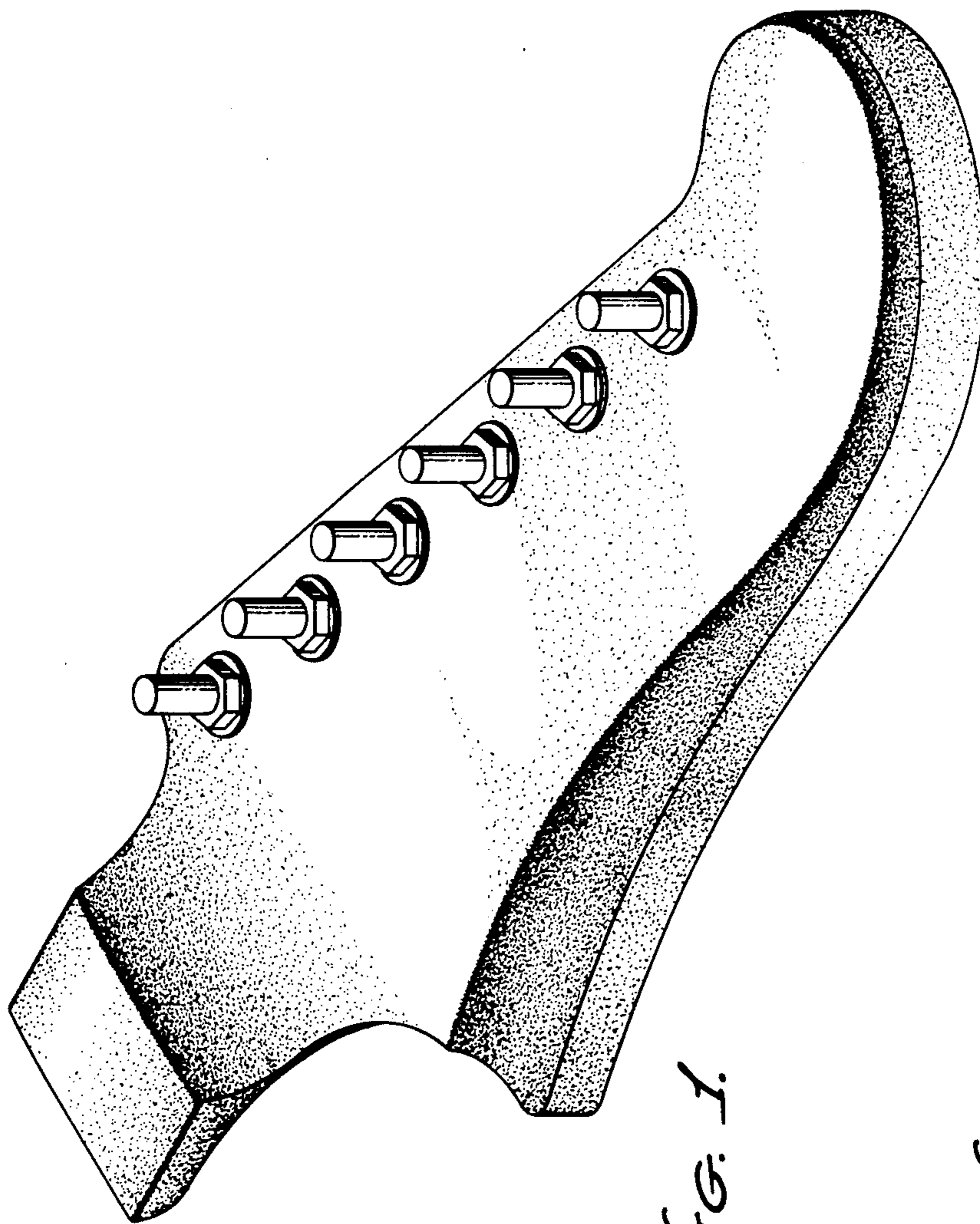

FIG. 1.

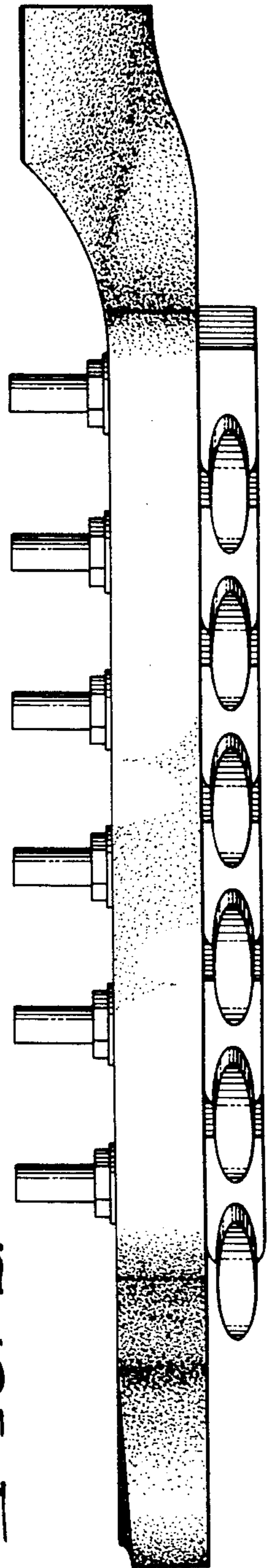
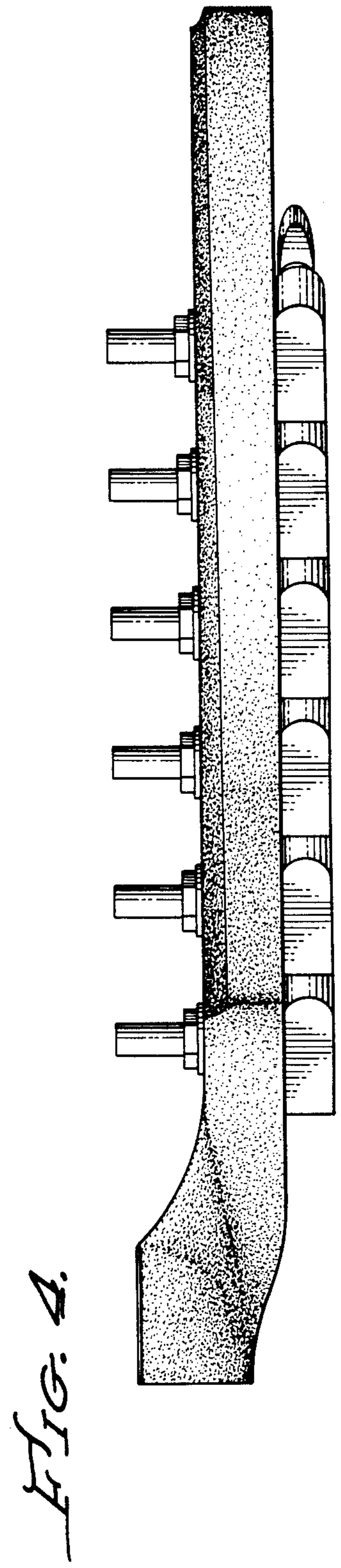
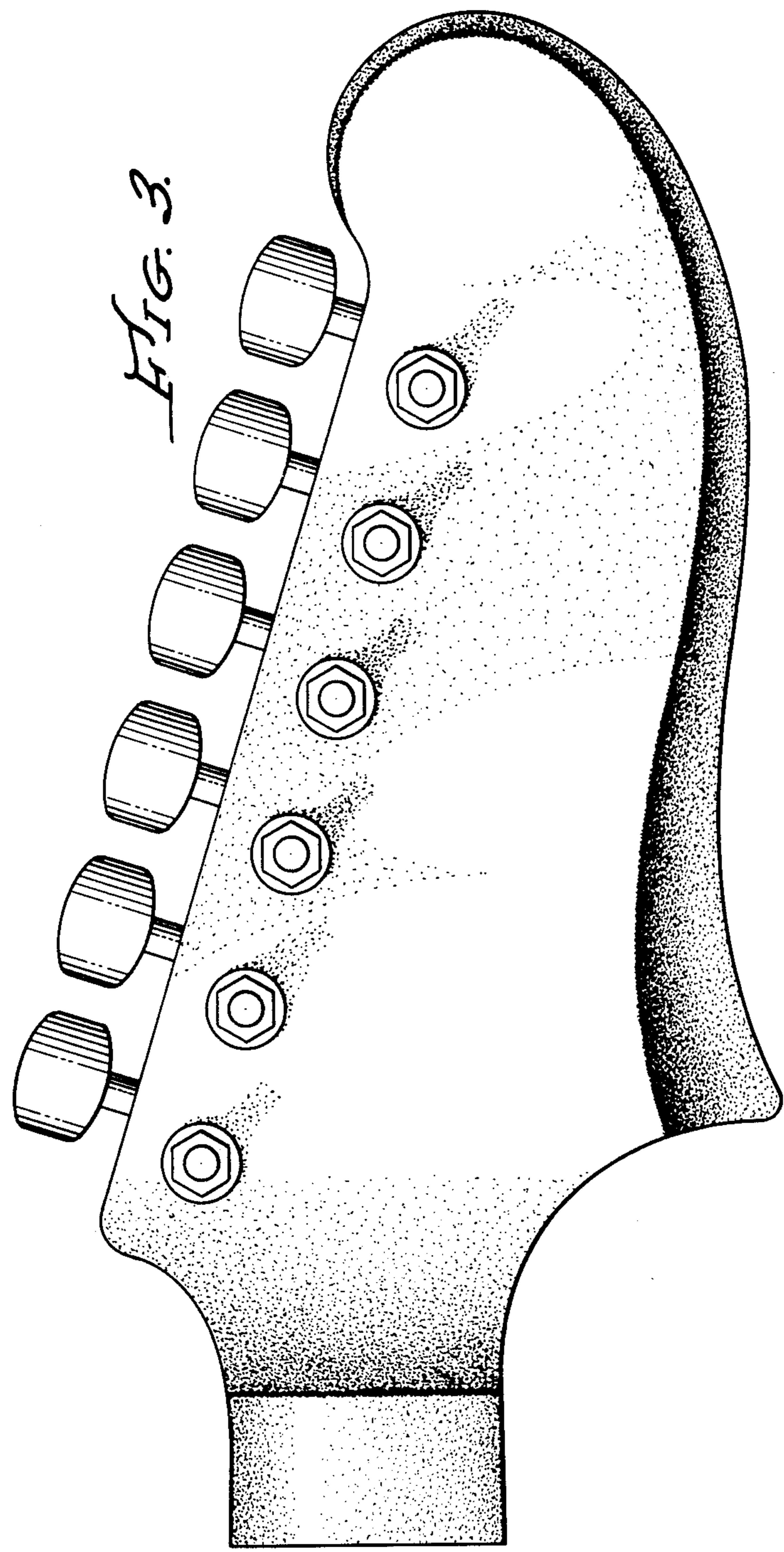

FIG. 2.



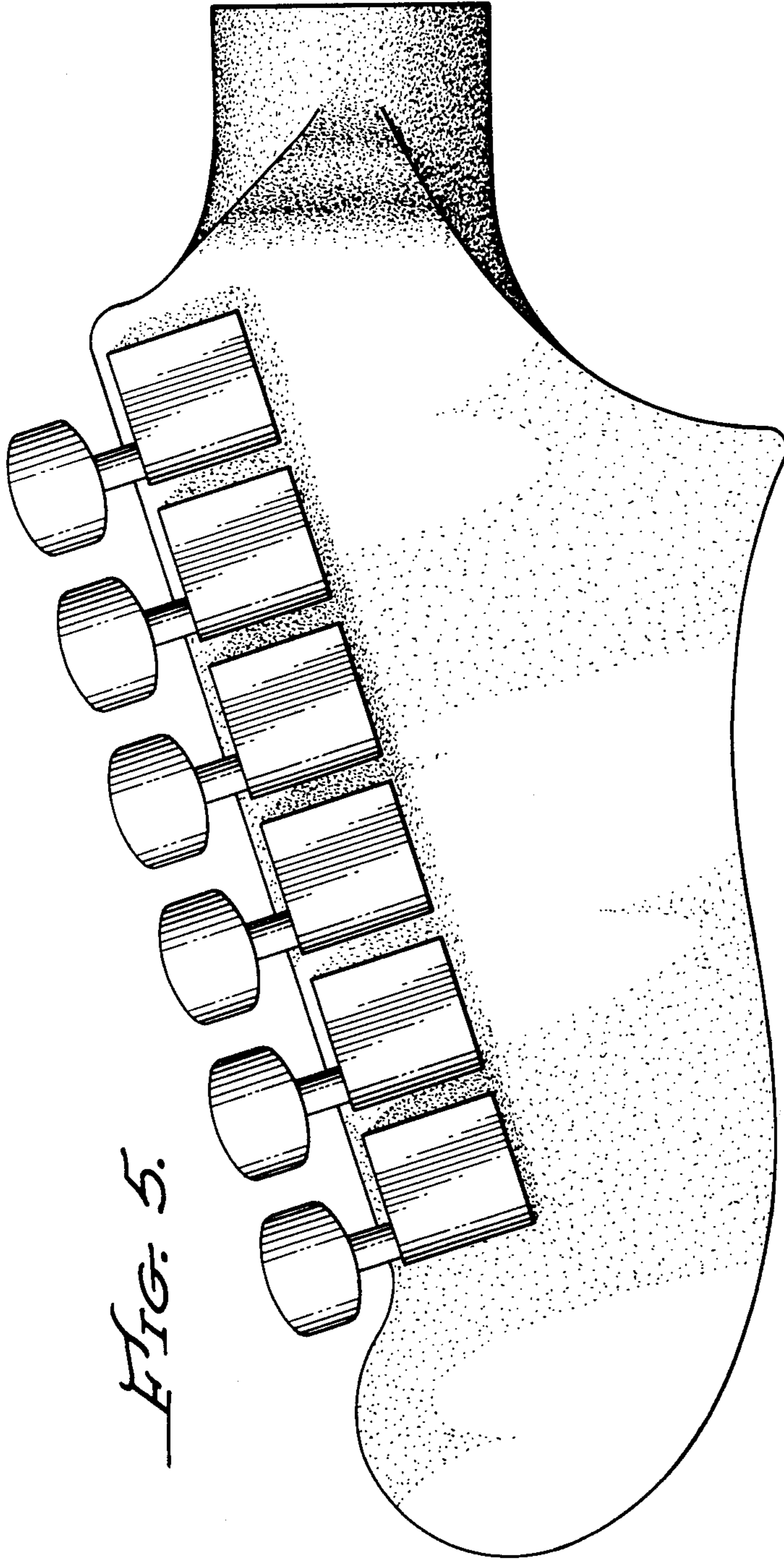

FIG. 5.

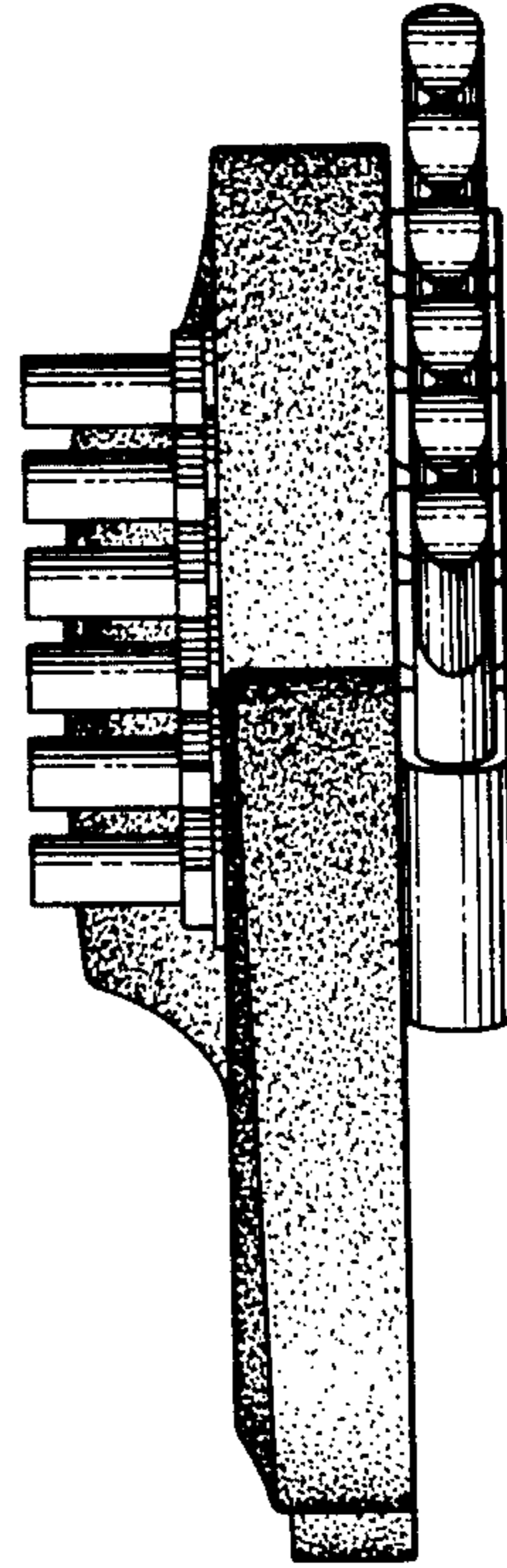

FIG. 7.

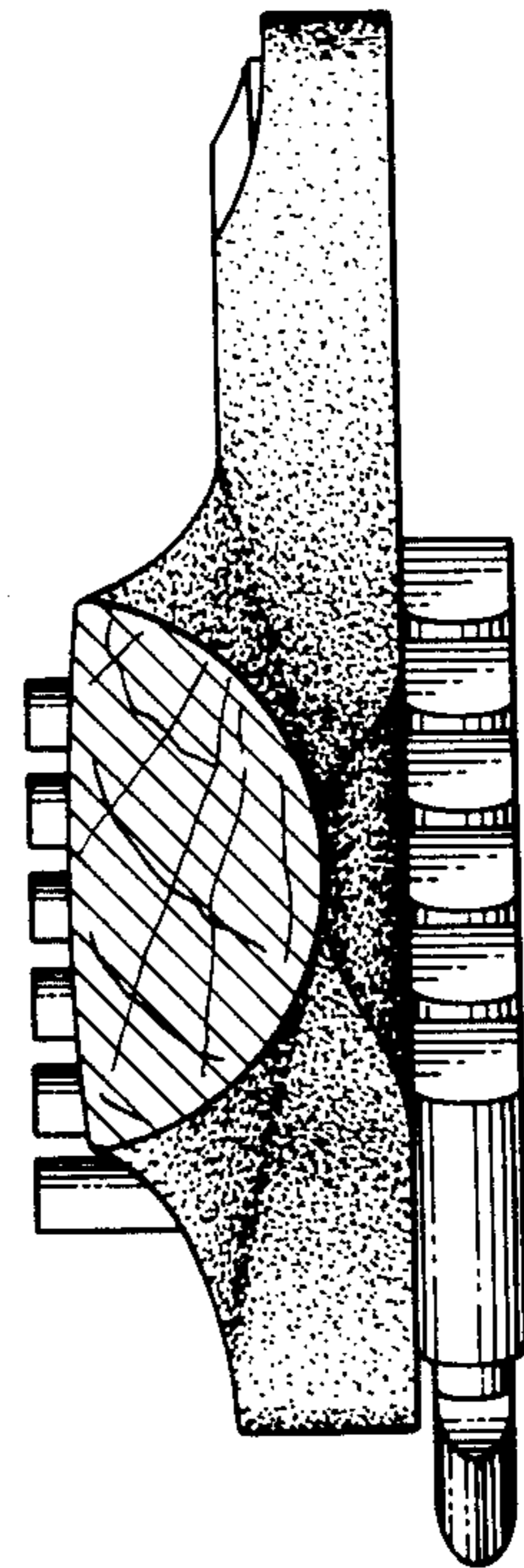

FIG. 6.