

[54] DICTATION MACHINE OR SIMILAR ARTICLE

[75] Inventors: Arthur J. Pulos, Fayetteville; Michael Cridland, Manlius; Joseph Moro, Ithaca, all of N.Y.

[73] Assignee: Dictaphone Corporation, Rye, N.Y.

[**] Term: 14 Years

[21] Appl. No.: 624,459

[22] Filed: Oct. 21, 1975

[51] Int. Cl. D14-01

[52] U.S. Cl. D14/3

[58] Field of Search D26/14 B; 274/11 R, 274/2, 11 E; D56/4 B; 360/79, 107, 101; D14/3, 71

[56] References Cited

U.S. PATENT DOCUMENTS

- D. 224,712 9/1972 Van der Poel D26/14 B
- D. 228,662 10/1973 Sakuma D26/14 B
- D. 237,507 11/1975 Pulos et al. D26/14 B

Primary Examiner—Bernard Ansher
Attorney, Agent, or Firm—Arthur V. Smith

[57] CLAIM

The ornamental design for a dictation machine or similar article, as shown.

DESCRIPTION

FIG. 1 is a front perspective view of a dictation machine or similar article, showing our new design; FIG. 2 is a rear perspective view thereof; FIG. 3 is a top plan view thereof; FIG. 4 is a front end view thereof; FIG. 5 is a rear view thereof; FIG. 6 is a left side elevational view thereof; and FIG. 7 is a right side elevational view thereof.

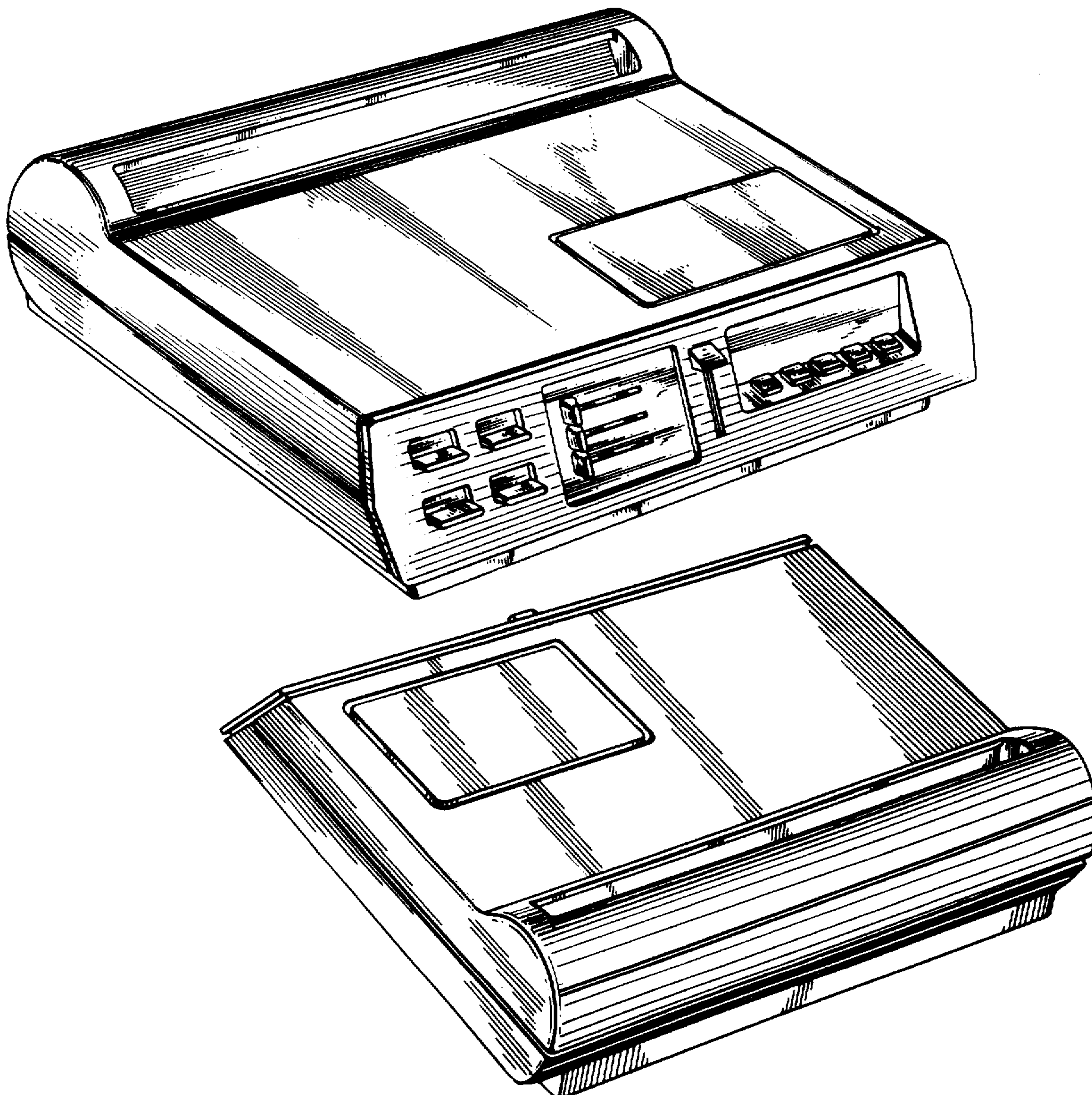

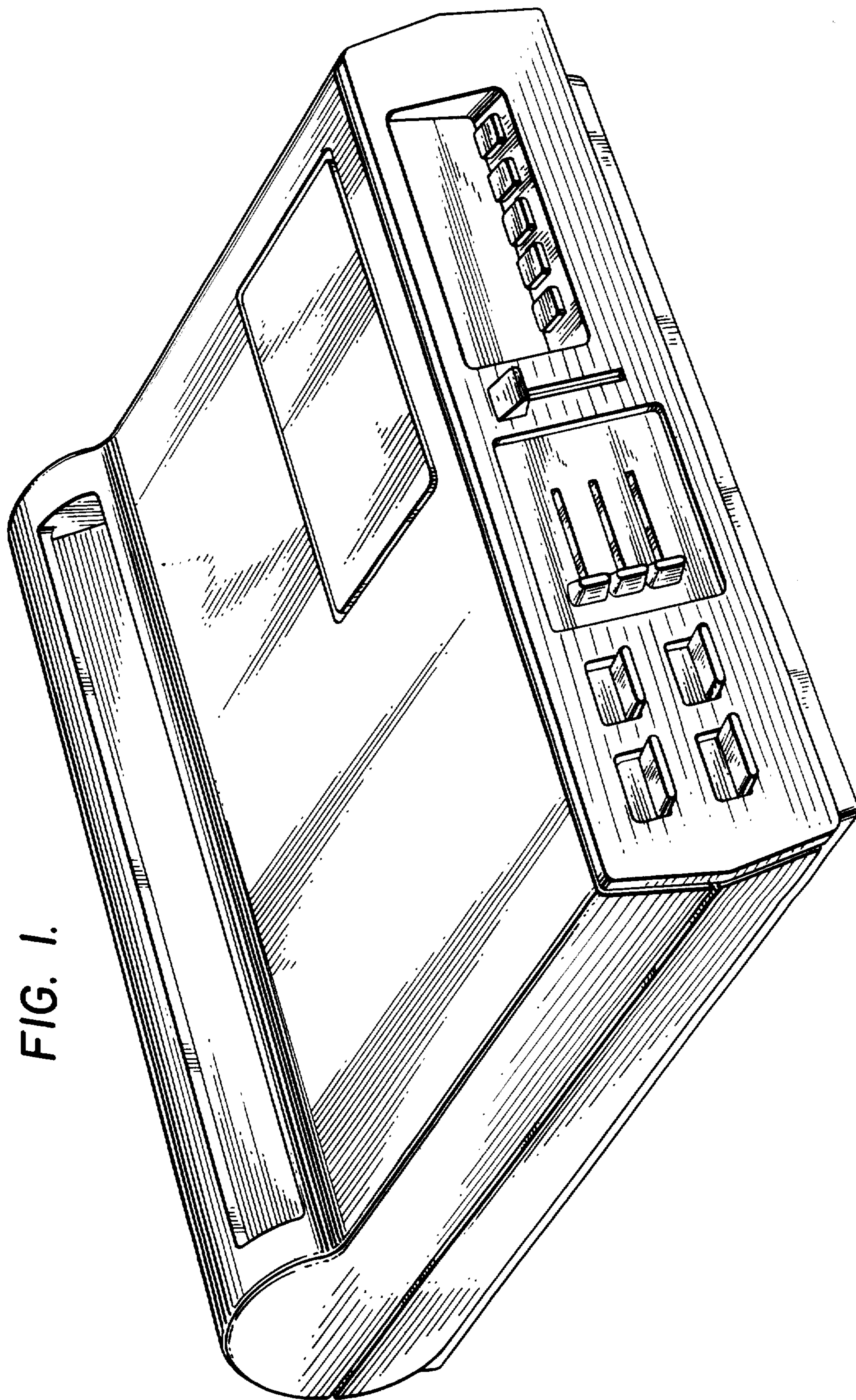

FIG. 1.

FIG. 2.

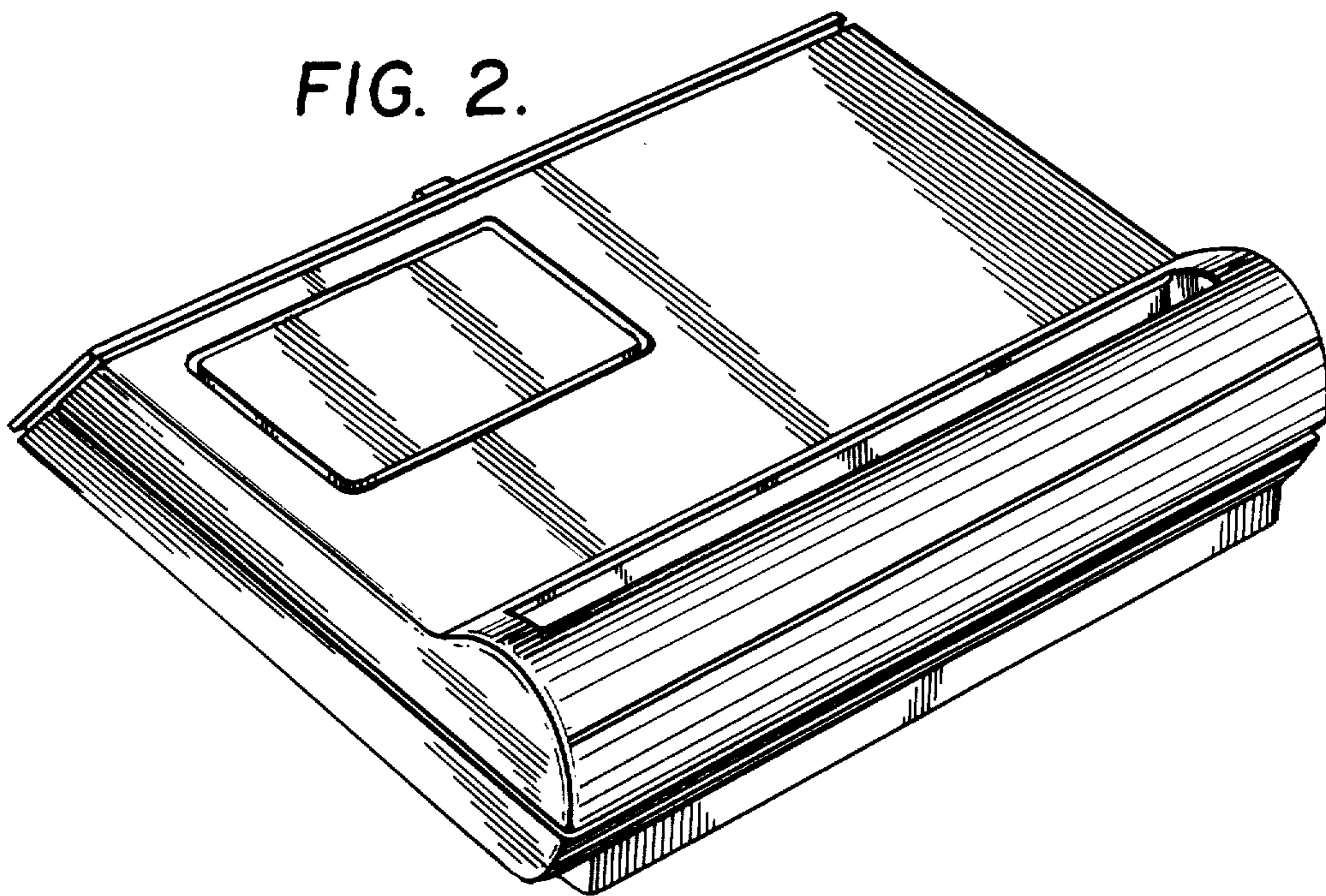

FIG. 3.

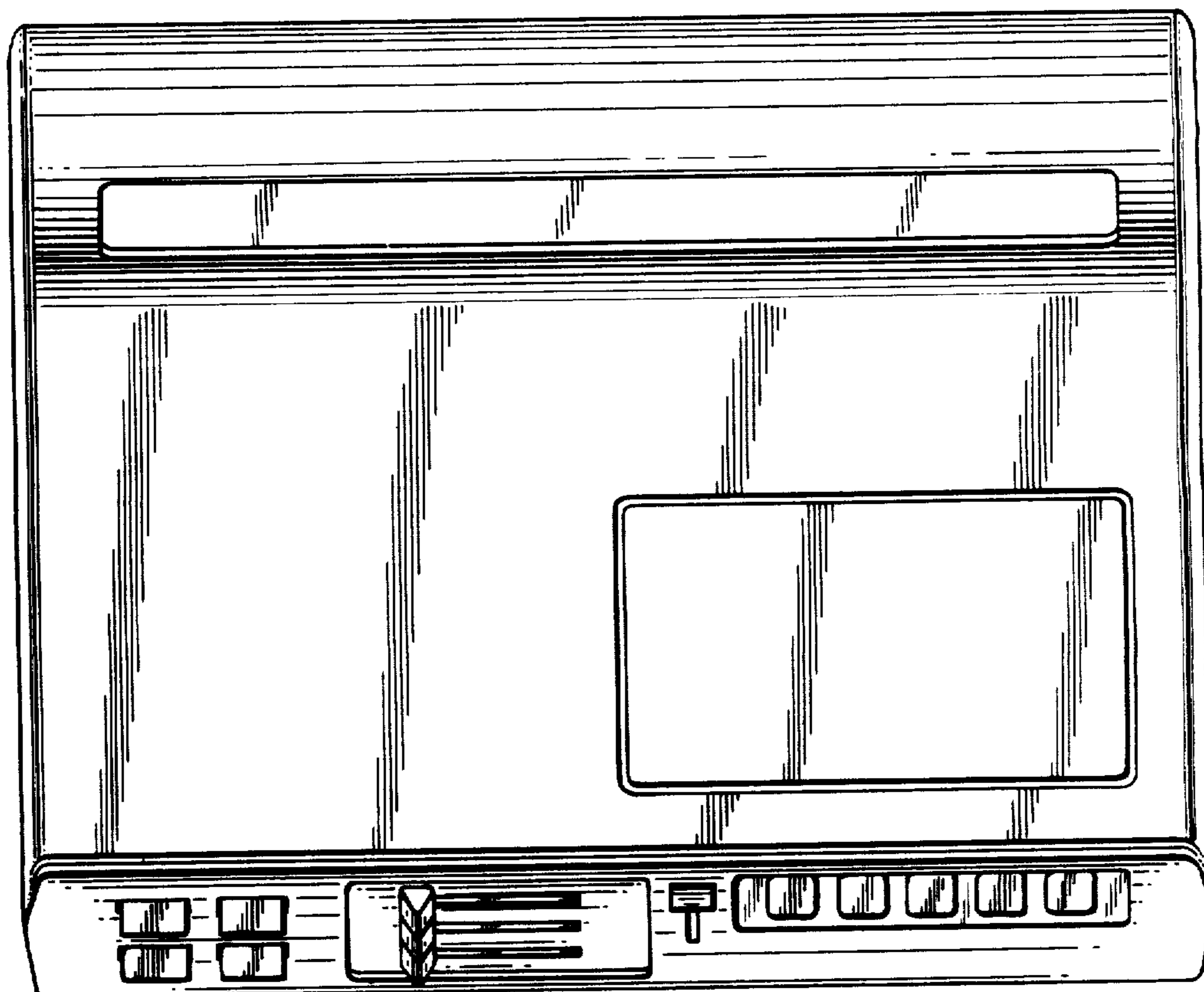

FIG. 4.

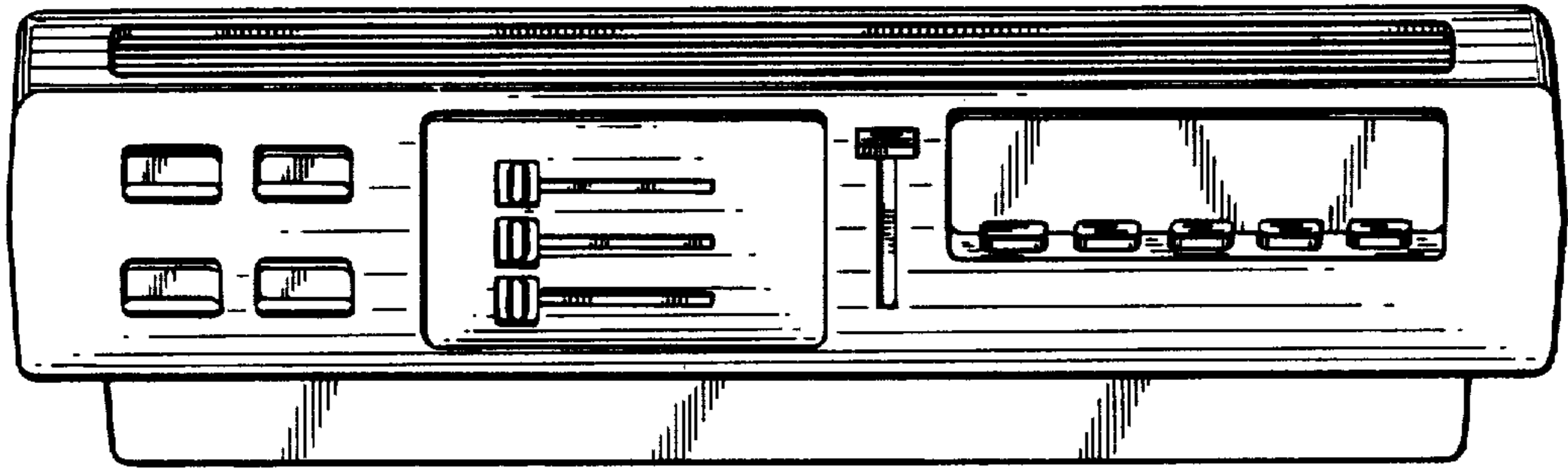

FIG. 5.

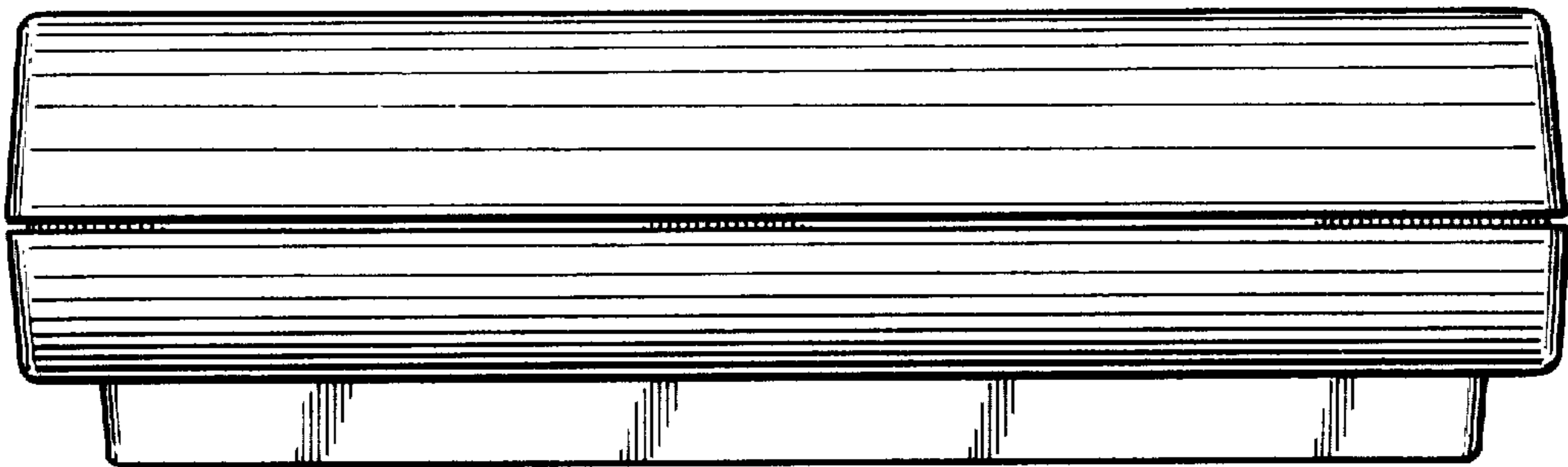

FIG. 6.

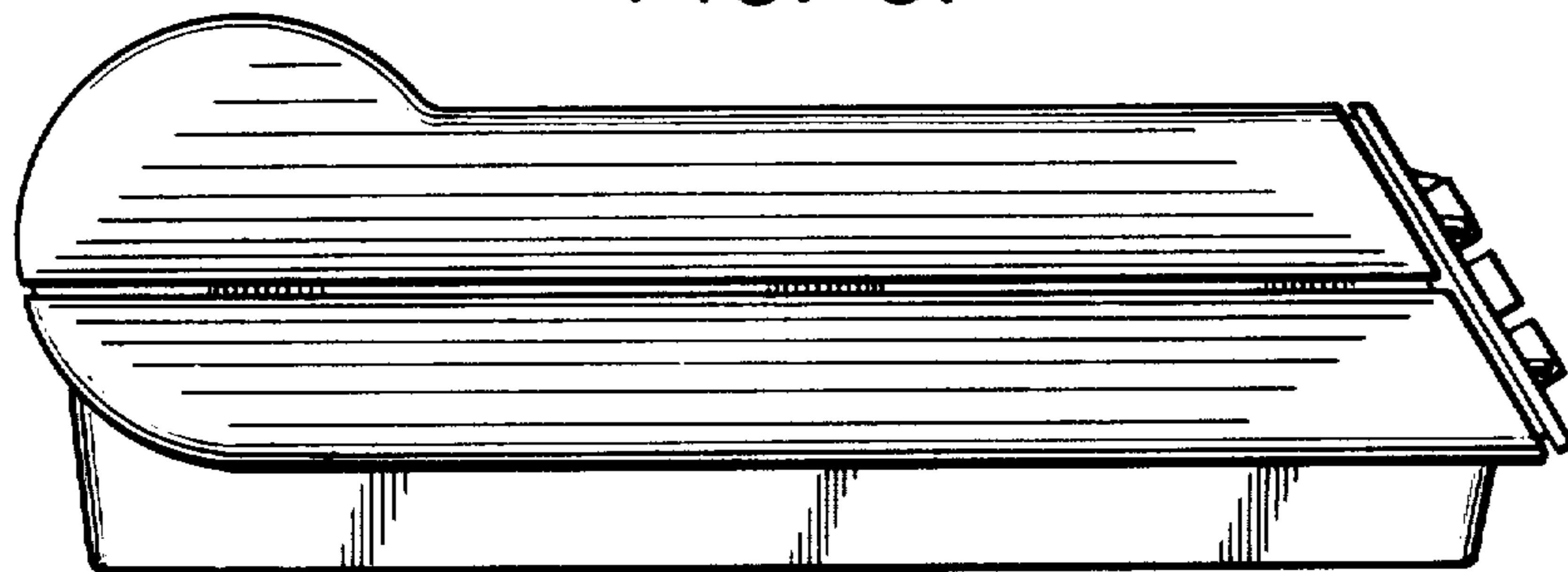

FIG. 7.

