

[54] SAILBOAT

[76] Inventor: Rudolf Rudiger, 800 Andersen Drive, San Rafael, Calif. 94901

[**] Term: 14 Years

[21] Appl. No.: 723,741

[22] Filed: Sept. 16, 1976

[51] Int. Cl. D12-06

[52] U.S. Cl. D12/64

[58] Field of Search D12/64, 63; 114/39

[56] References Cited

U.S. PATENT DOCUMENTS

3,173,395	3/1965	Laurent	114/39
3,304,899	2/1967	Weatherly	114/39
3,933,110	1/1976	Jamieson	114/39
D. 239,711	4/1976	Rineman	D12/64

Primary Examiner—Alan P. Douglas

Attorney, Agent, or Firm—Ernest H. McCoy

[57] CLAIM

The ornamental design for a sailboat, as shown and described.

DESCRIPTION

FIG. 1 is a right side elevational view of my new design for a sailboat;
 FIG. 2 is a left side elevational view thereof;
 FIG. 3 is a front elevational view thereof;
 FIG. 4 is a rear elevational view thereof;
 FIG. 5 is a top plan view thereof;
 FIG. 6 is a right side elevational view of a modified form of the design shown in FIG. 1;
 FIG. 7 is a left side elevational view thereof;
 FIG. 8 is a front elevational view thereof;
 FIG. 9 is a rear elevational view thereof;
 FIG. 10 is a top plan view thereof;
 FIG. 11 is a right side elevational view of a further modified form of the design shown in FIG. 1;
 FIG. 12 is a left side elevational view thereof;
 FIG. 13 is a front elevational view thereof;
 FIG. 14 is a rear elevational view thereof; and
 FIG. 15 is a top plan view thereof;

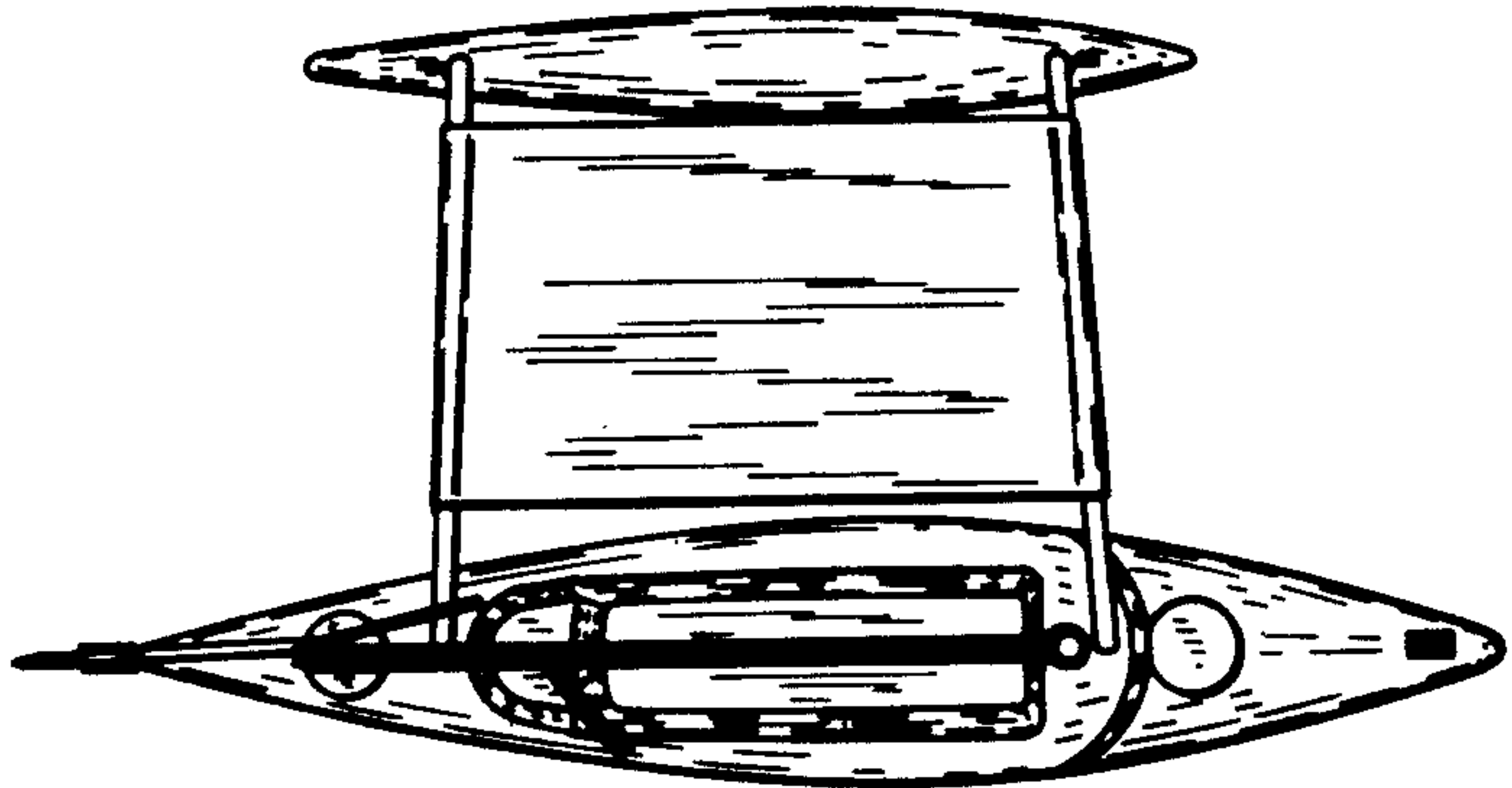
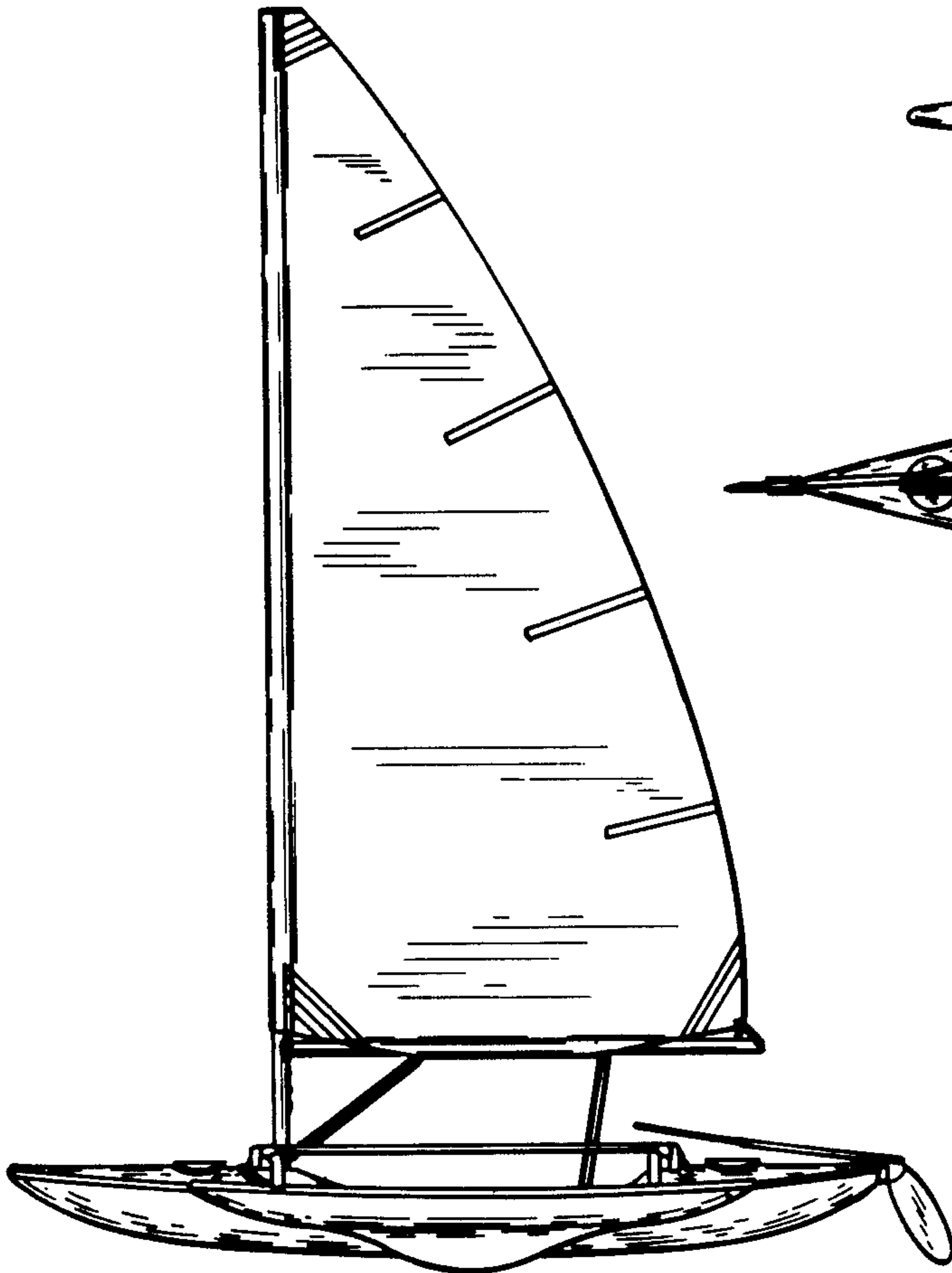

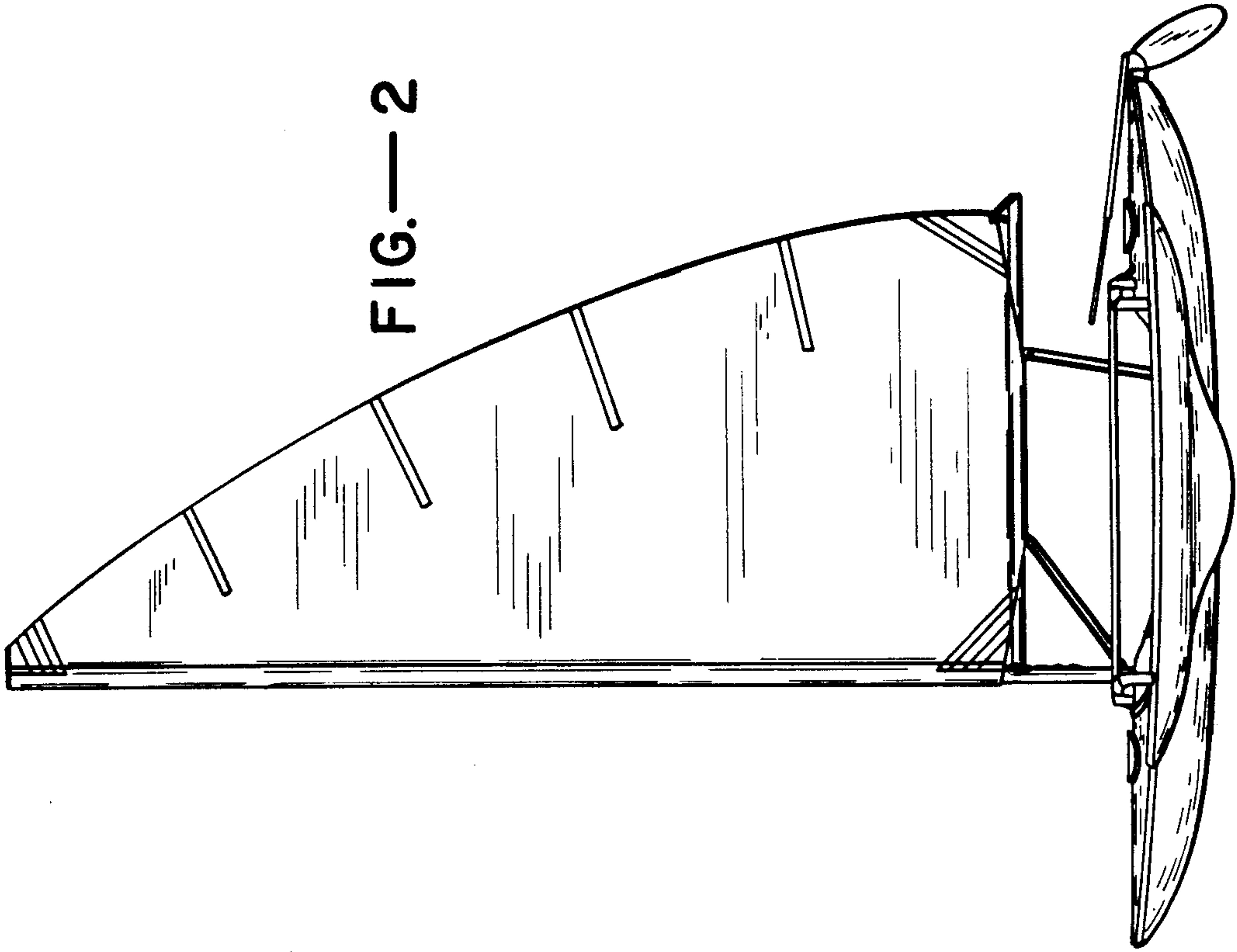

FIG.—2

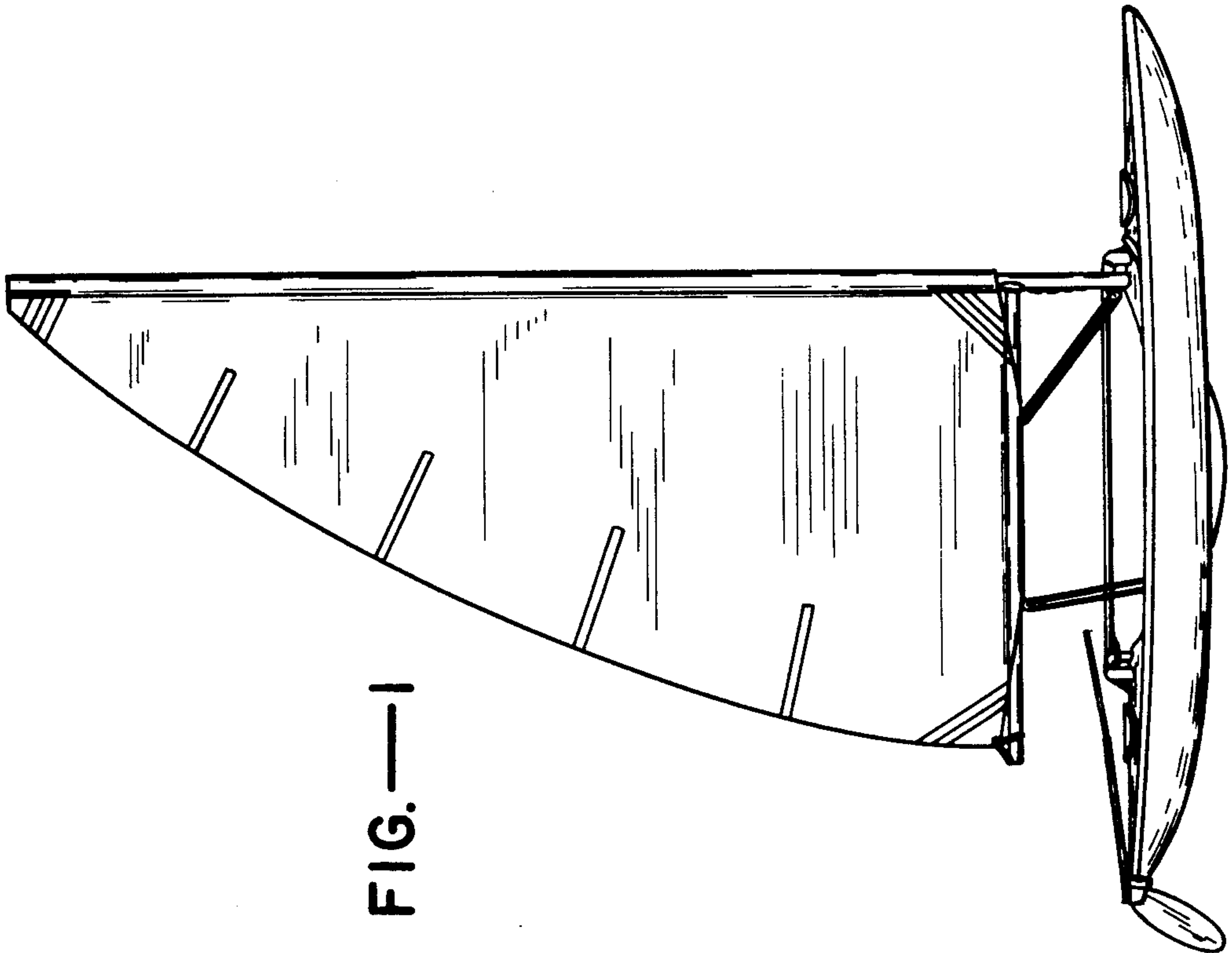

FIG.—1

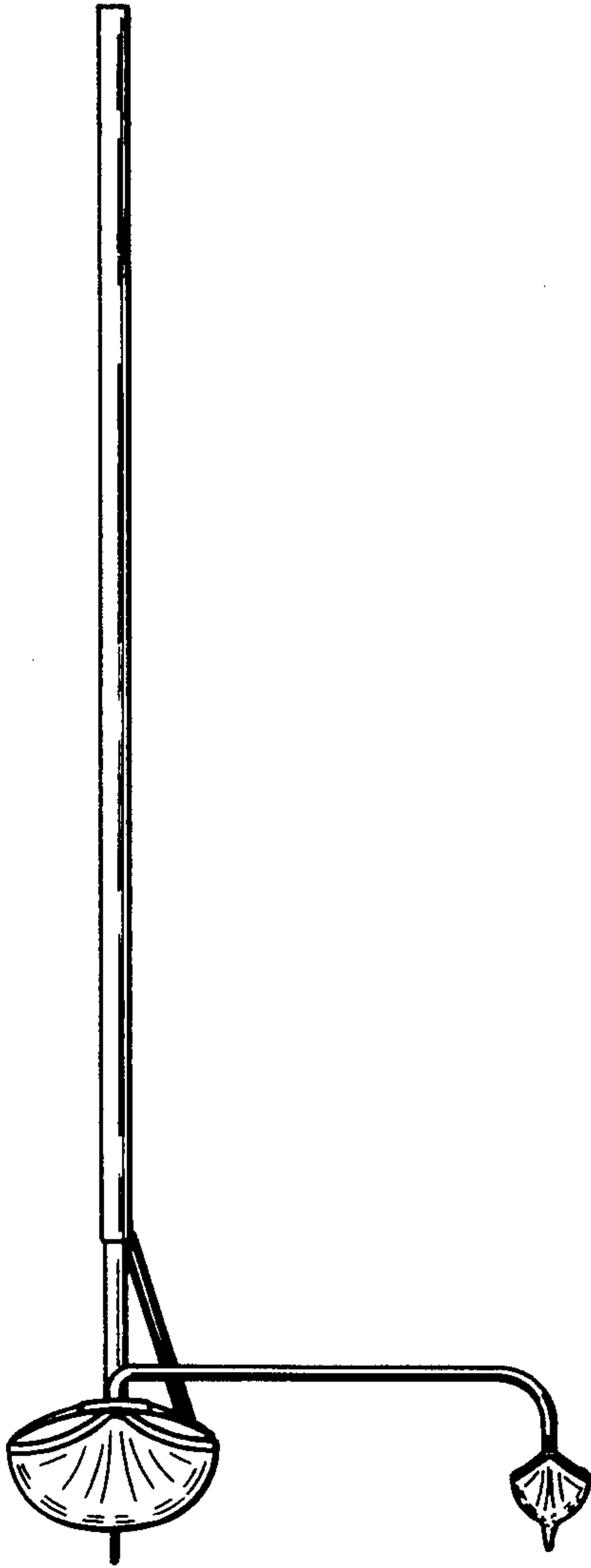

FIG. — 3

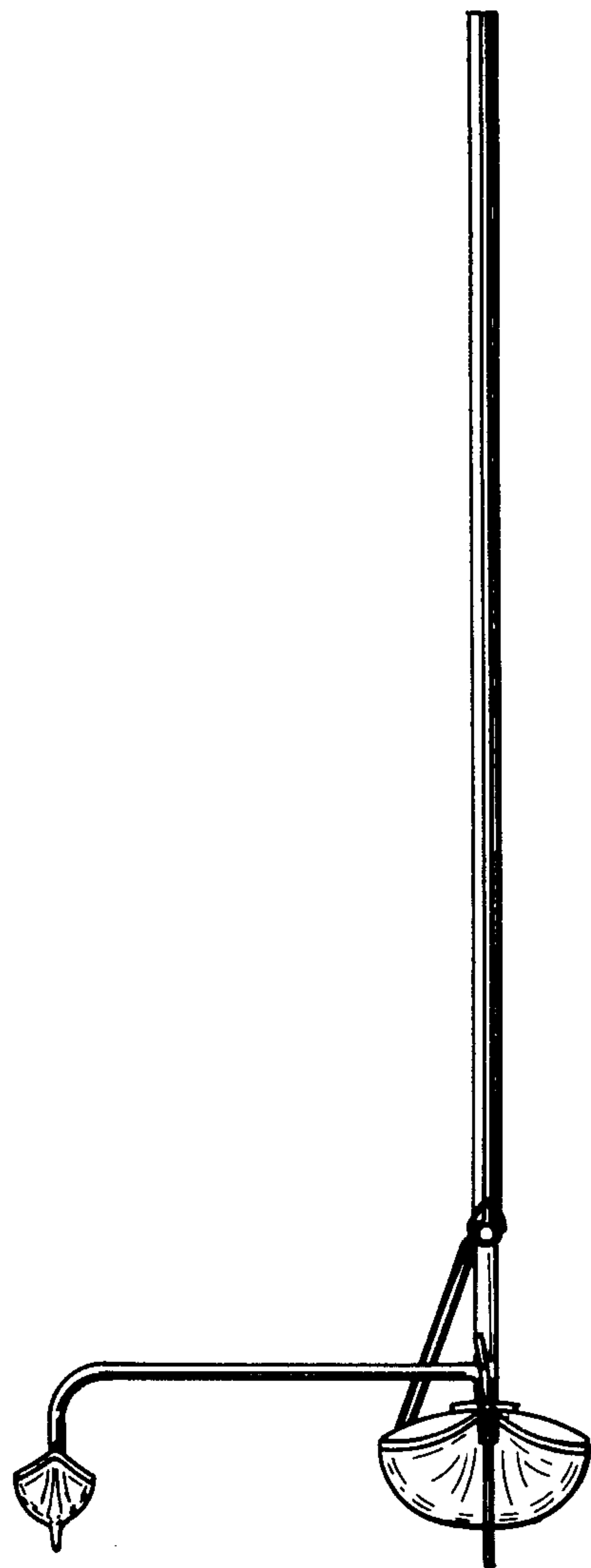

FIG. — 4

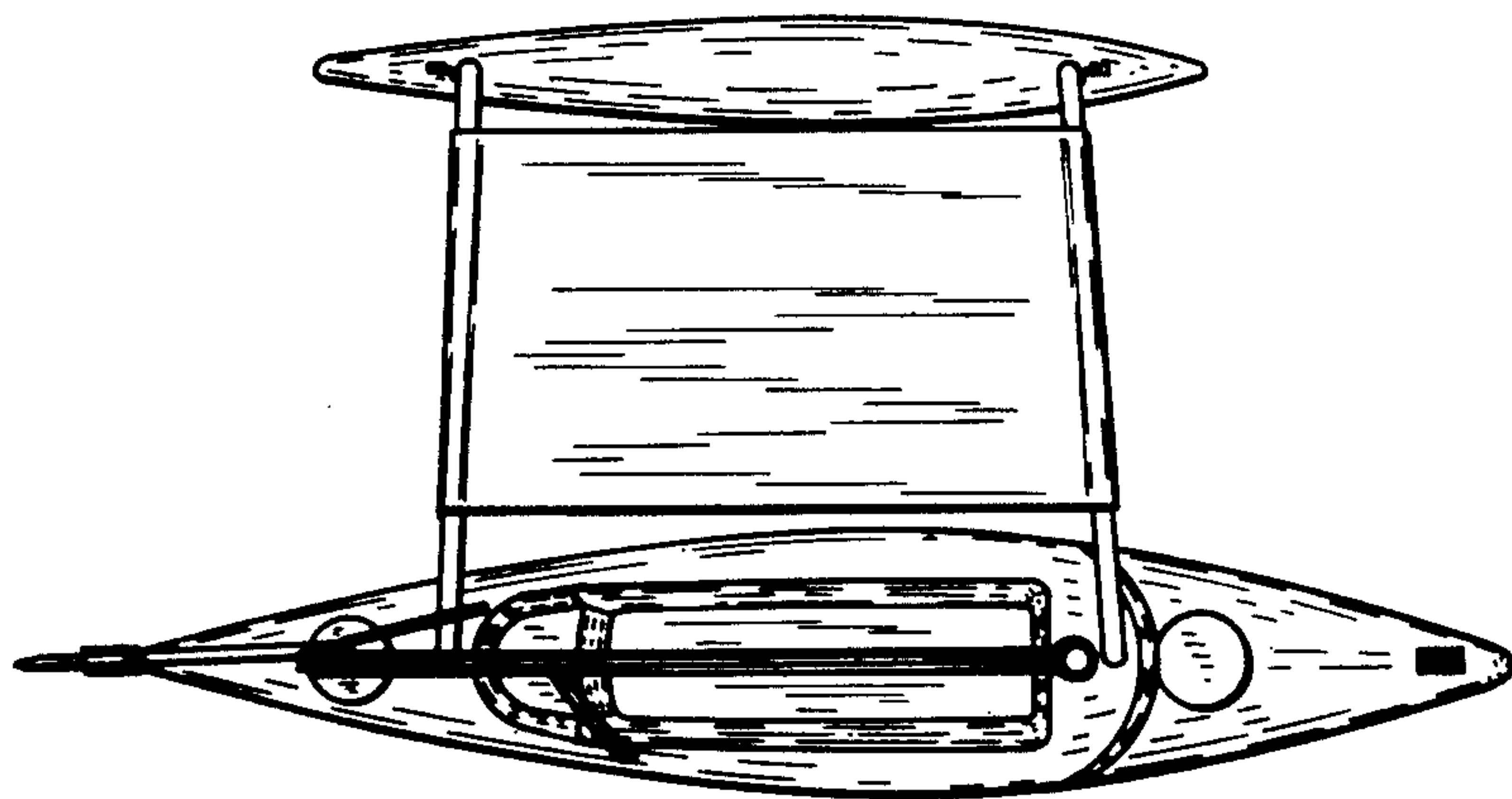

FIG. — 5

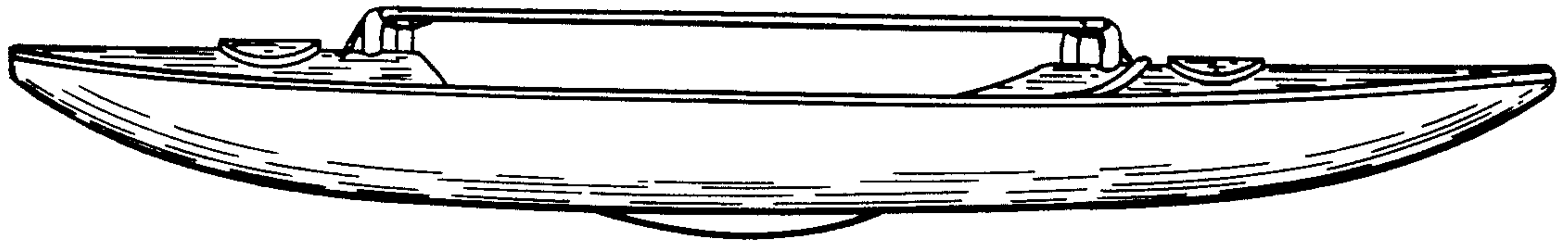

FIG. — 6



FIG. — 7

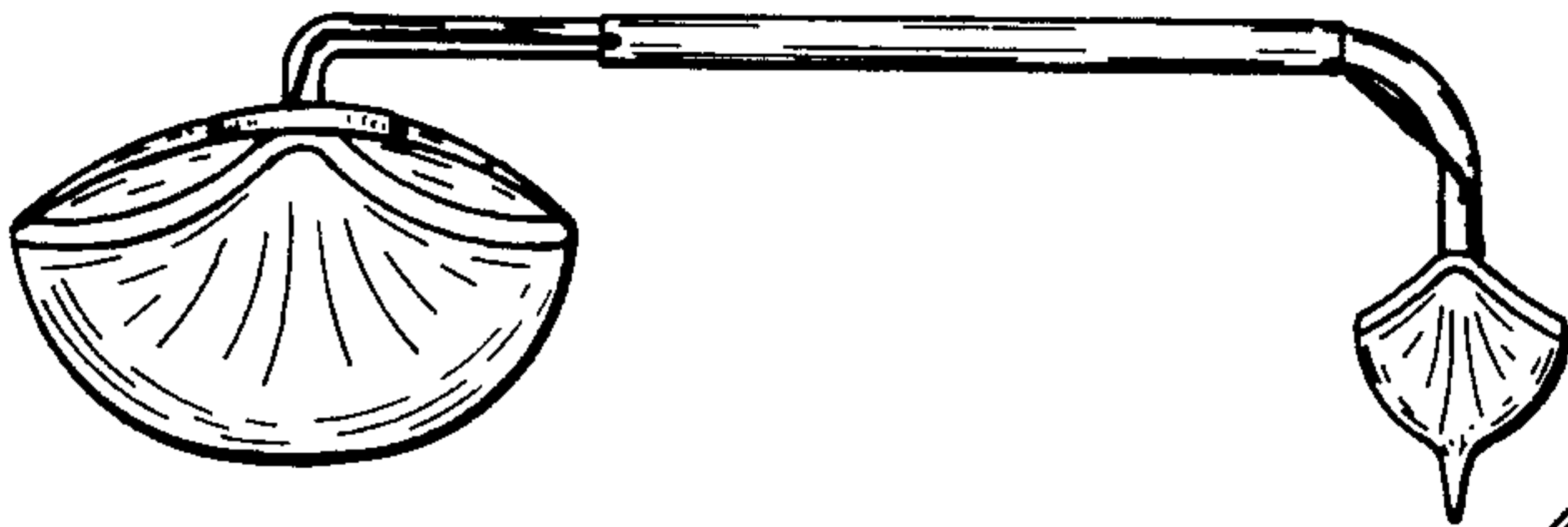

FIG. — 8

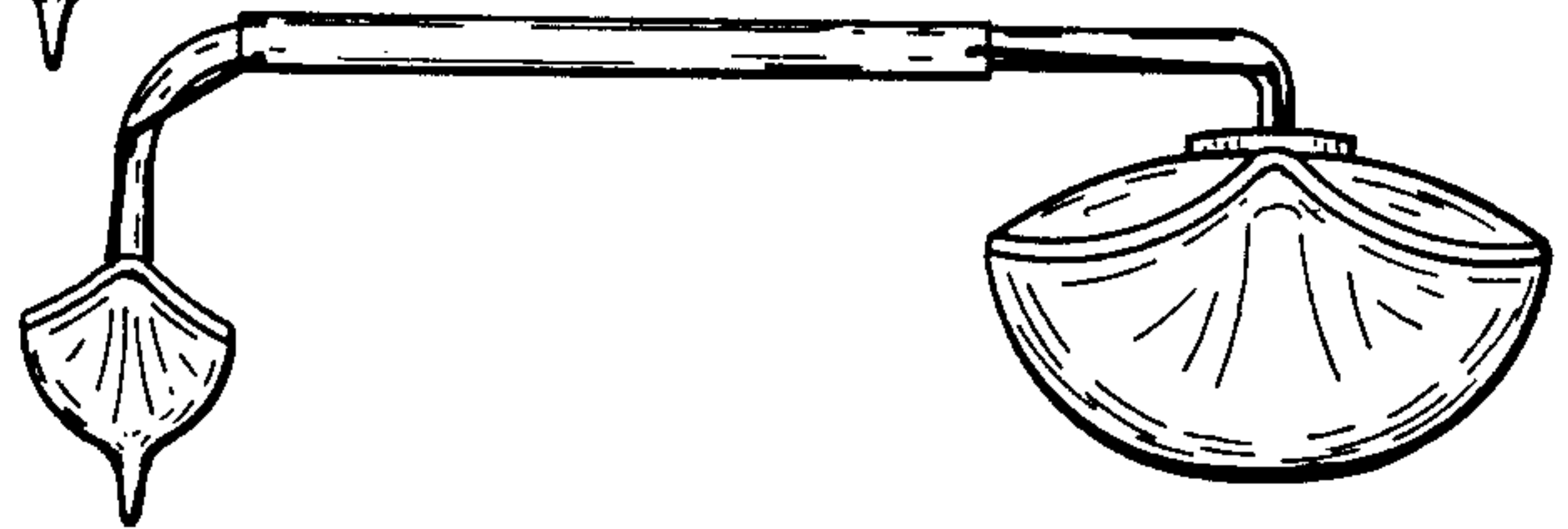

FIG. — 9

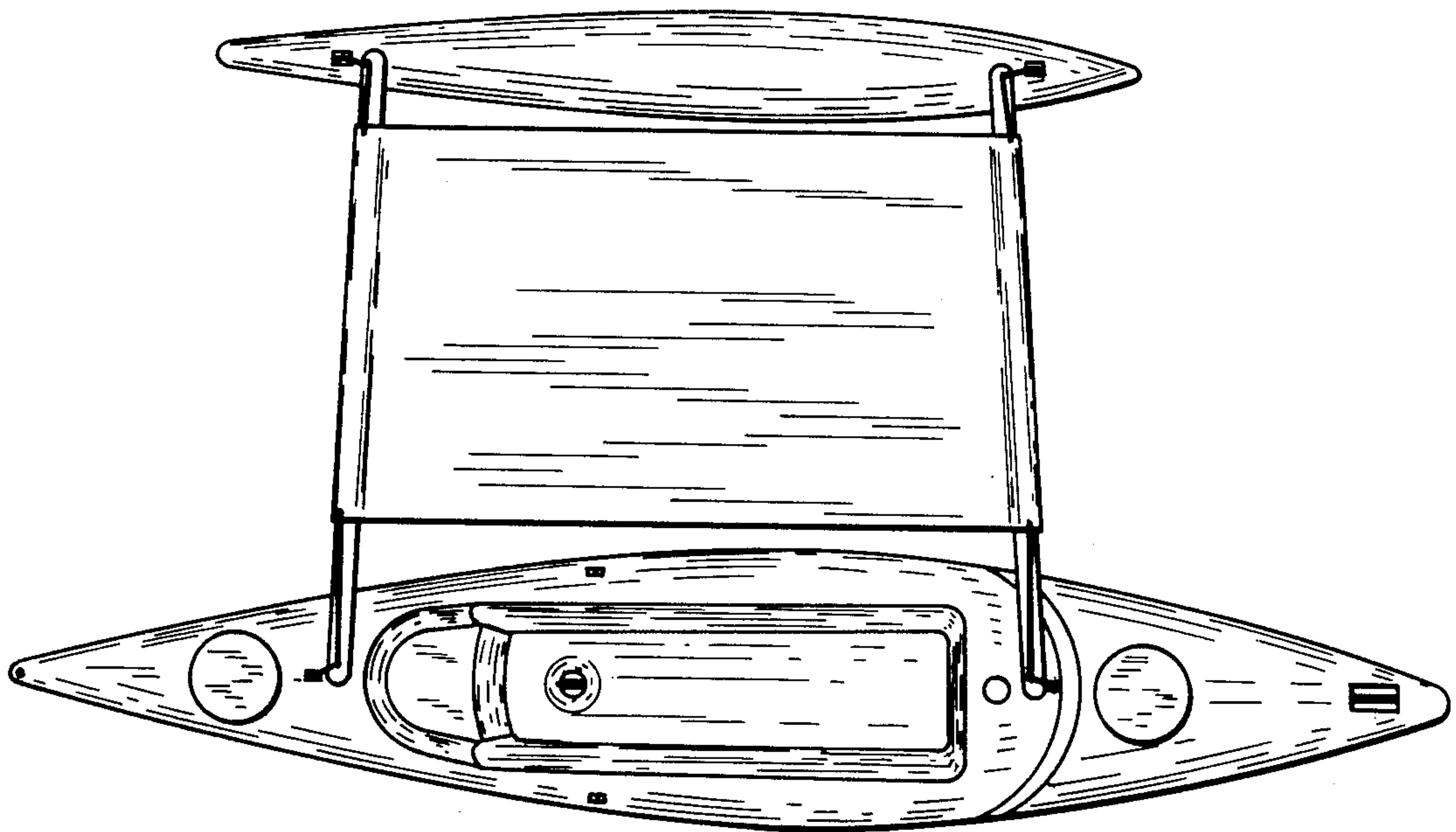

FIG. — 10

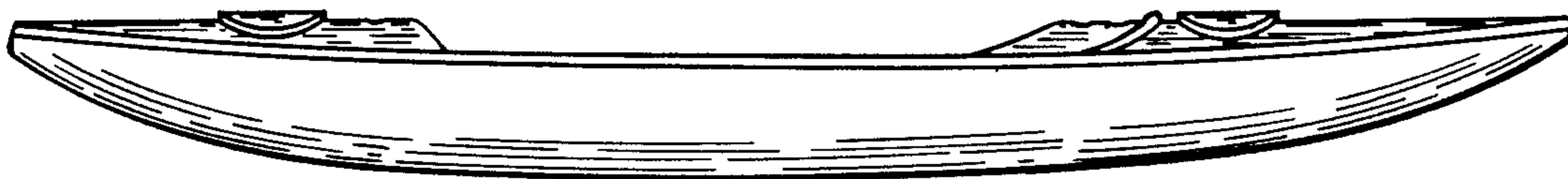

FIG. — 11

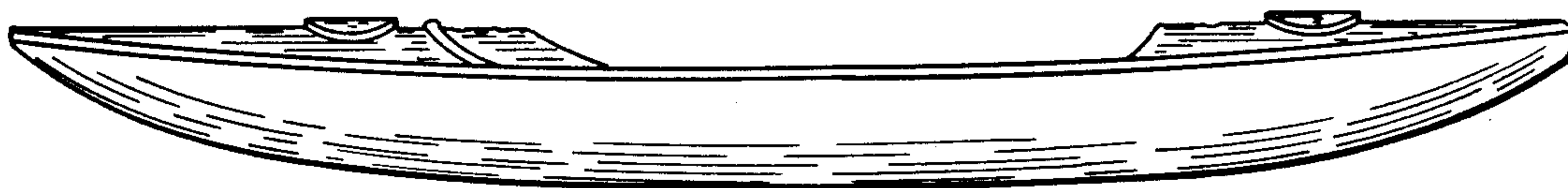

FIG. — 12

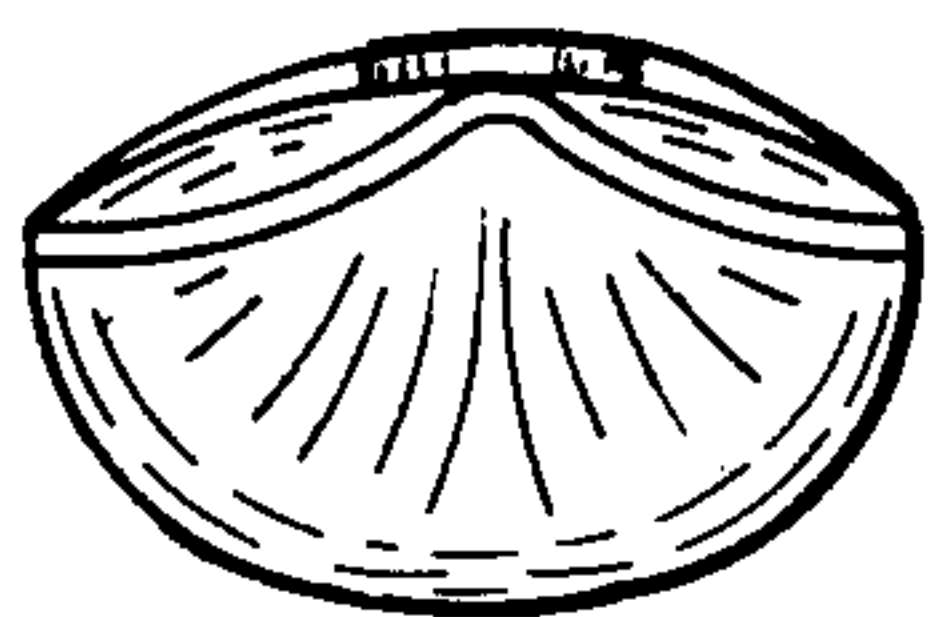

FIG. — 13



FIG. — 14

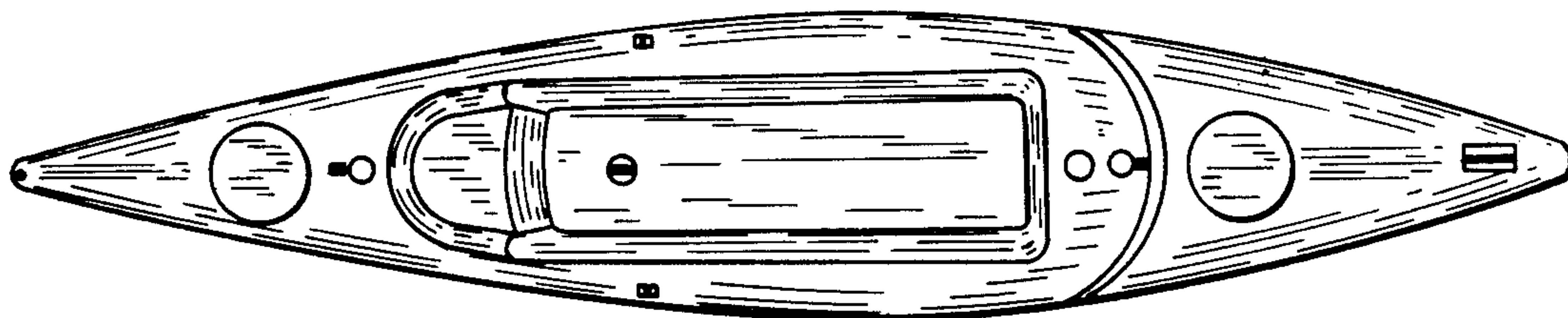

FIG. — 15