

[54] READING STAND OR THE LIKE

[76] Inventor: Joseph Daniel Brady, 7103 Inglewood Ave., Stockton, Calif. 95207

[\*\*] Term: 14 Years

[21] Appl. No.: 659,654

[22] Filed: Feb. 20, 1976

[51] Int. Cl. .... D6-99

[52] U.S. Cl. .... D6/25

[58] Field of Search ..... D6/20-31, D6/184, 85, 138, 178, 185; 281/45; 248/441; D19/91

[56] References Cited

U.S. PATENT DOCUMENTS

- 2,528,990 11/1950 Atwood ..... D19/91 X
- 2,794,695 6/1957 Heal ..... D6/178 X

- 3,833,197 9/1974 Dyke ..... 281/45 X
- D. 234,172 1/1975 Ranney ..... D19/91 X
- D. 237,237 10/1975 Nelson ..... D6/184
- D. 239,531 4/1976 Clowe ..... D19/91

Primary Examiner—Bruce W. Dunkins  
Attorney, Agent, or Firm—Marck C. Jacobs

[57] CLAIM

The ornamental design for a reading stand or the like or similar article, substantially as shown and described.

DESCRIPTION

FIG. 1 is a front elevational view of the reading stand or the like of my novel design.

FIG. 2 is a right side elevational view of the reading stand of my design.

FIG. 3 is an enlarged detail view in perspective of the reading material support portion of the instant design;

FIG. 4 is a rear elevational view of the stand as shown in FIG. 1; and,

FIG. 5 is a top plan view thereof.

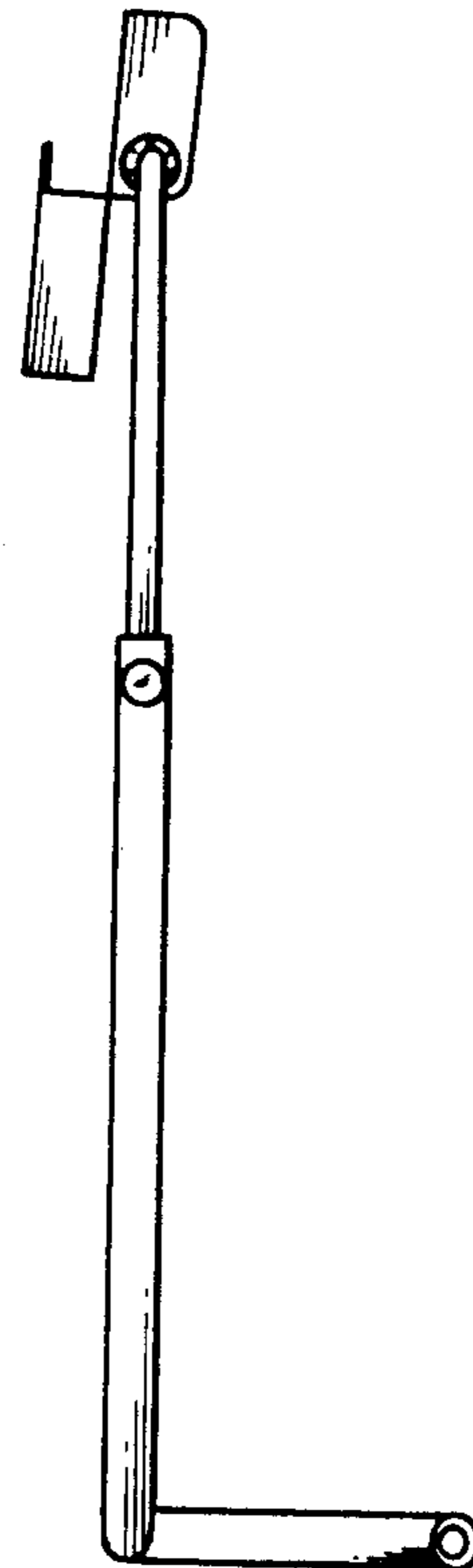
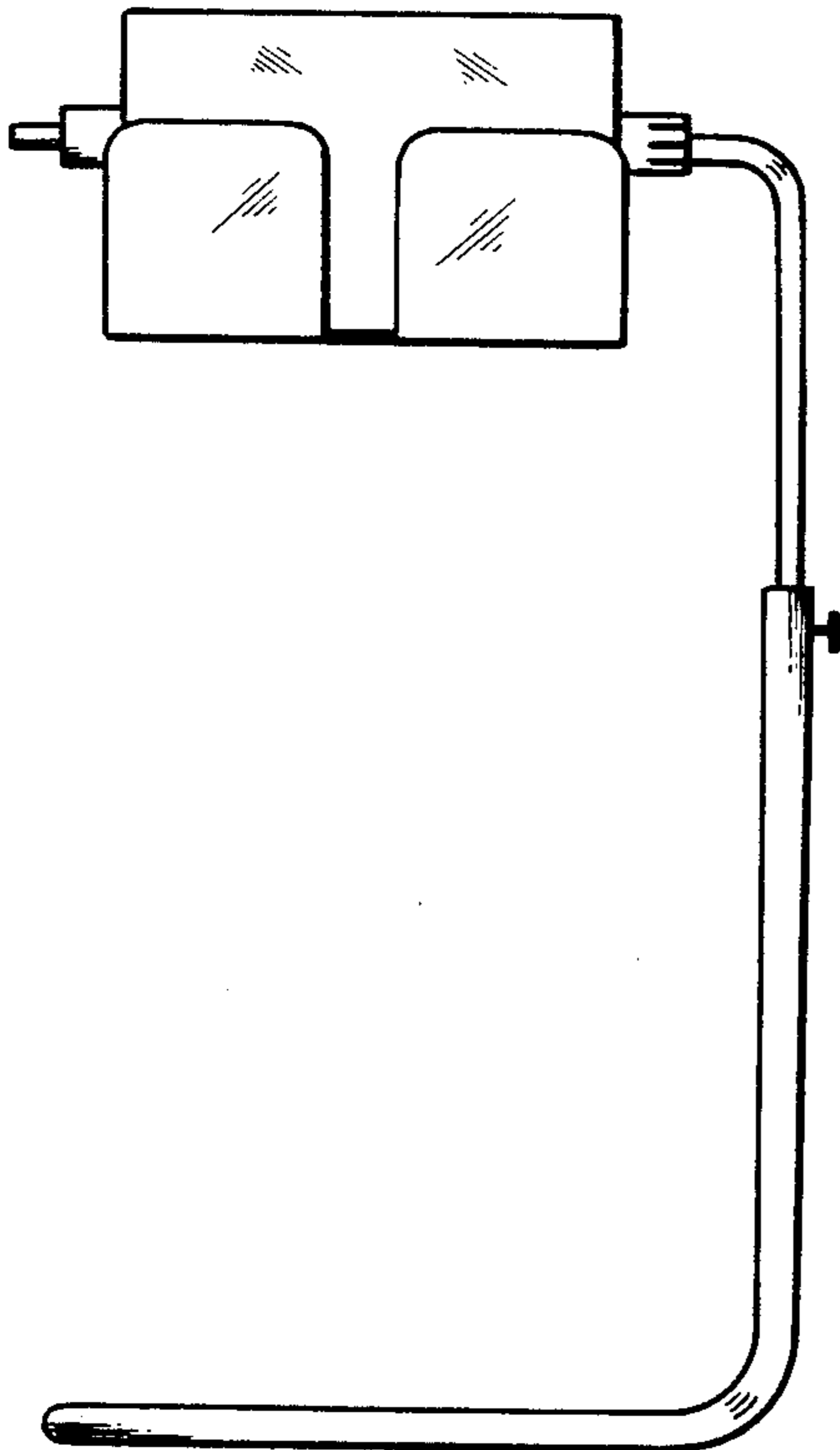

FIG - 1

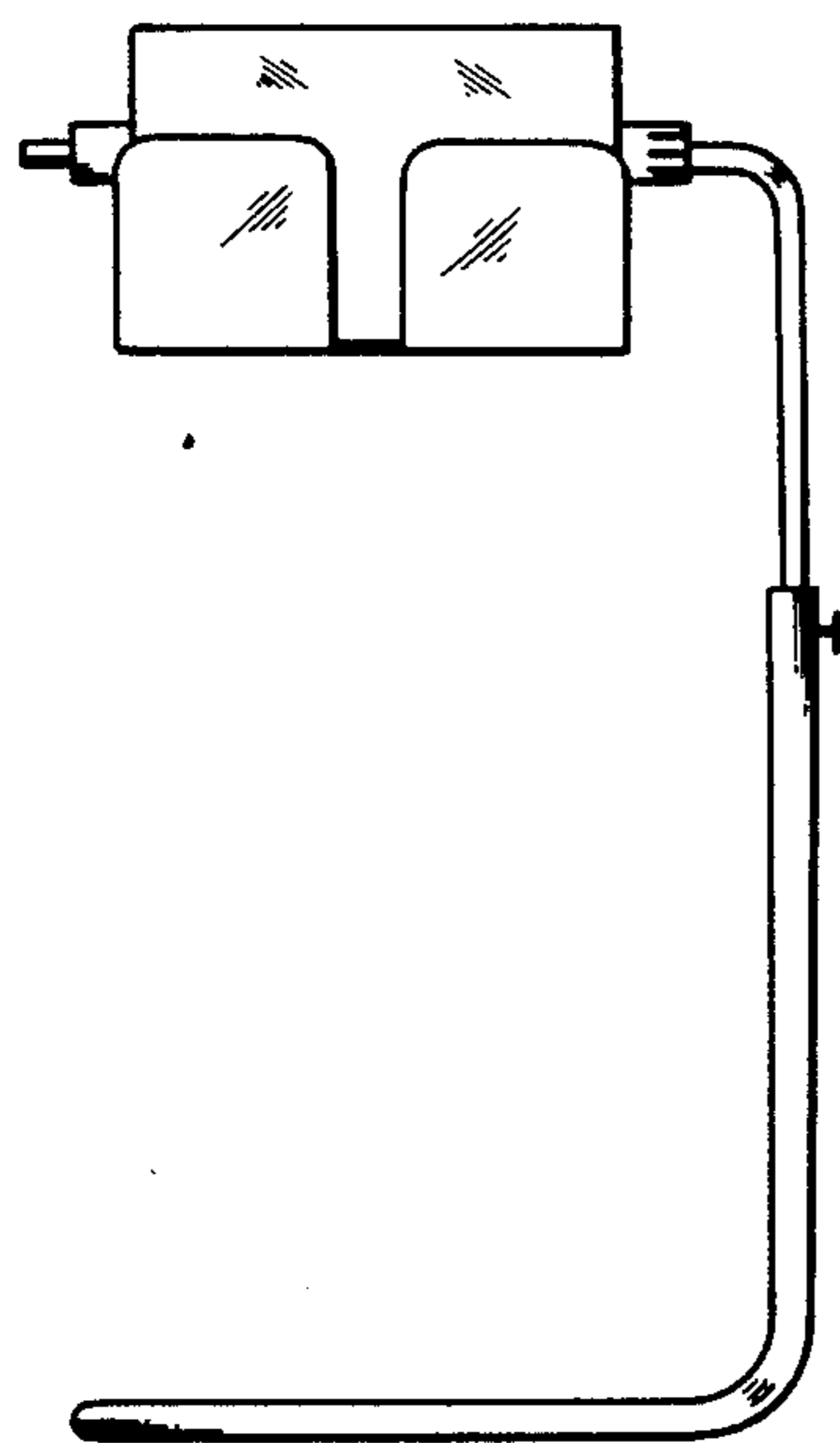

FIG - 2

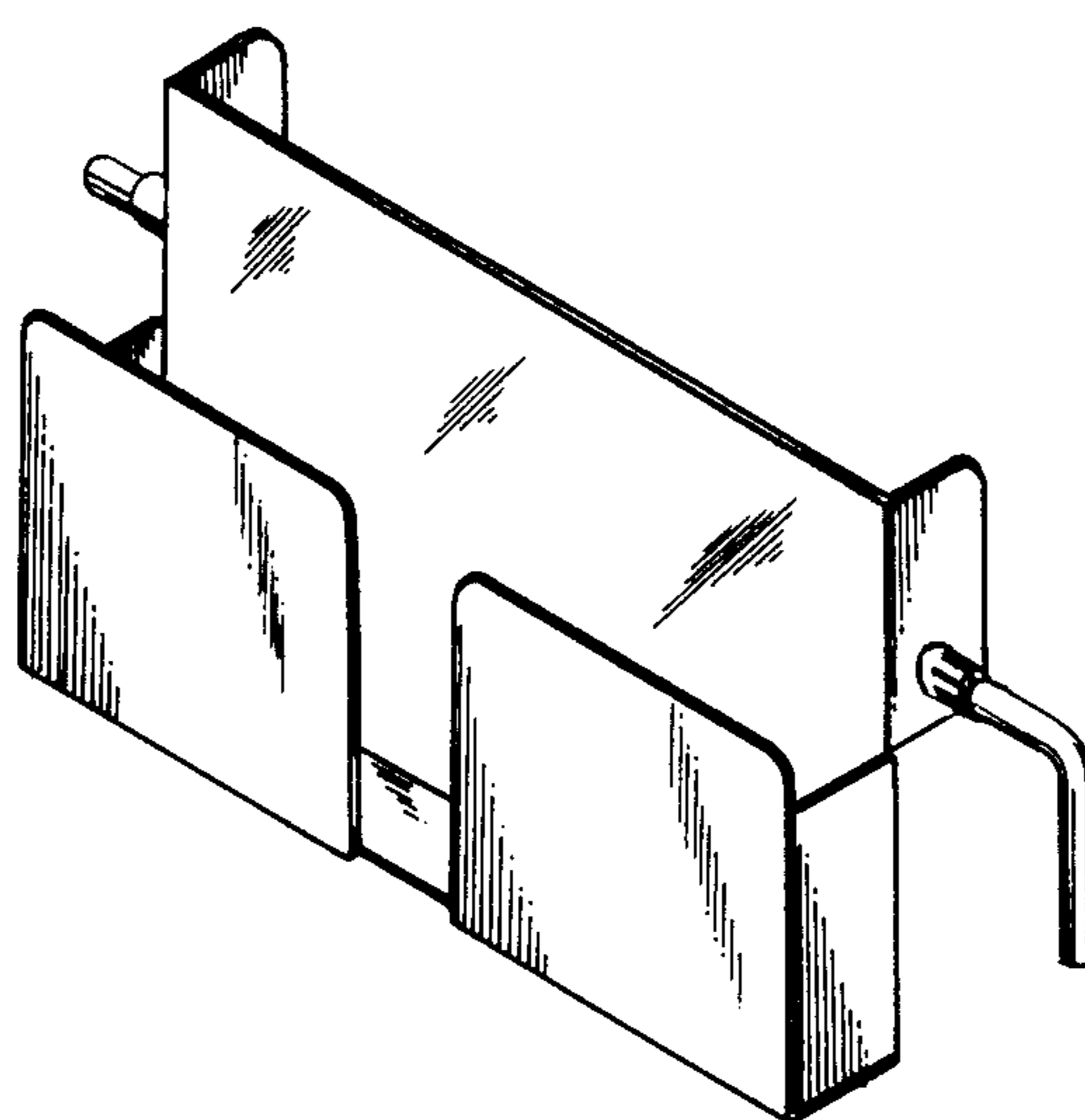
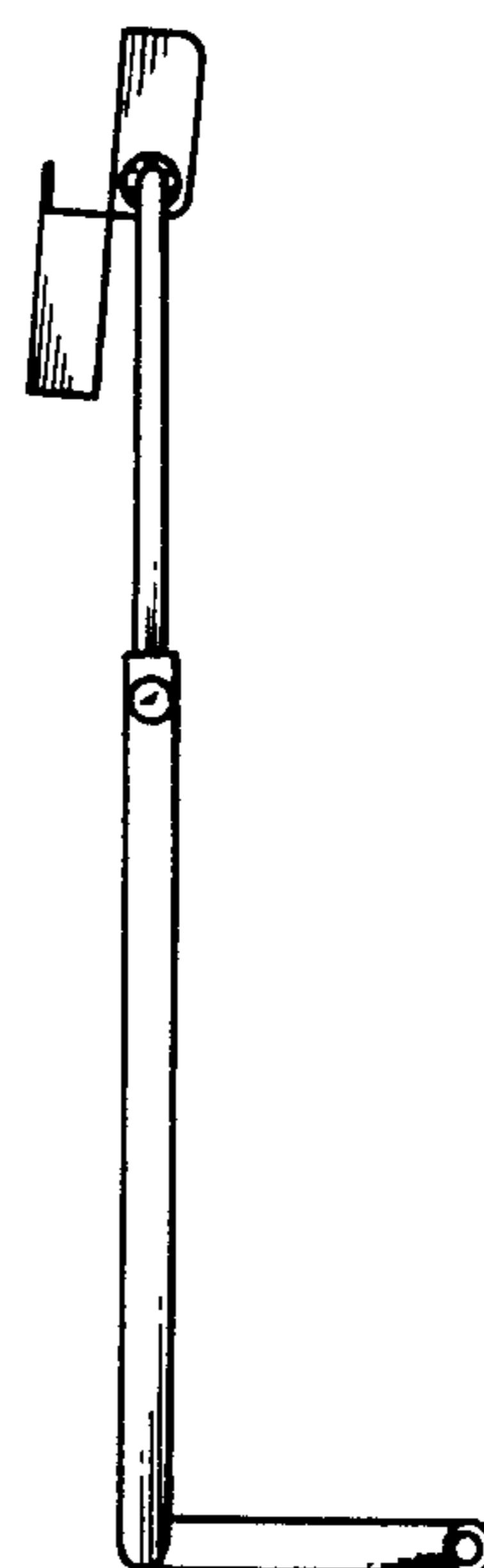

FIG - 3

FIG - 4

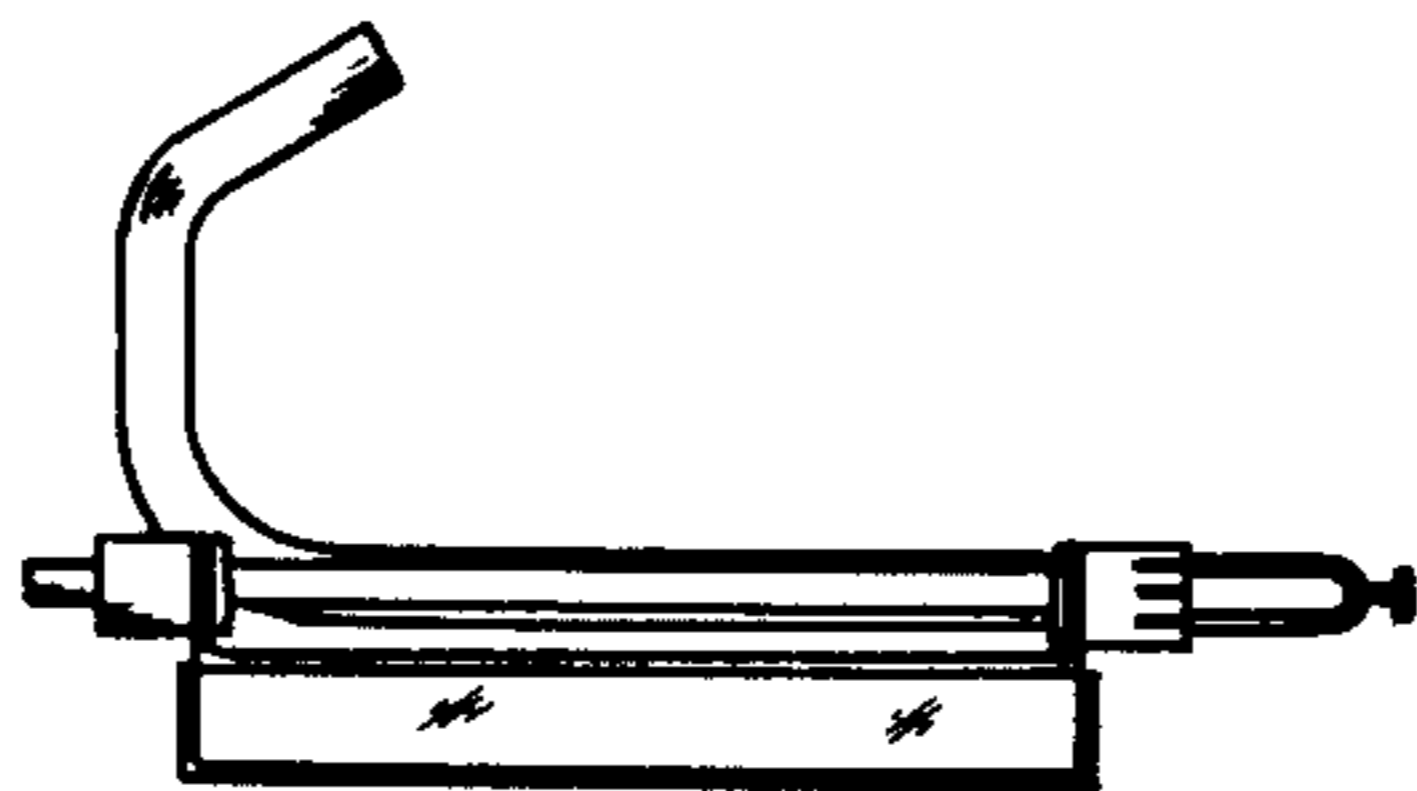
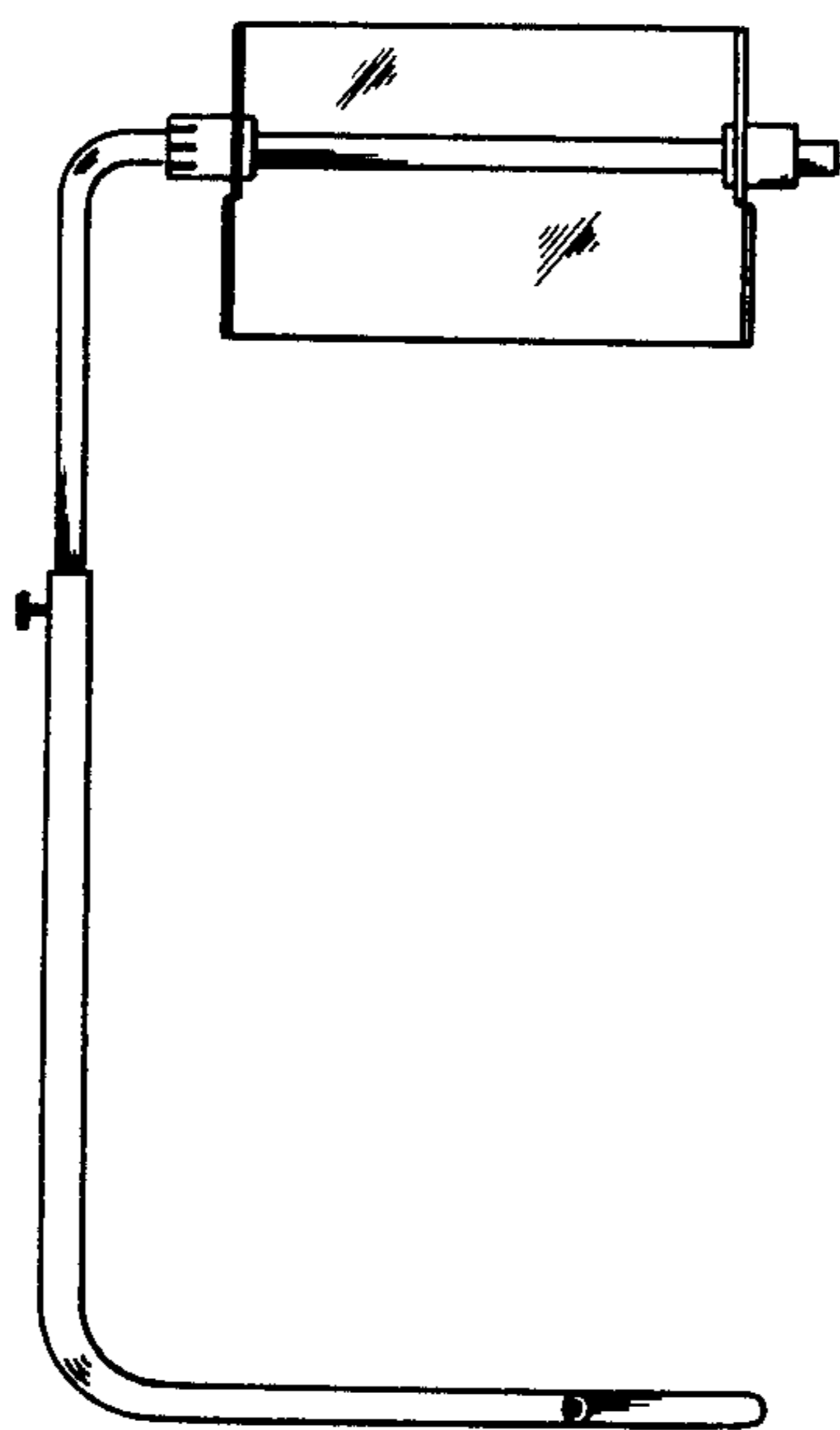

FIG - 5