

[54] **COLLAPSIBLE CART**

[76] **Inventor:** Melvin R. Martens, 406 N. Weaver,
Hesston, Kans. 67062

[**] **Term:** 14 Years

[21] **Appl. No.:** 714,082

[22] **Filed:** Aug. 13, 1976

[51] **Int. Cl.** D12-02

[52] **U.S. Cl.** D12/24

[58] **Field of Search** D12/24, 32; 280/639,
280/645, 646, 47.13 R, 47.17, 47.19, 47.24,
47.26, 47.27, 47.28, 47.3, 47.31, 47.32, 79.1,
79.2, 79.3

[56] **References Cited**

U.S. PATENT DOCUMENTS

2,800,335 7/1957 Clapp D12/24

3,024,547 3/1962 Harrison D12/24

3,166,339 1/1965 Earley 280/47.26

3,552,760 1/1971 Sine 280/47.31

3,722,904 3/1973 Puckett 280/47.31

Primary Examiner—Wallace R. Burke
Assistant Examiner—James M. Gandy
Attorney, Agent, or Firm—Gordon D. Schmidt

[57] **CLAIM**

The ornamental design for a collapsible cart, as shown.

DESCRIPTION

FIG. 1 is a top plan view of a collapsible cart showing my new design in its fully unfolded position;
FIG. 2 is a side elevational view thereof;
FIG. 3 is a front elevational view thereof;
FIG. 4 is a rear elevational view thereof;
FIG. 5 is a top plan view thereof in its collapsed position; and
FIG. 6 is a side elevational view of FIG. 5.

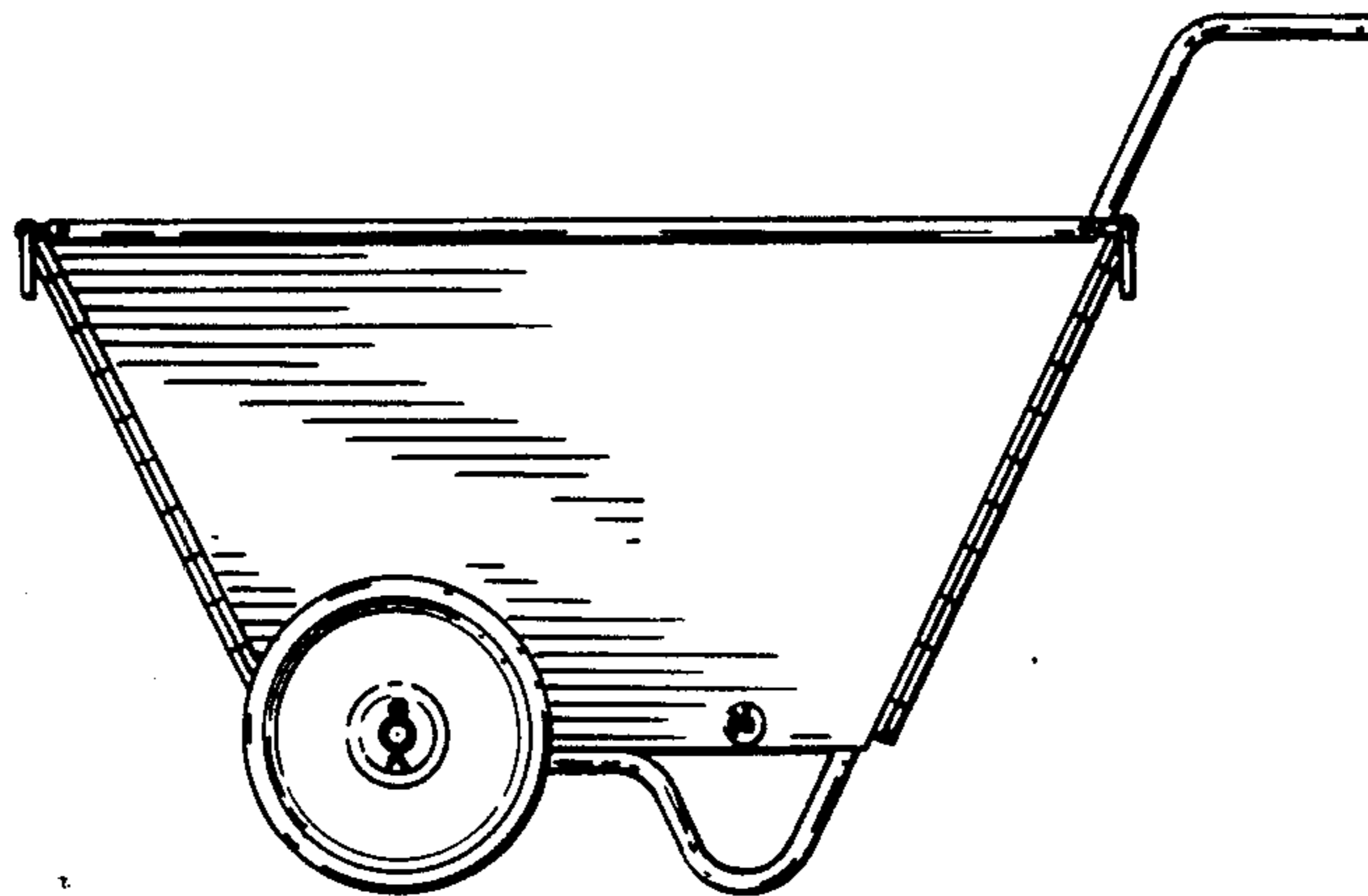
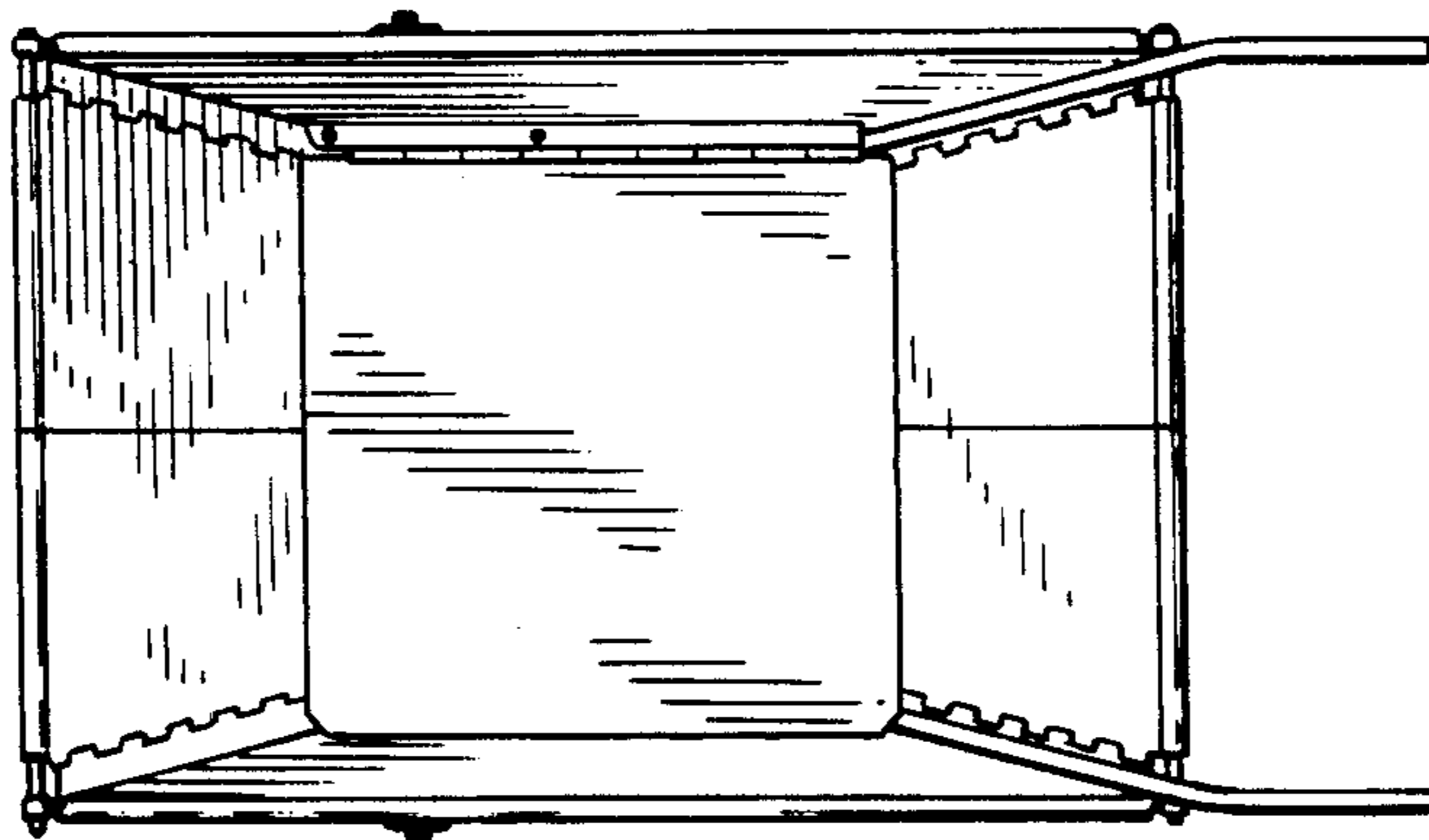

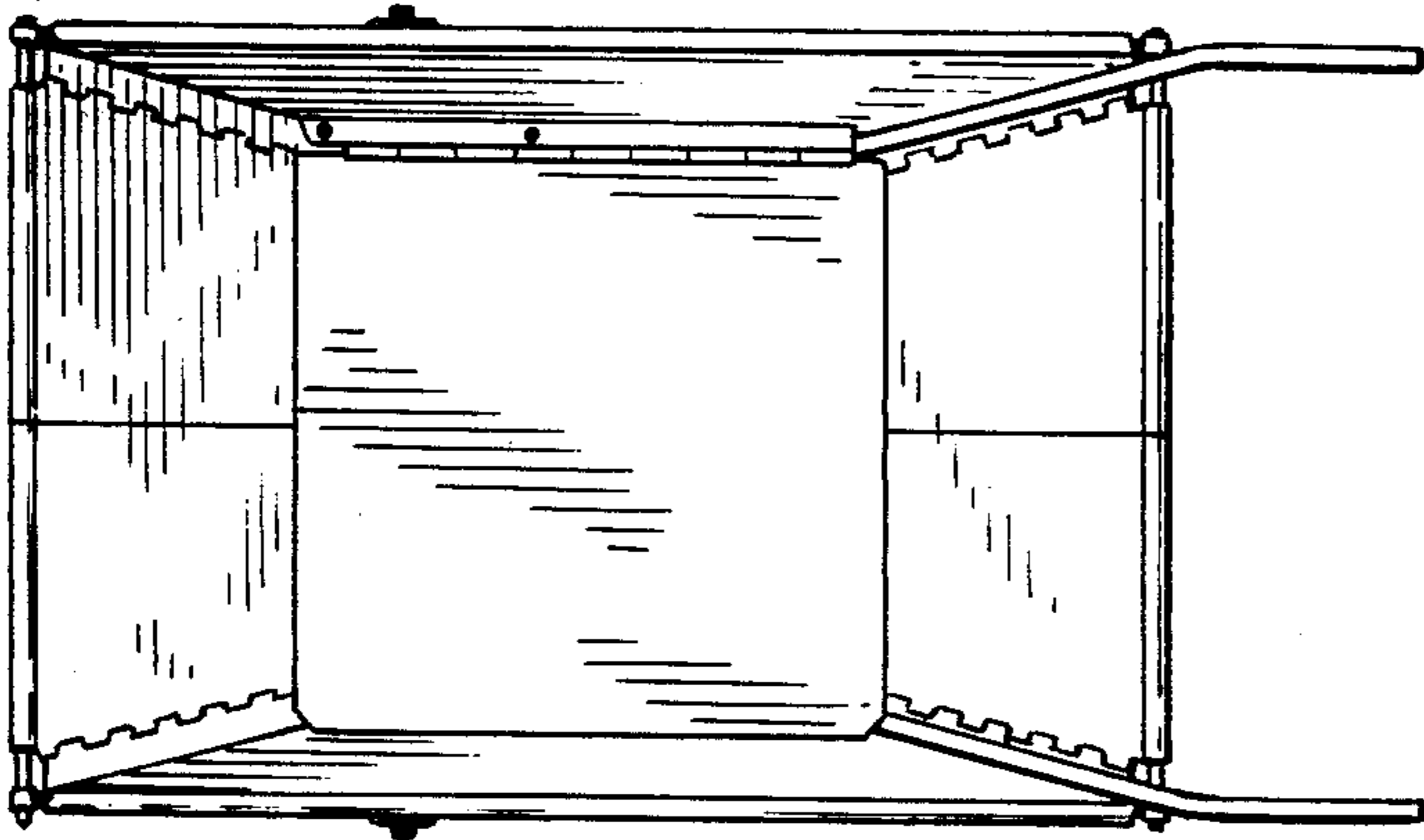

Fig. 1.

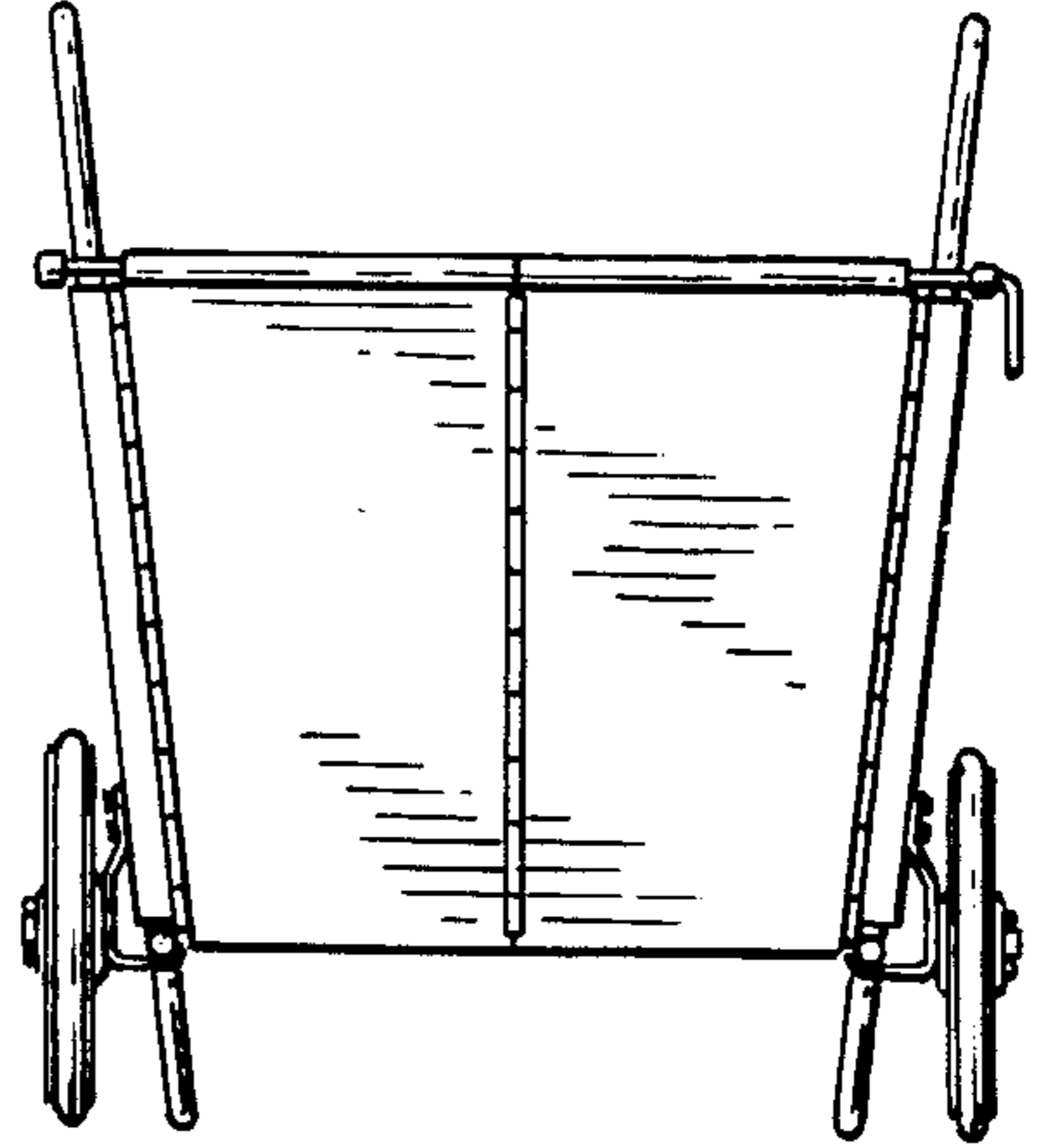

Fig. 3.

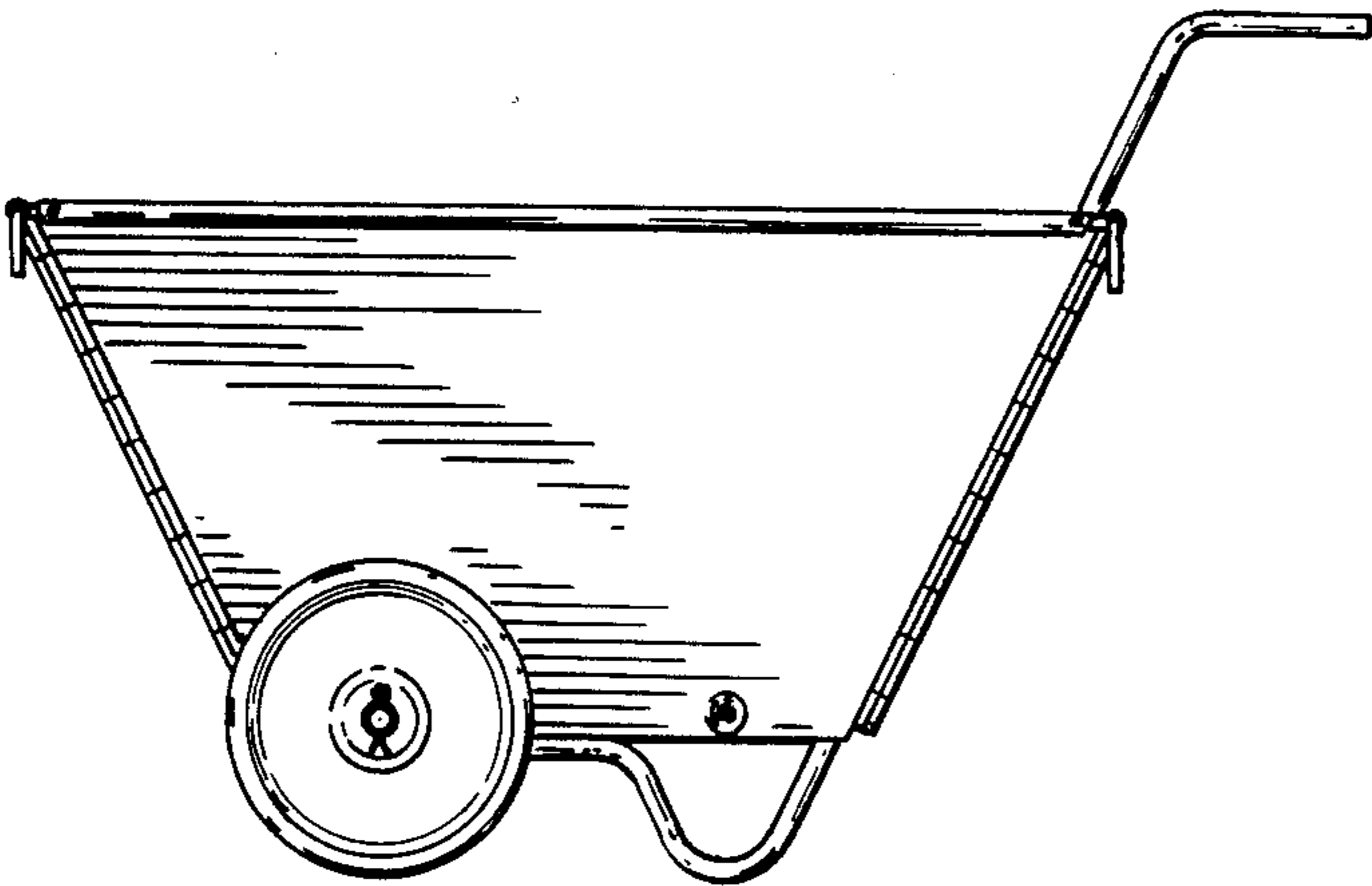

Fig. 2.

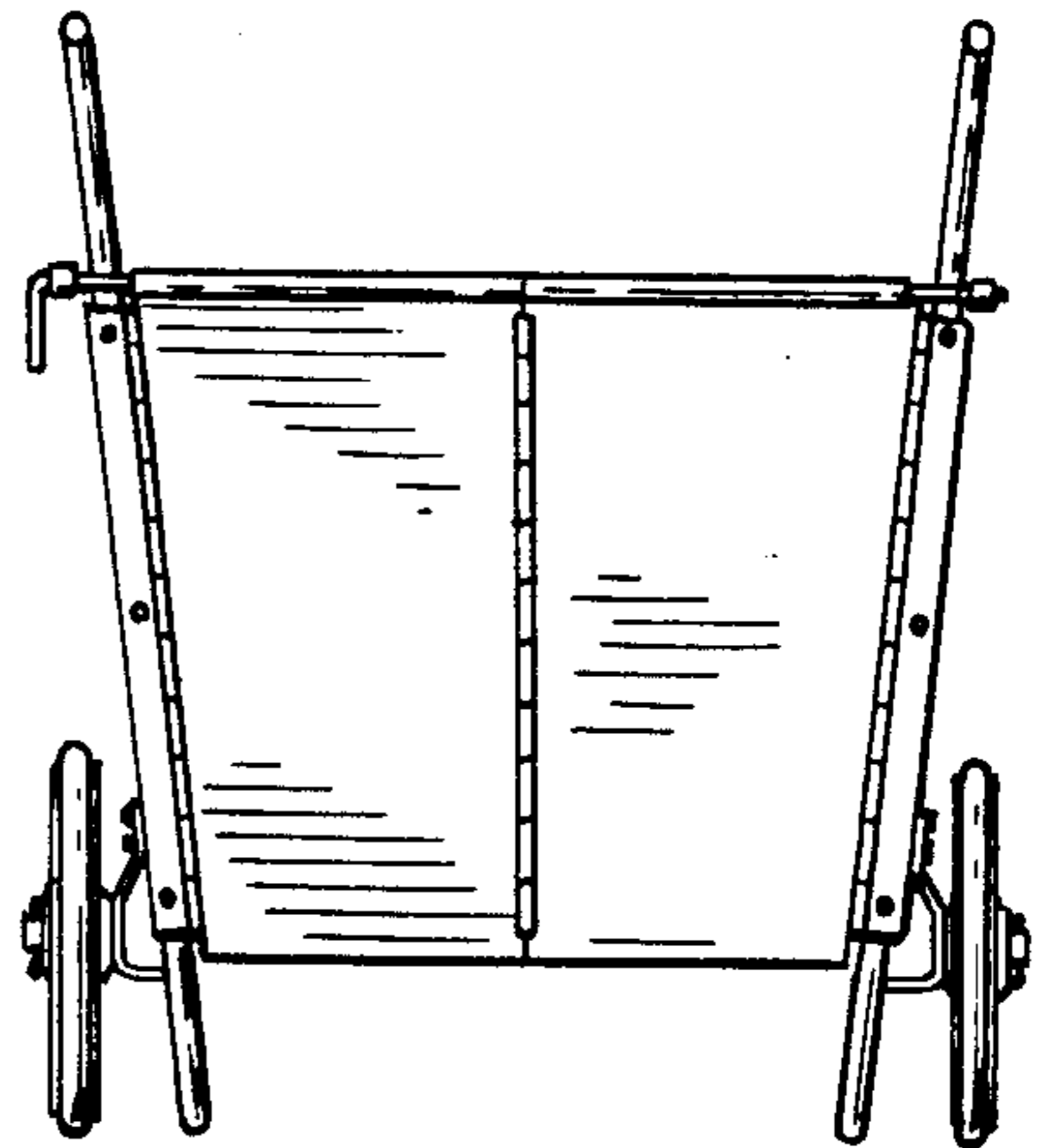

Fig. 4.

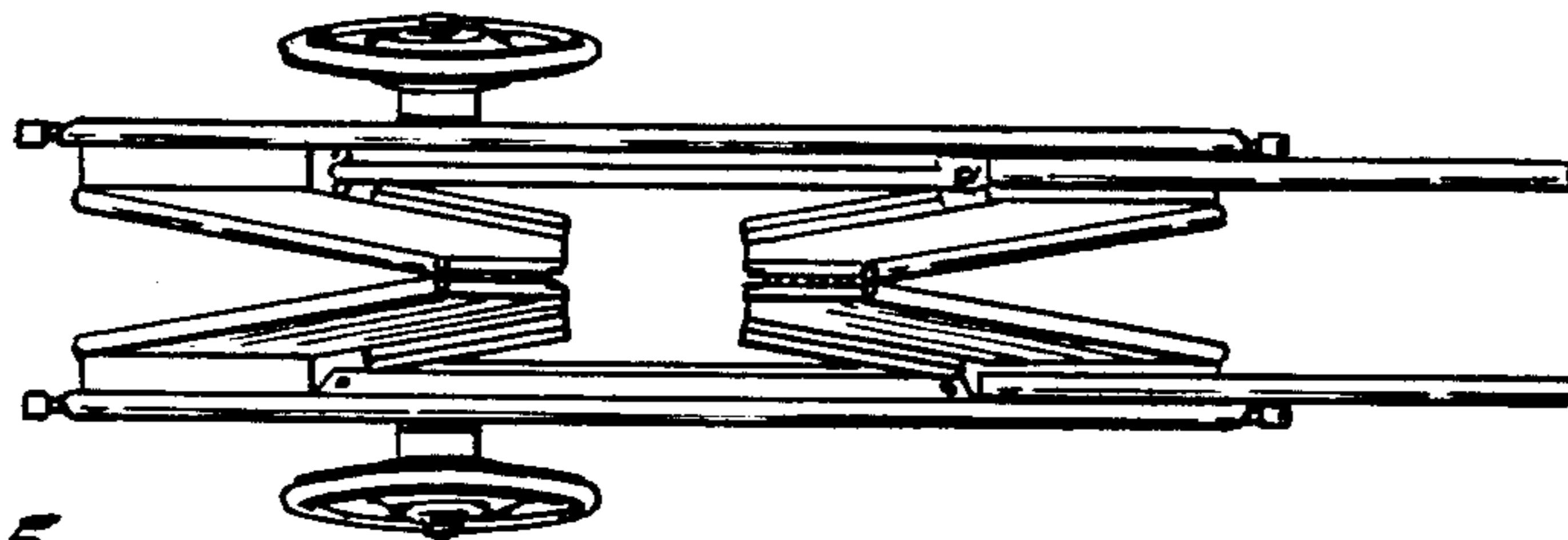

Fig. 5.

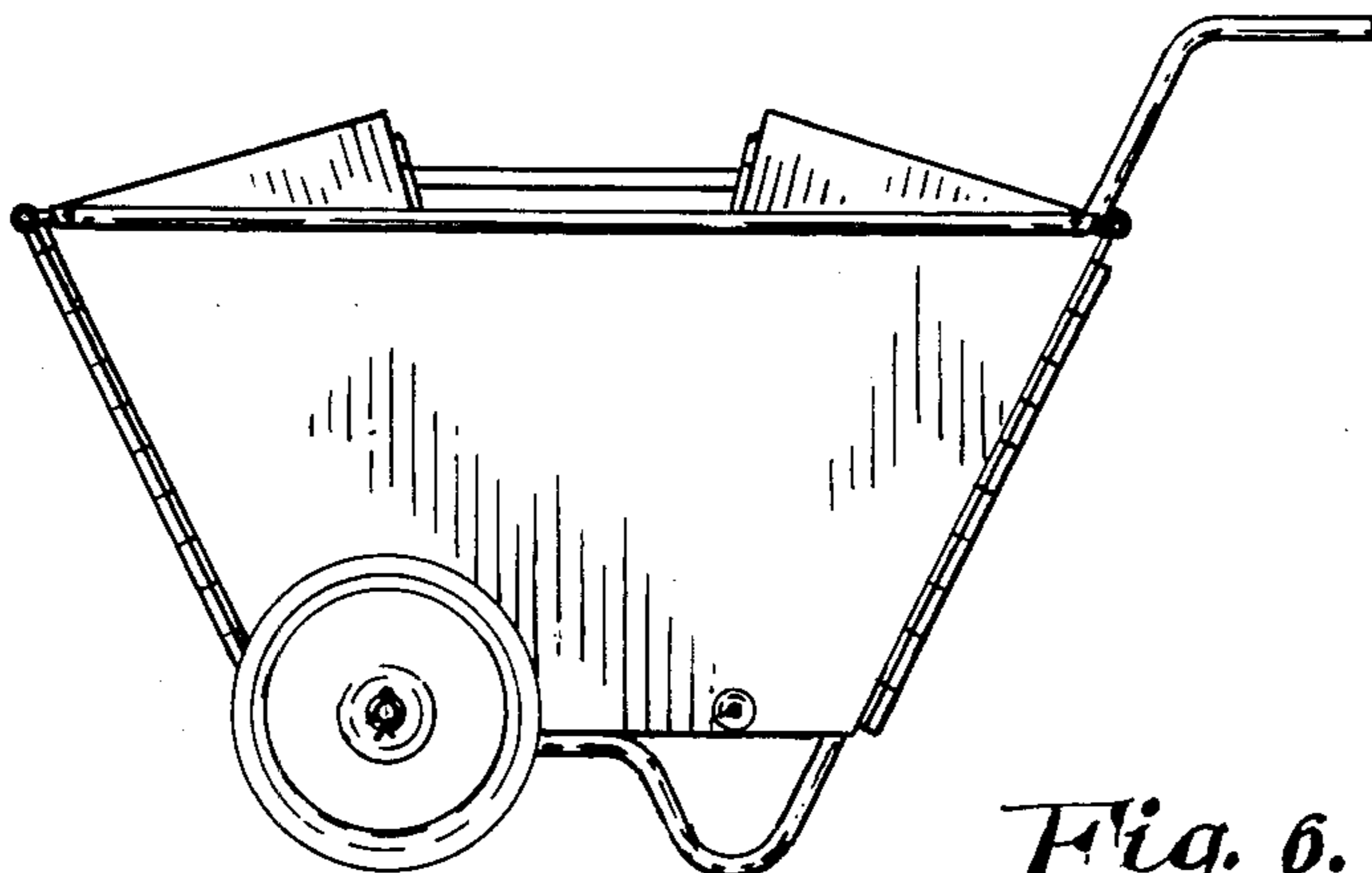

Fig. 6.