

[54] LAMP

[76] Inventor: Chester Urban, 2832 Wilmot St., Philadelphia, Pa. 19137

[\*\*] Term: 14 Years

[21] Appl. No.: 690,451

[22] Filed: May 27, 1976

[51] Int. Cl. .... D26-05

[52] U.S. Cl. .... D48/20 C

[58] Field of Search ..... D48/20 R, 20 A, 20 C, D48/16 R, 20 B; 240/2 SL, 10 R, 81 R, 81 BS, 108 R; D11/131, 157, 158, 160; D34/5 DD, 5 MM

[56] References Cited

U.S. PATENT DOCUMENTS

3,525,171	8/1970	Gilman .....	D34/5 DD X
D. 51,269	9/1917	Robb et al. ....	D48/20 R
D. 130,928	12/1941	Spotts .....	D48/20 C
D. 132,011	4/1942	Hansen .....	D48/20 C
D. 161,375	12/1950	Reinhardt .....	D11/160 X

Primary Examiner—Susan J. Lucas

Attorney, Agent, or Firm—Arthur H. Seidel

[57] CLAIM

The ornamental design for a lamp, substantially as shown and described.

DESCRIPTION

FIG. 1 is a front elevation view of a lamp showing my new design:

FIG. 2 is a right side elevation view thereof;

FIG. 3 is a left side elevation view thereof;

FIG. 4 is a rear elevation view thereof;

FIG. 5 is a top plan view thereof;

FIG. 6 is a bottom plan view thereof;

FIG. 7 is a plan developed view of the lamp shade of the lamp illustrated in FIGS. 1-6 illustrating the detail of said lamp shade;

FIG. 8 is a front elevation view of a lamp showing a modified form of my new design;

FIG. 9 is a right side elevation view thereof;

FIG. 10 is a left side elevation view thereof;

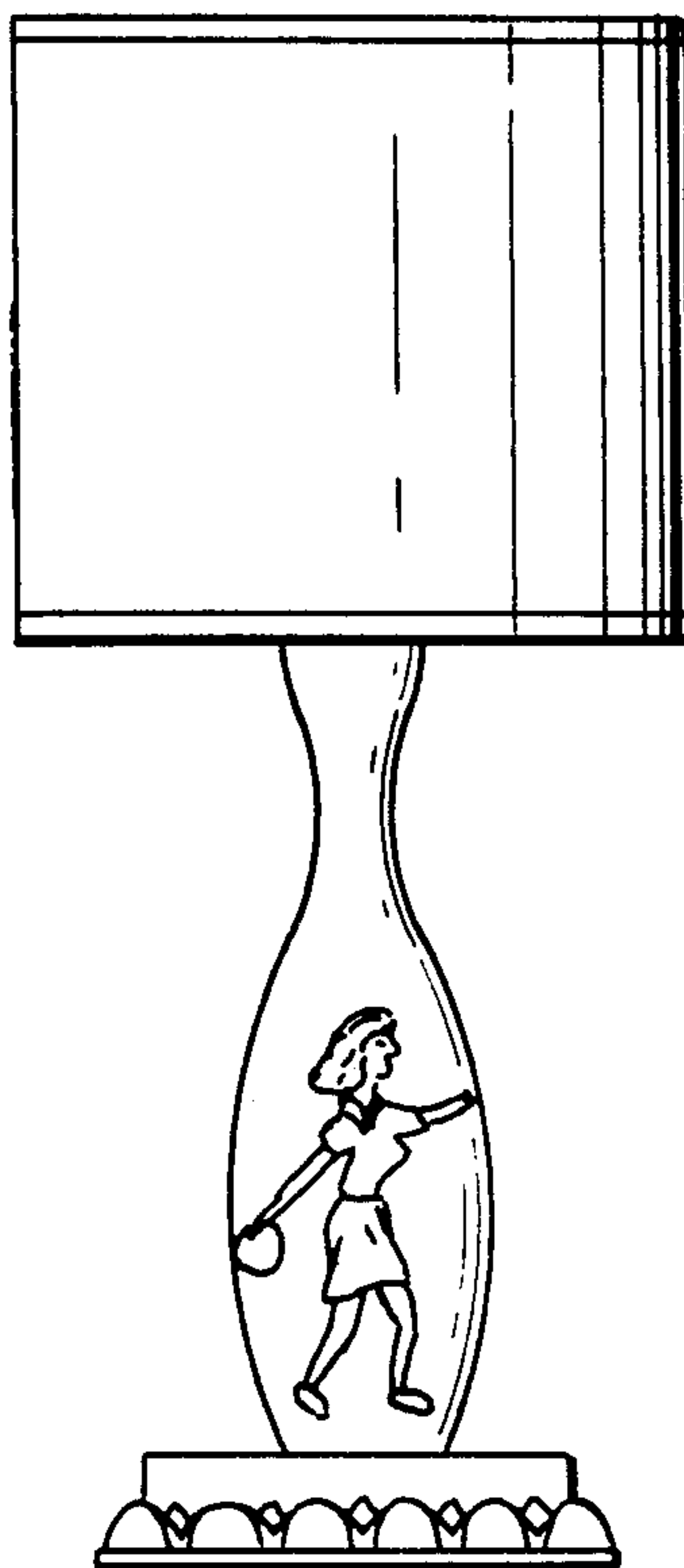
FIG. 11 is a rear elevation view thereof;

FIG. 12 is a top plan view thereof;

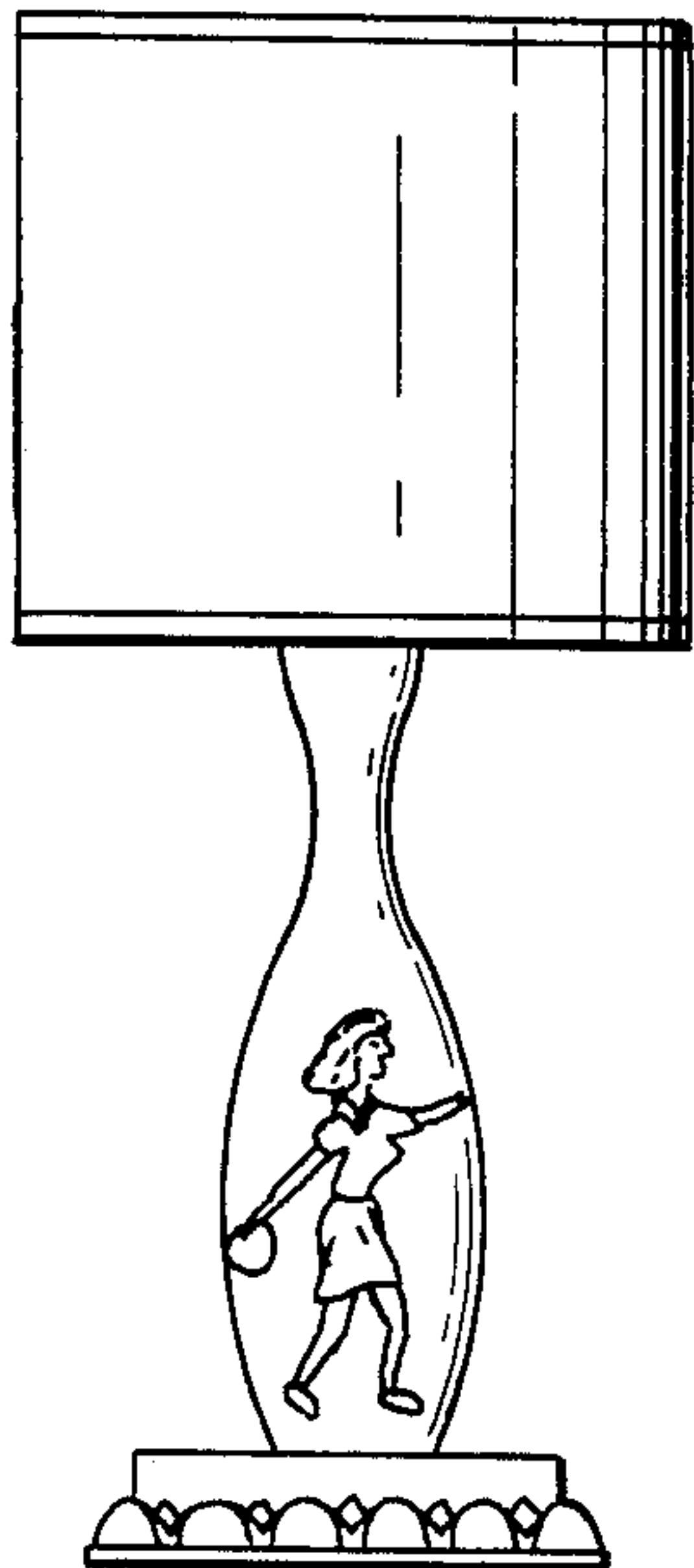
FIG. 13 is a bottom plan view thereof;

FIG. 14 is a plan developed view of the lamp shade of the lamp illustrated in FIGS. 8-13 illustrating the details of said lamp shade.

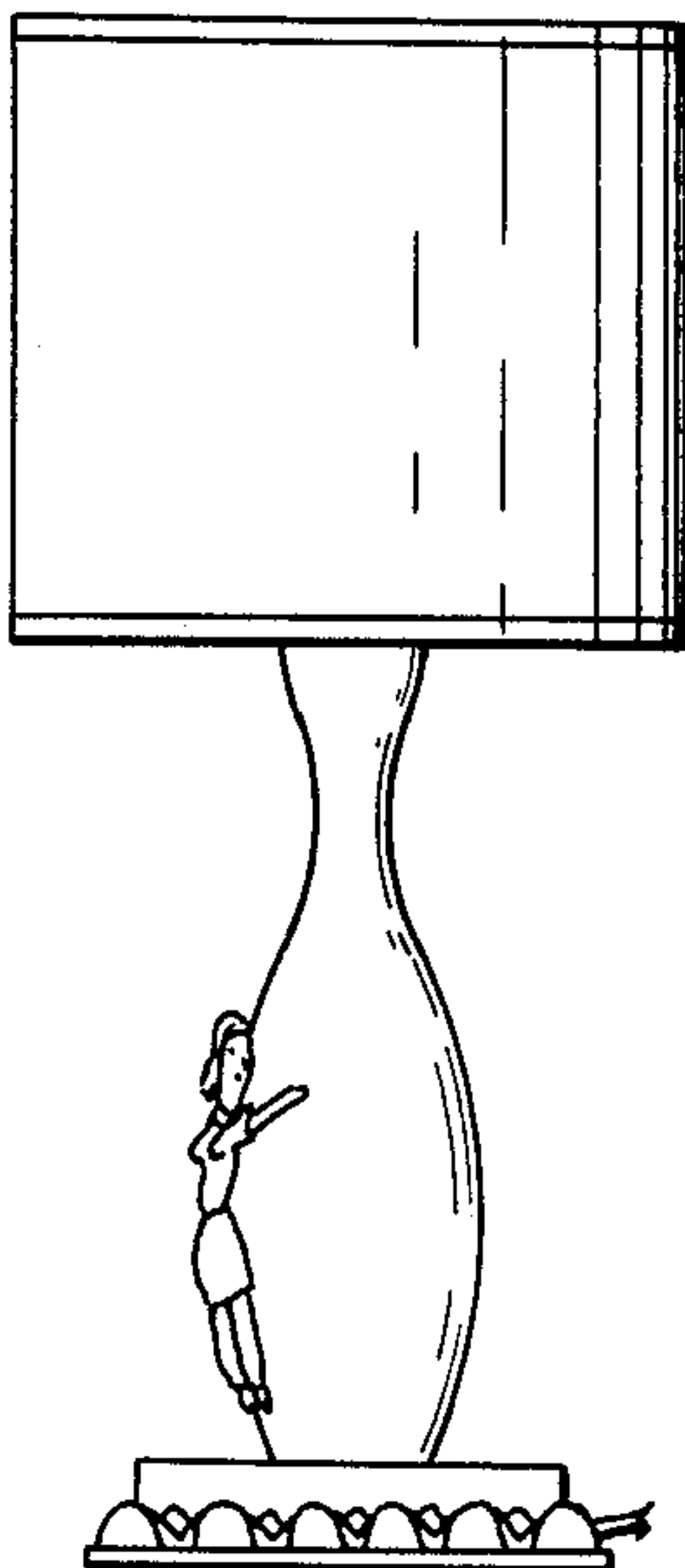
The detail of the lamp shade of the lamp illustrated in FIGS. 1-6 has been omitted from those Figures for ease of illustration and has been shown instead in FIG. 7. Similarly, the detail of the lamp shade of the lamp illustrated in FIGS. 8-13 has been omitted from those Figures for ease of illustration and has been shown instead in FIG. 14.



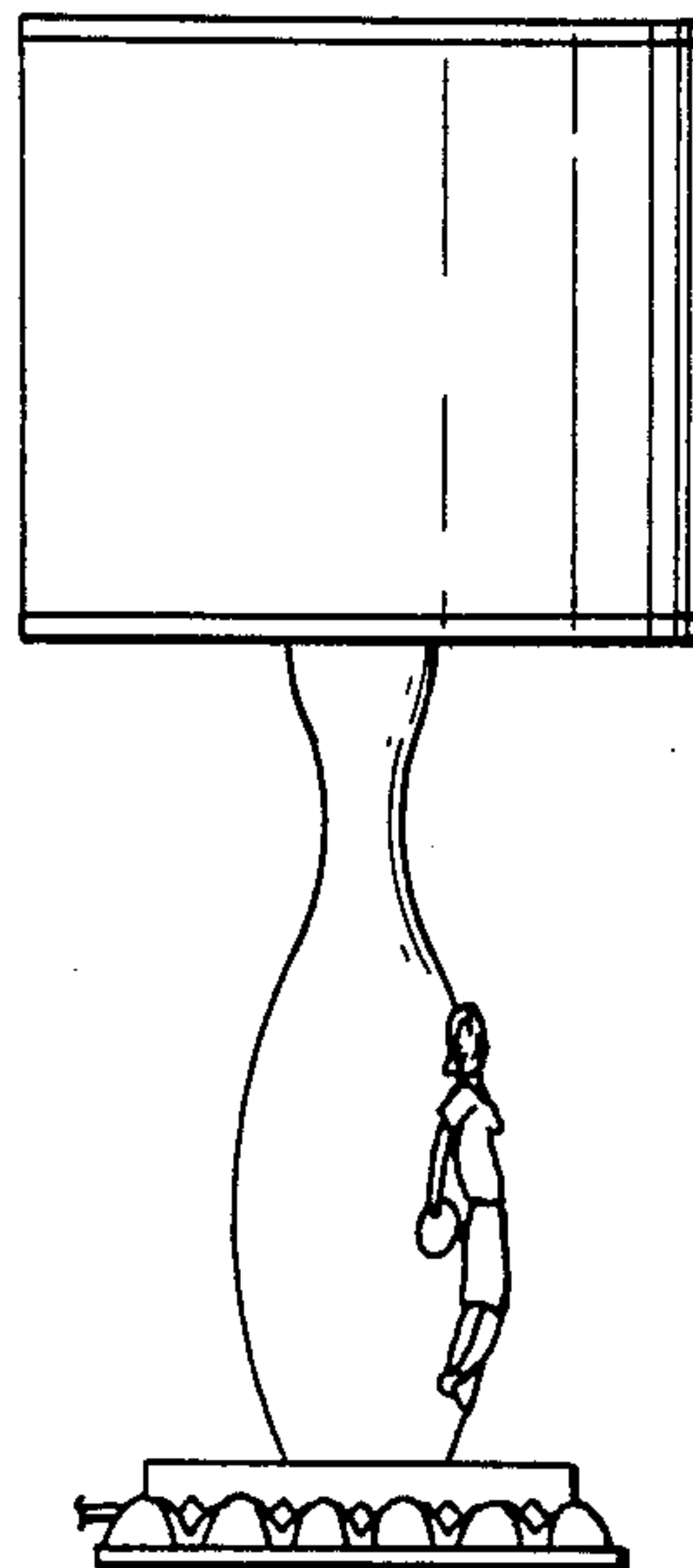
**FIG. 1**



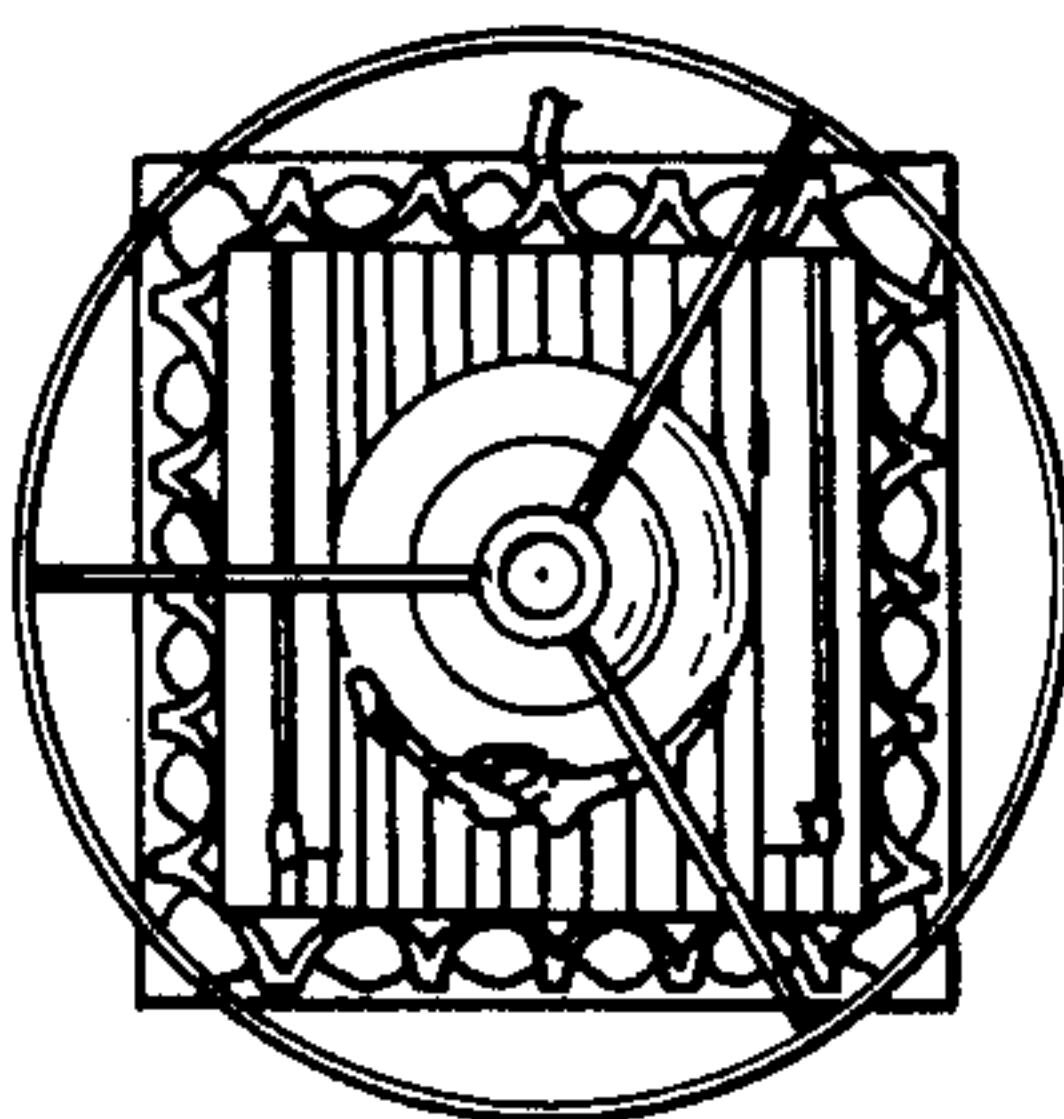
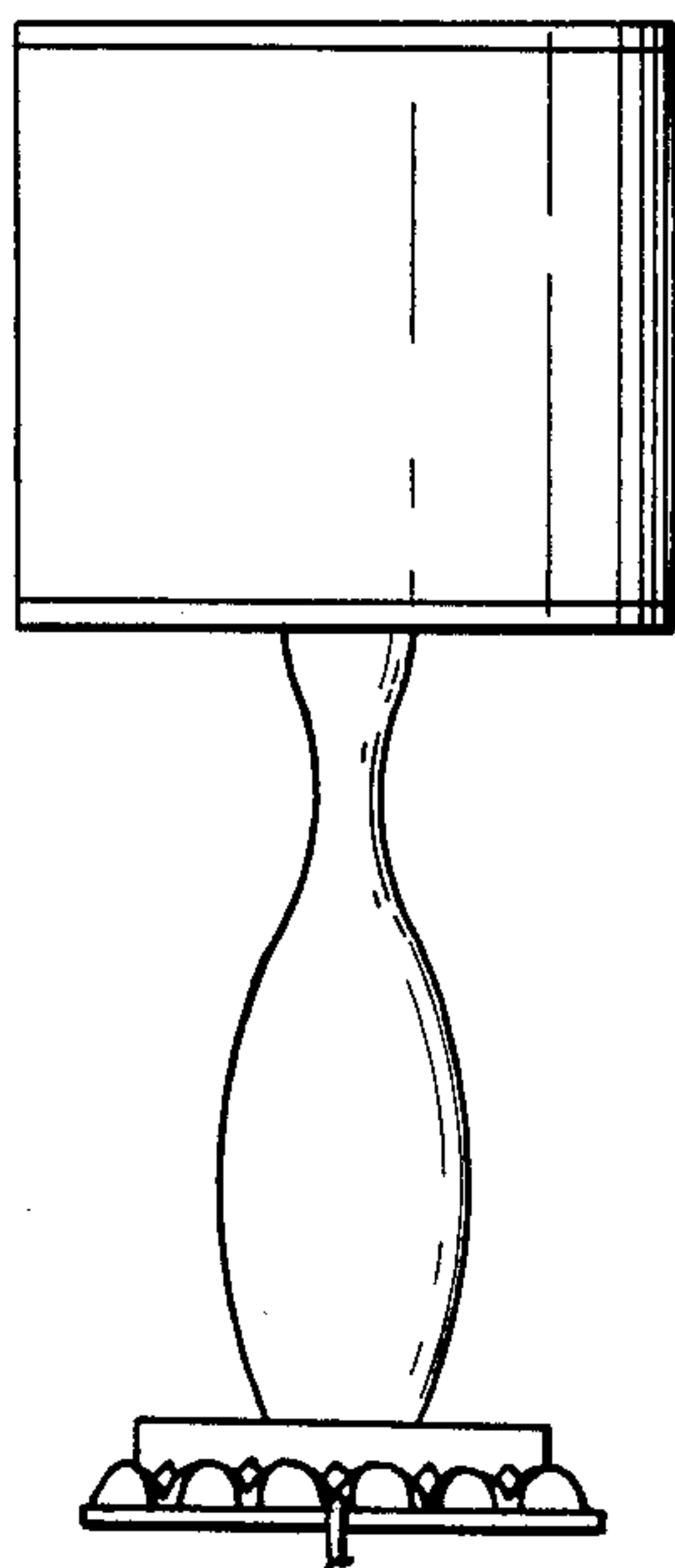
**FIG. 2**



**FIG. 3**

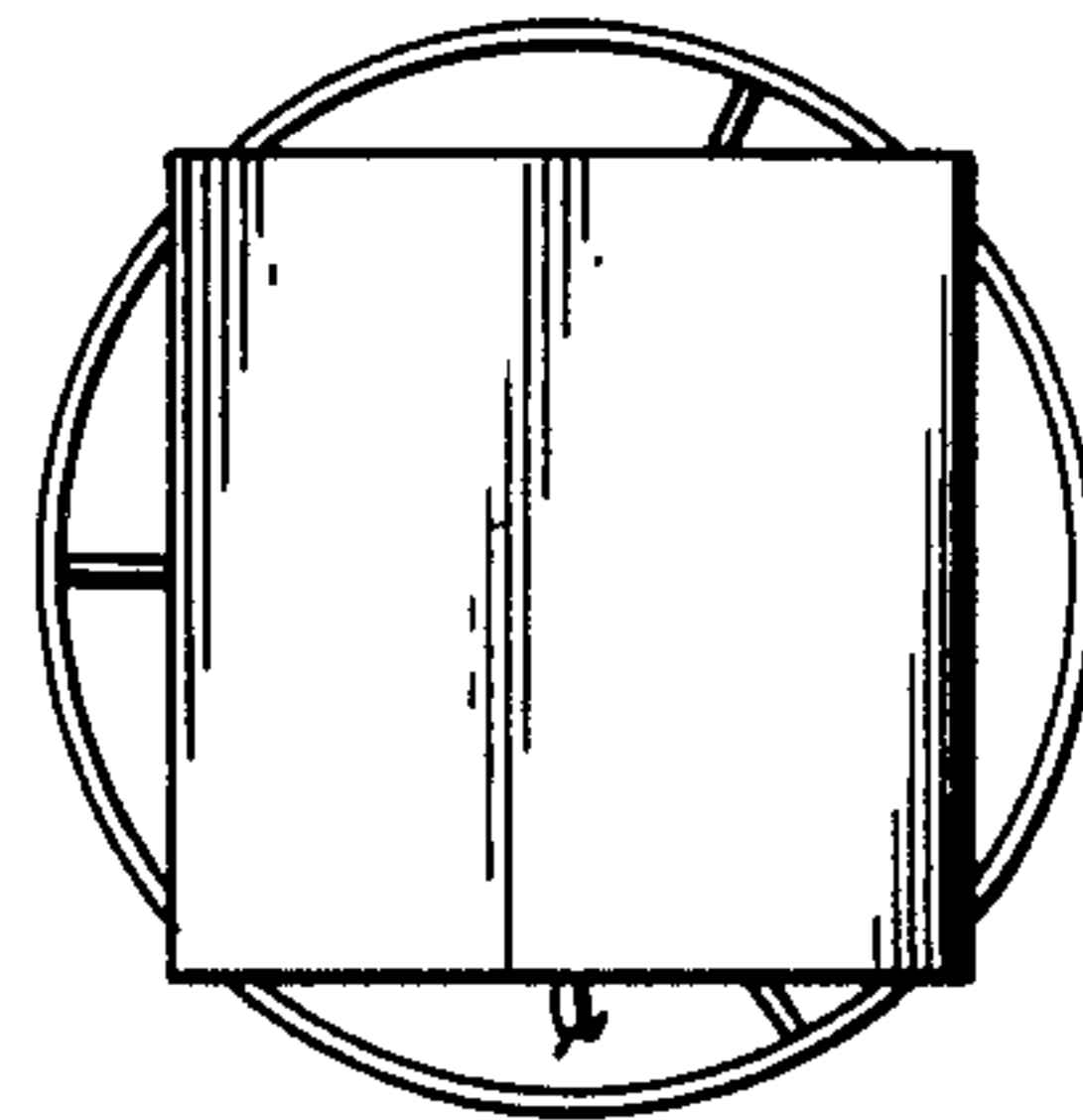


**FIG. 4**

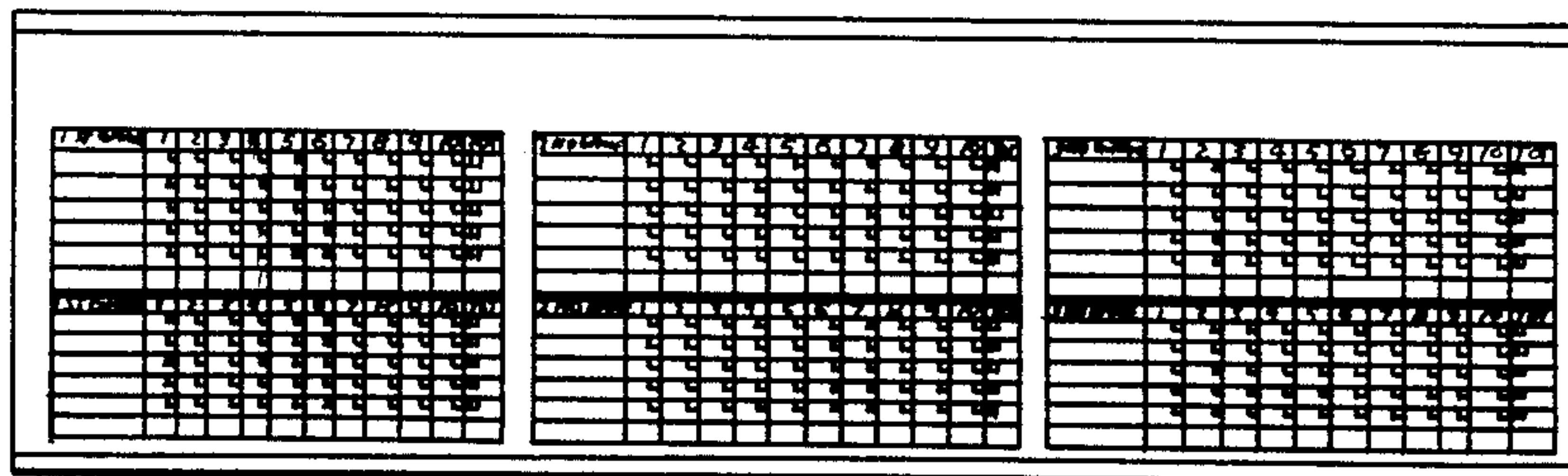


**FIG. 5**

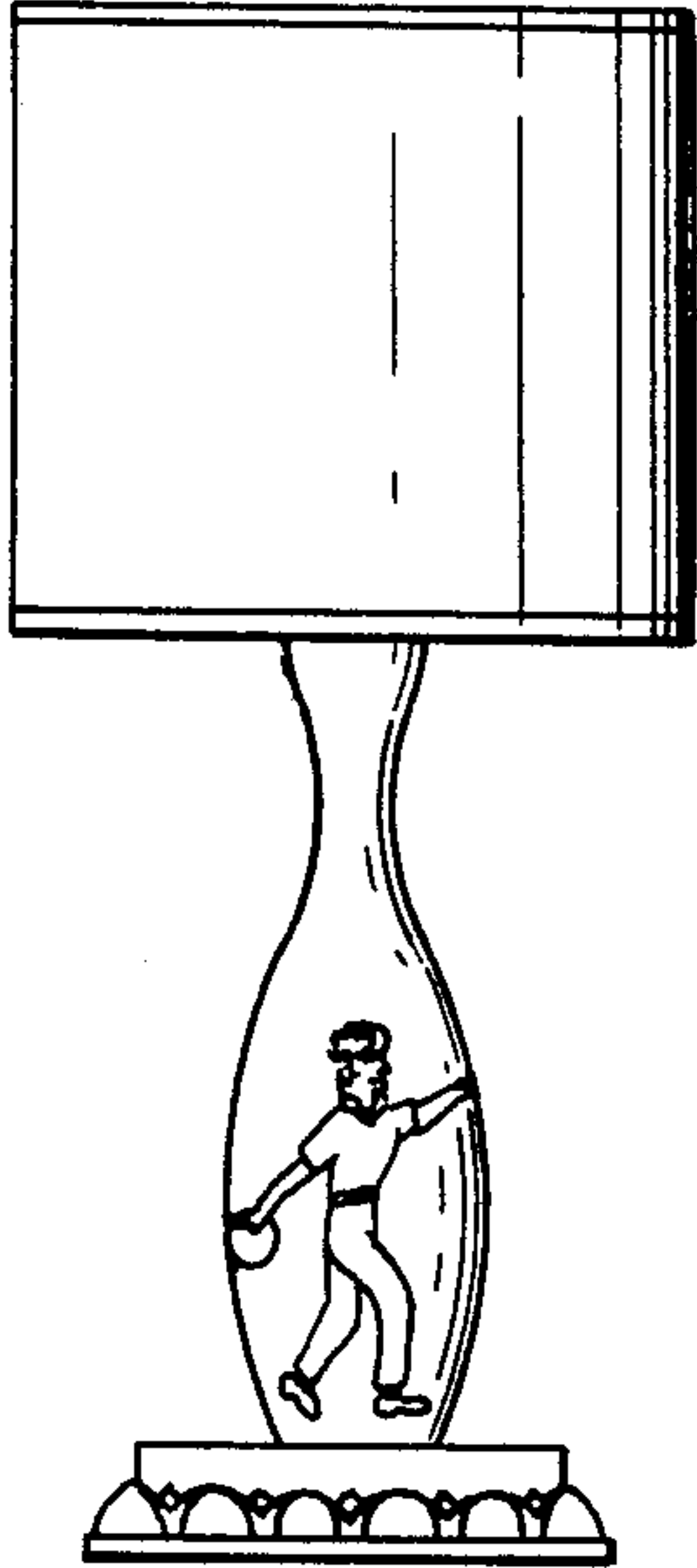
**FIG. 6**



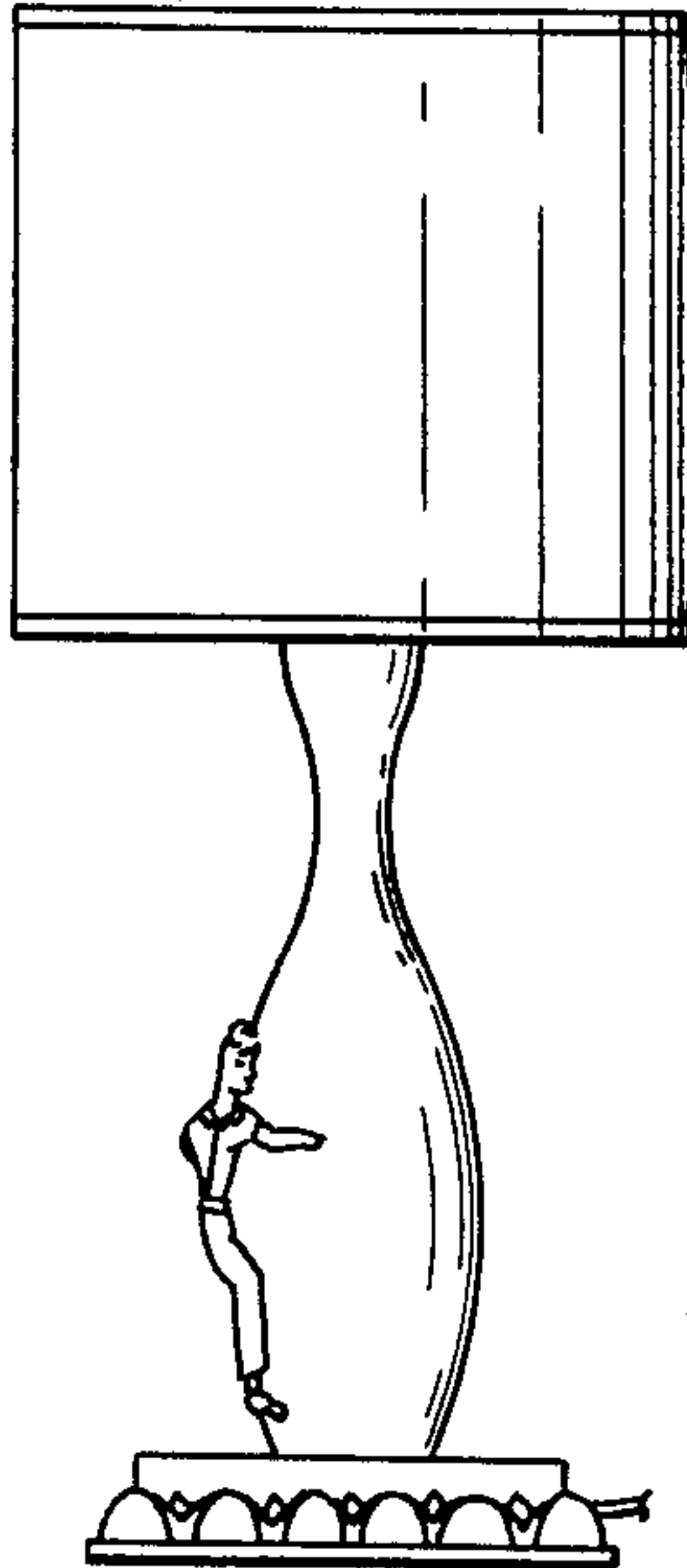
**FIG. 7**



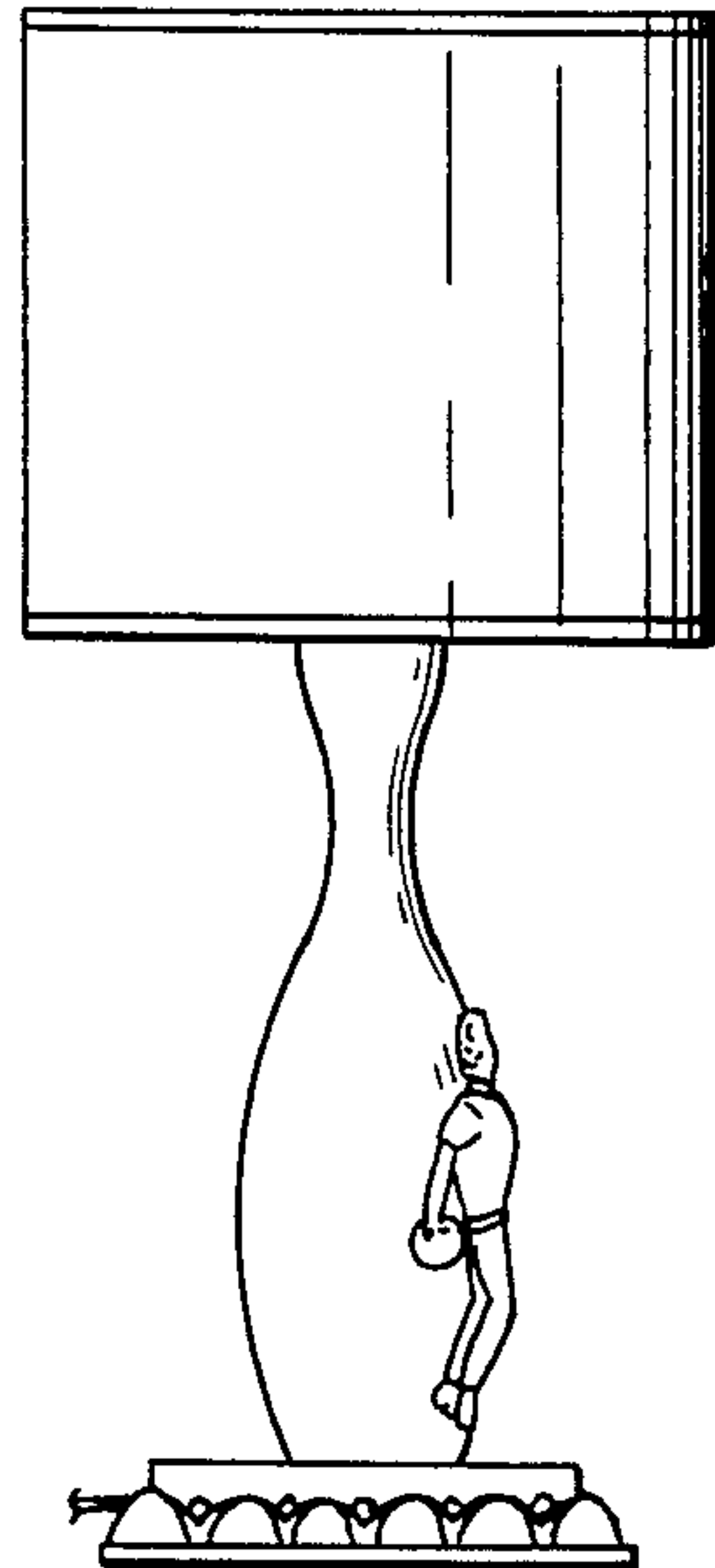
**FIG. 8**



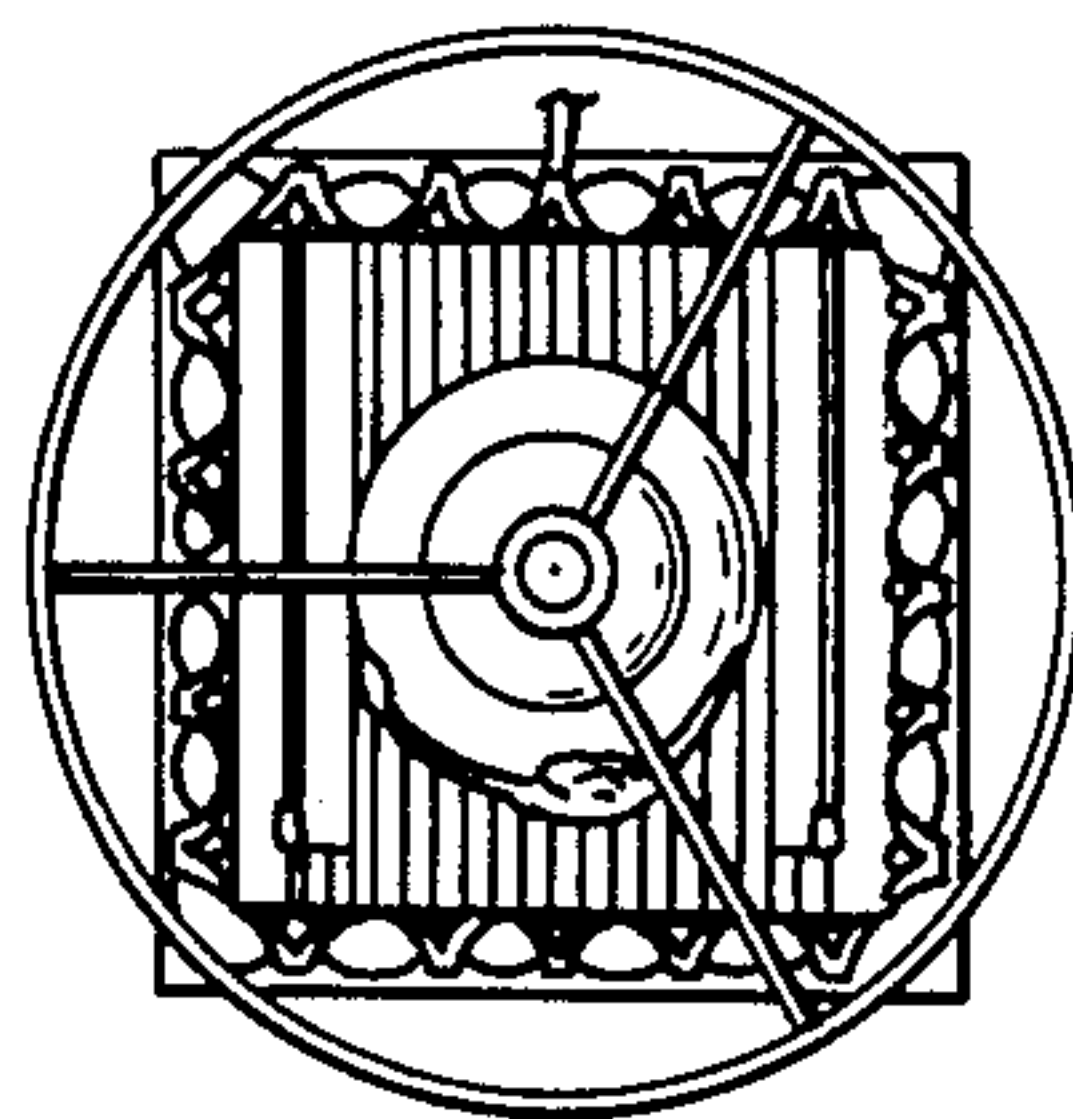
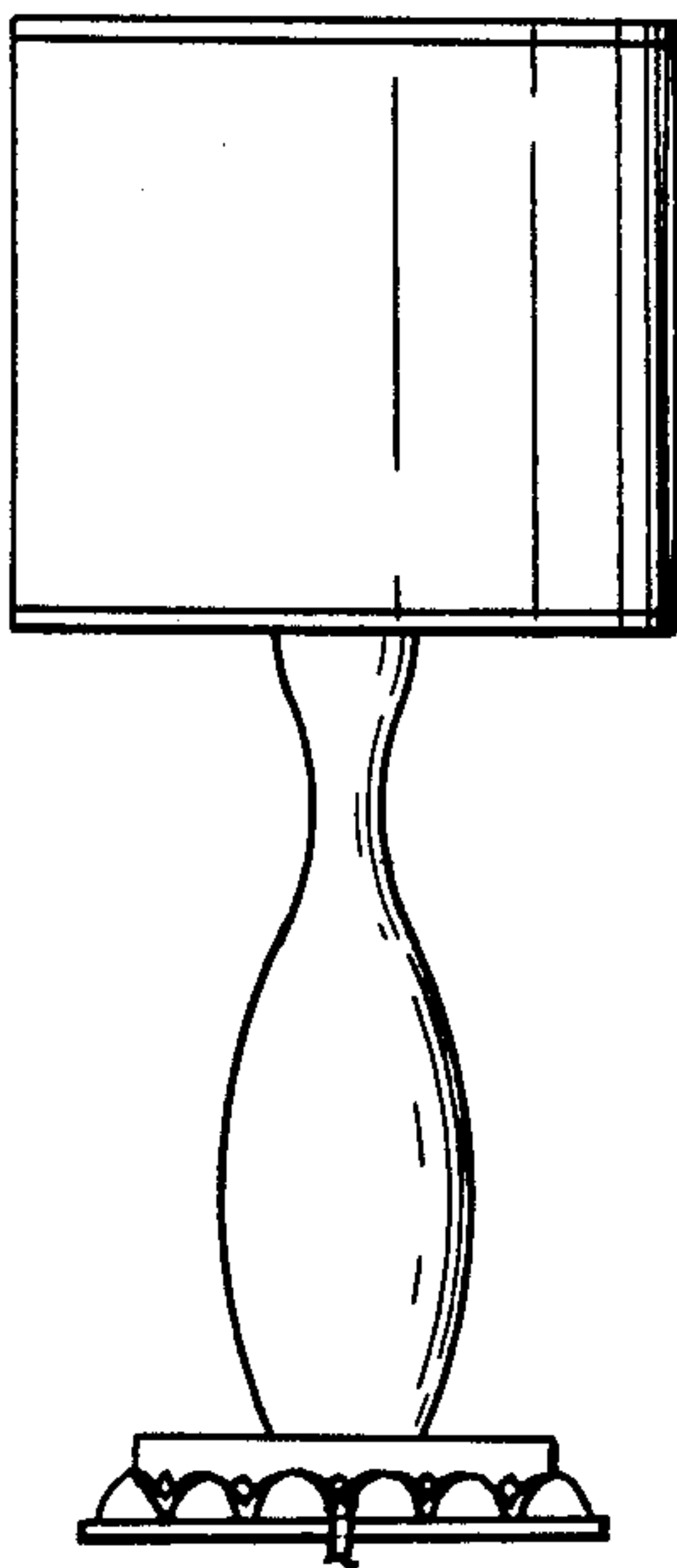
**FIG. 9**



**FIG. 10**

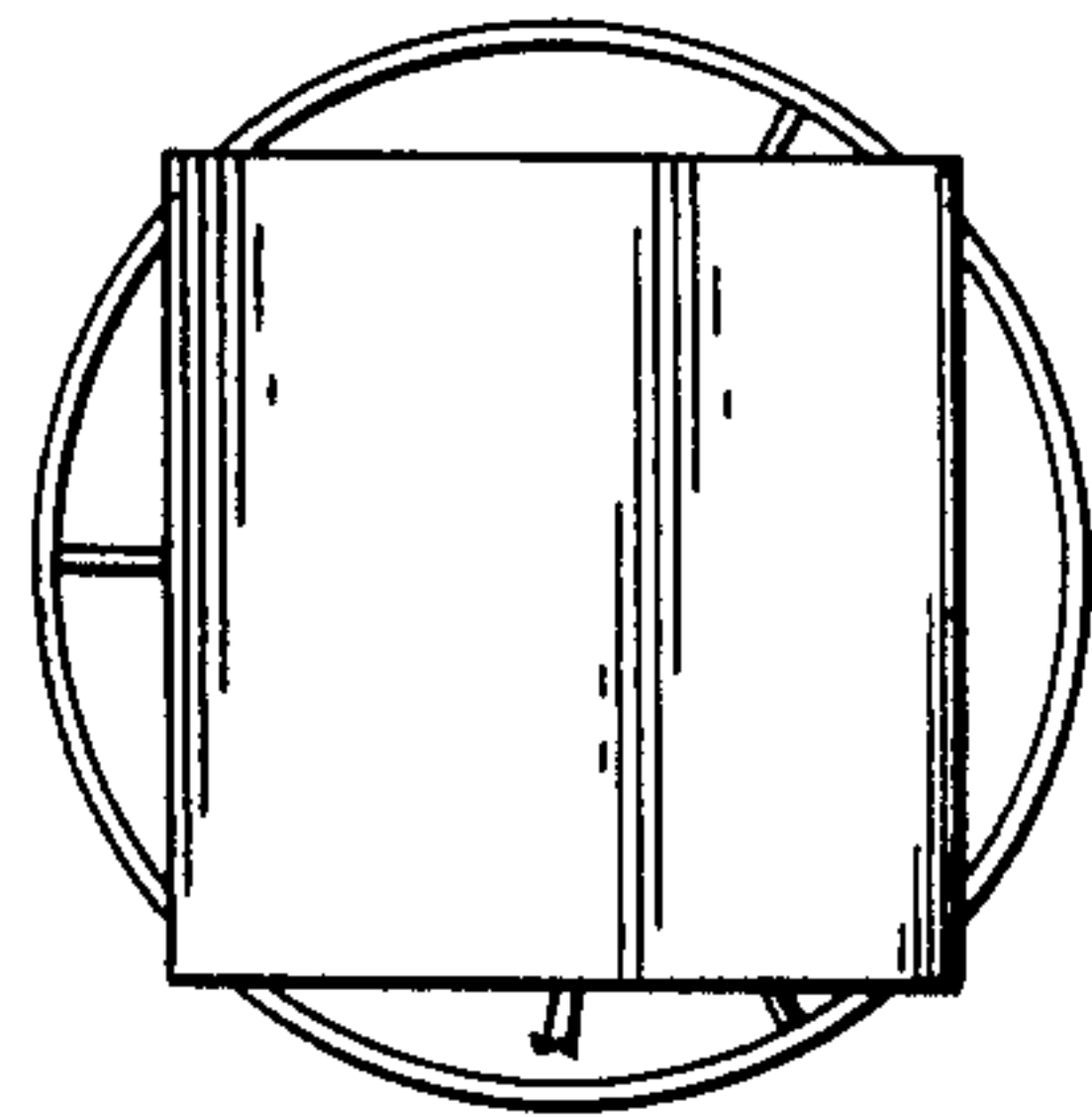


**FIG. 11**



**FIG. 12**

**FIG. 13**



**FIG. 14**

