

[54] SPEEDOMETER

[75] Inventor: Howard J. Rasmussen, Fox River Grove, Ill.

[73] Assignee: Stewart-Warner Corporation

[**] Term: 14 Years

[21] Appl. No.: 642,017

[22] Filed: Dec. 18, 1975

[51] Int. Cl. D10-04

[52] U.S. Cl. D10/98

[58] Field of Search D10/98, 97, 123, 124, D10/125, 127; 116/116; 73/185

[56] References Cited

U.S. PATENT DOCUMENTS

3,980,041 9/1976 Evans 116/116

OTHER PUBLICATIONS

American Bicyclist & Motorcyclist - Jan. 1974, p. 58, Speedometer, at top left.

American Bicyclist & Motorcyclist - Jan. 1974, p. 17, Speedometer (dials).

Primary Examiner—Nelson C. Holtje

Attorney, Agent, or Firm—Augustus G. Douvas

[57] CLAIM

The ornamental design for a speedometer, as shown.

DESCRIPTION

FIG. 1 is a left front perspective view of a speedometer showing my new design;

FIG. 2 is a top plan view thereof;

FIG. 3 is a front elevational view thereof;

FIG. 4 is a right side elevational view thereof;

FIG. 5 is a bottom plan view thereof; and

FIG. 6 is a rear elevational view thereof.

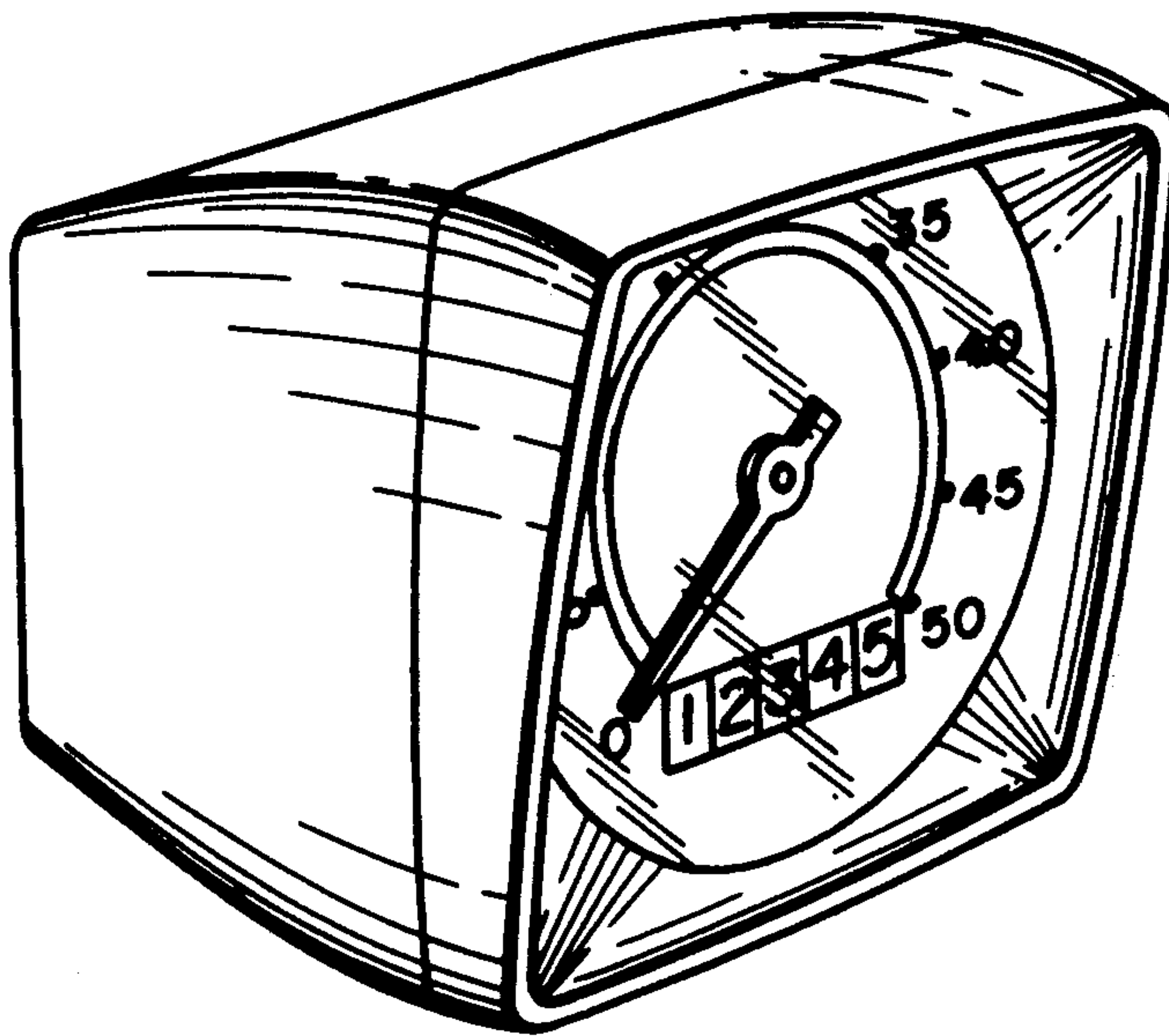

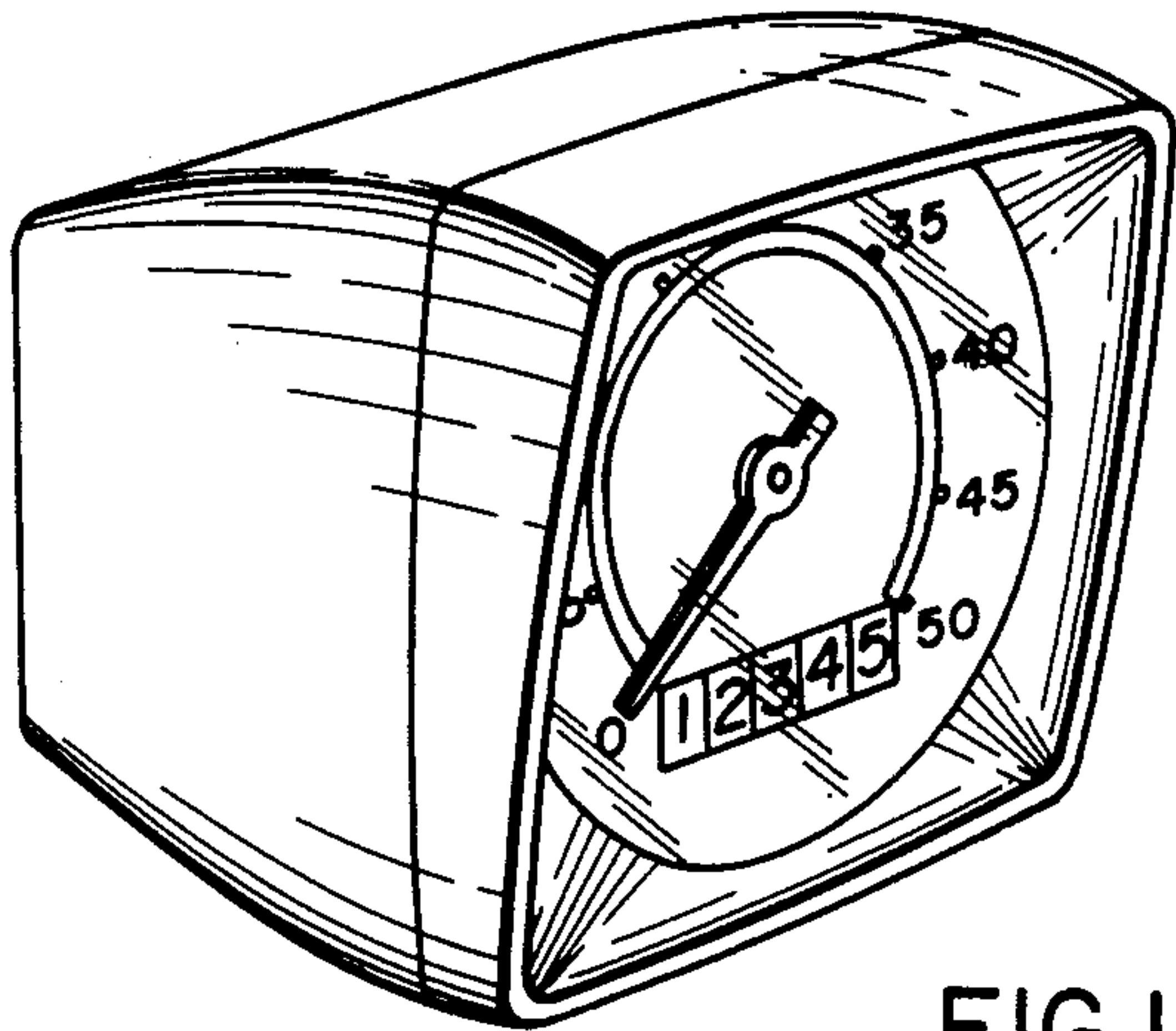

FIG. 1

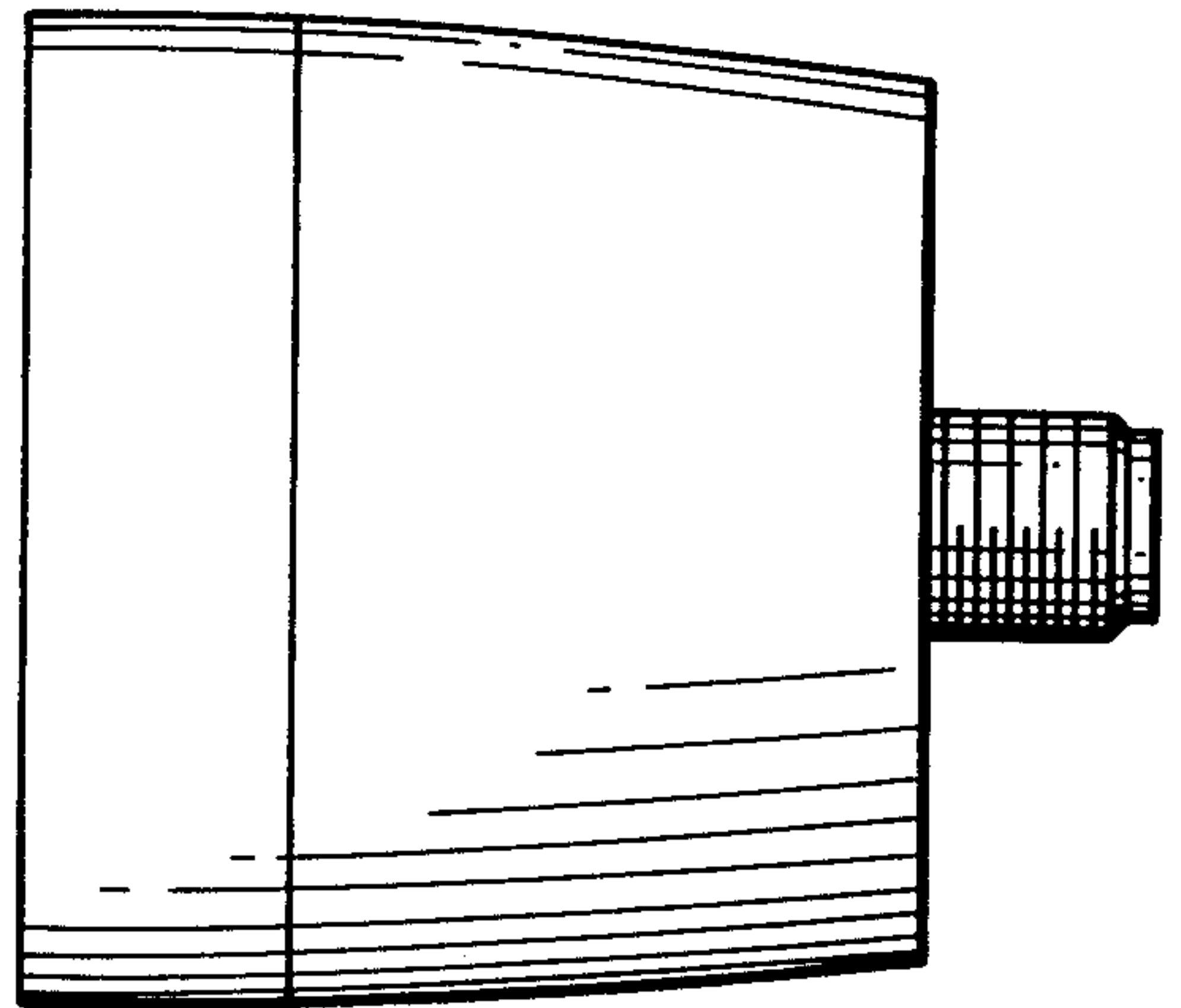

FIG. 2

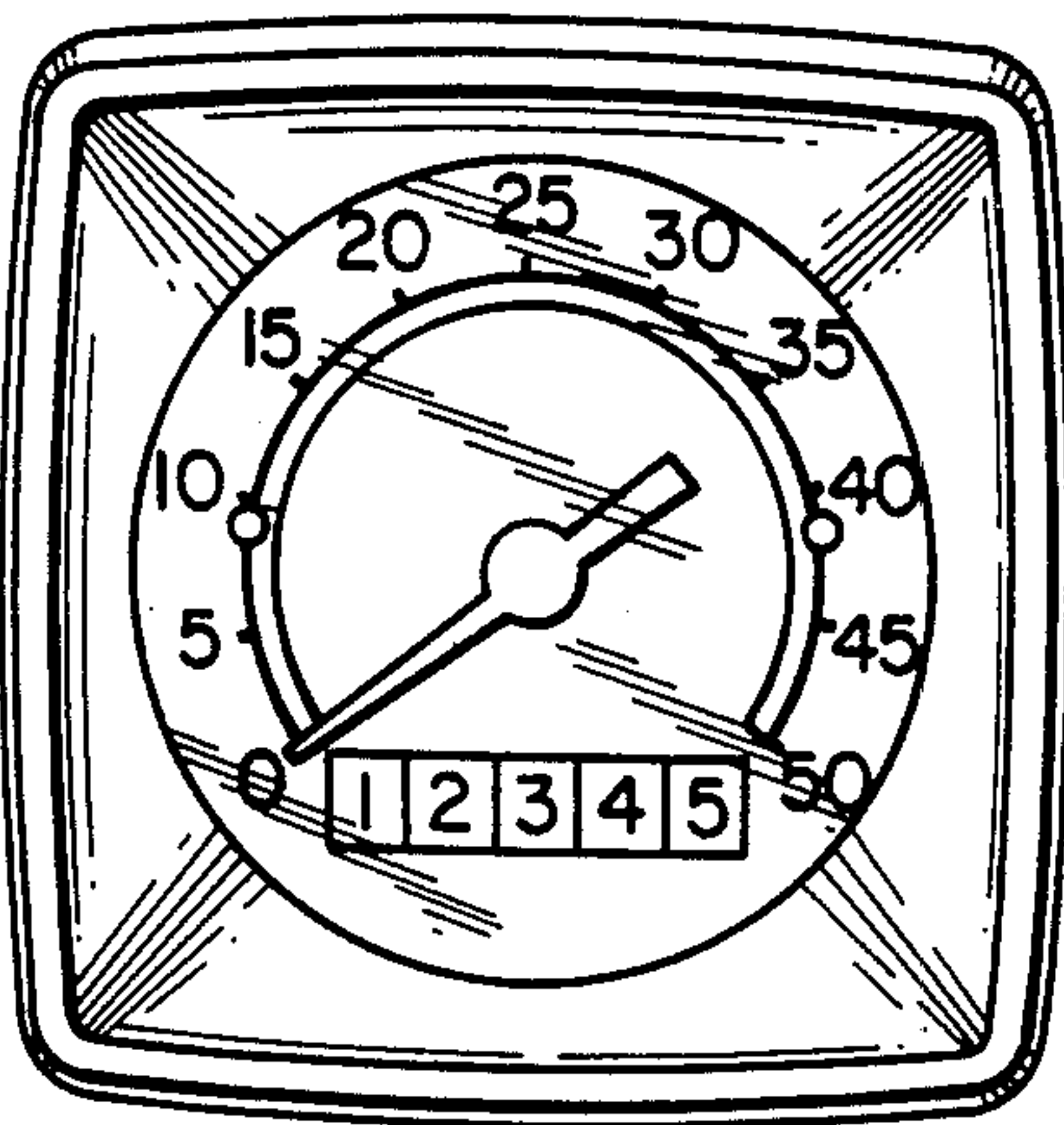

FIG. 3

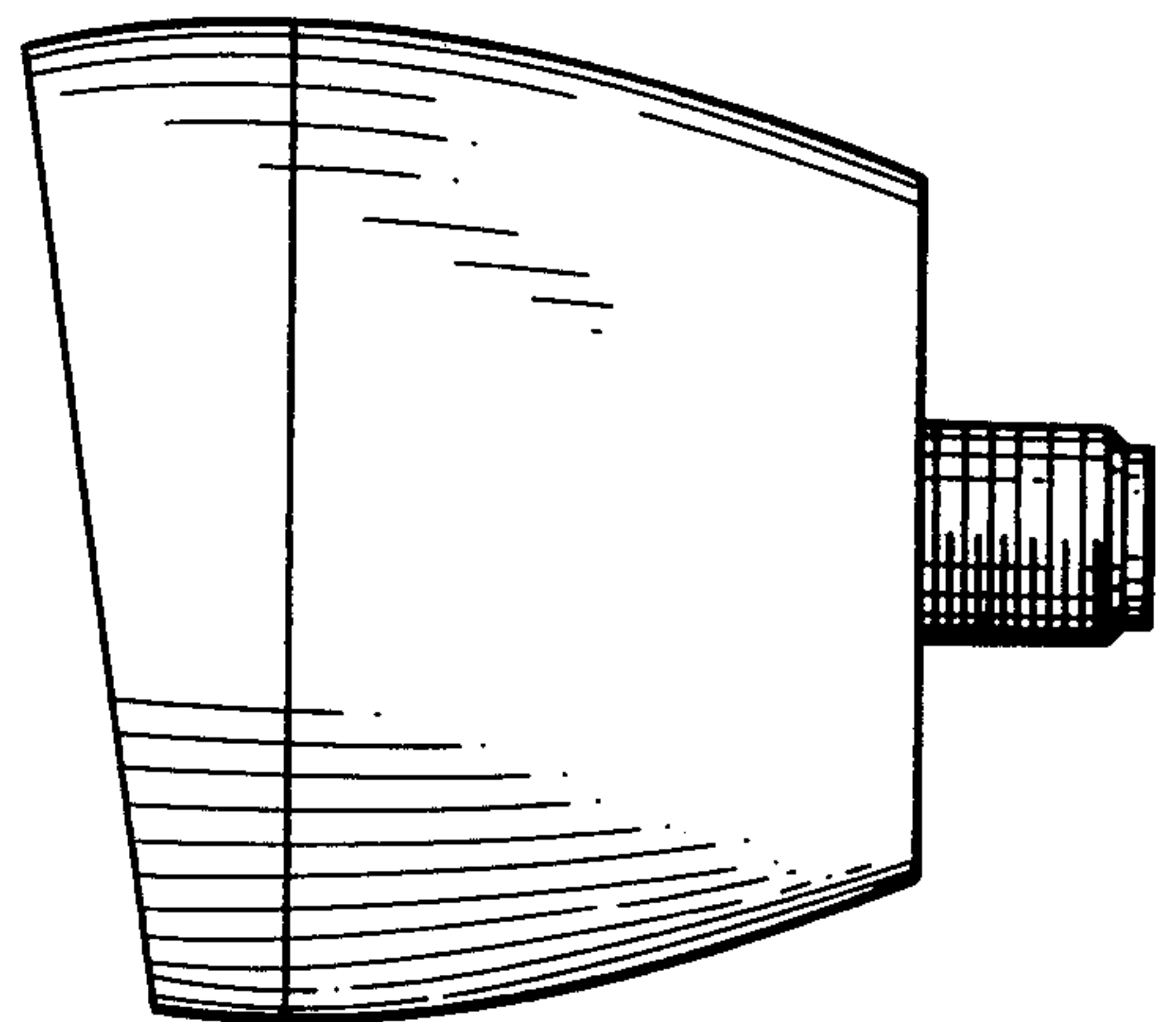

FIG. 4

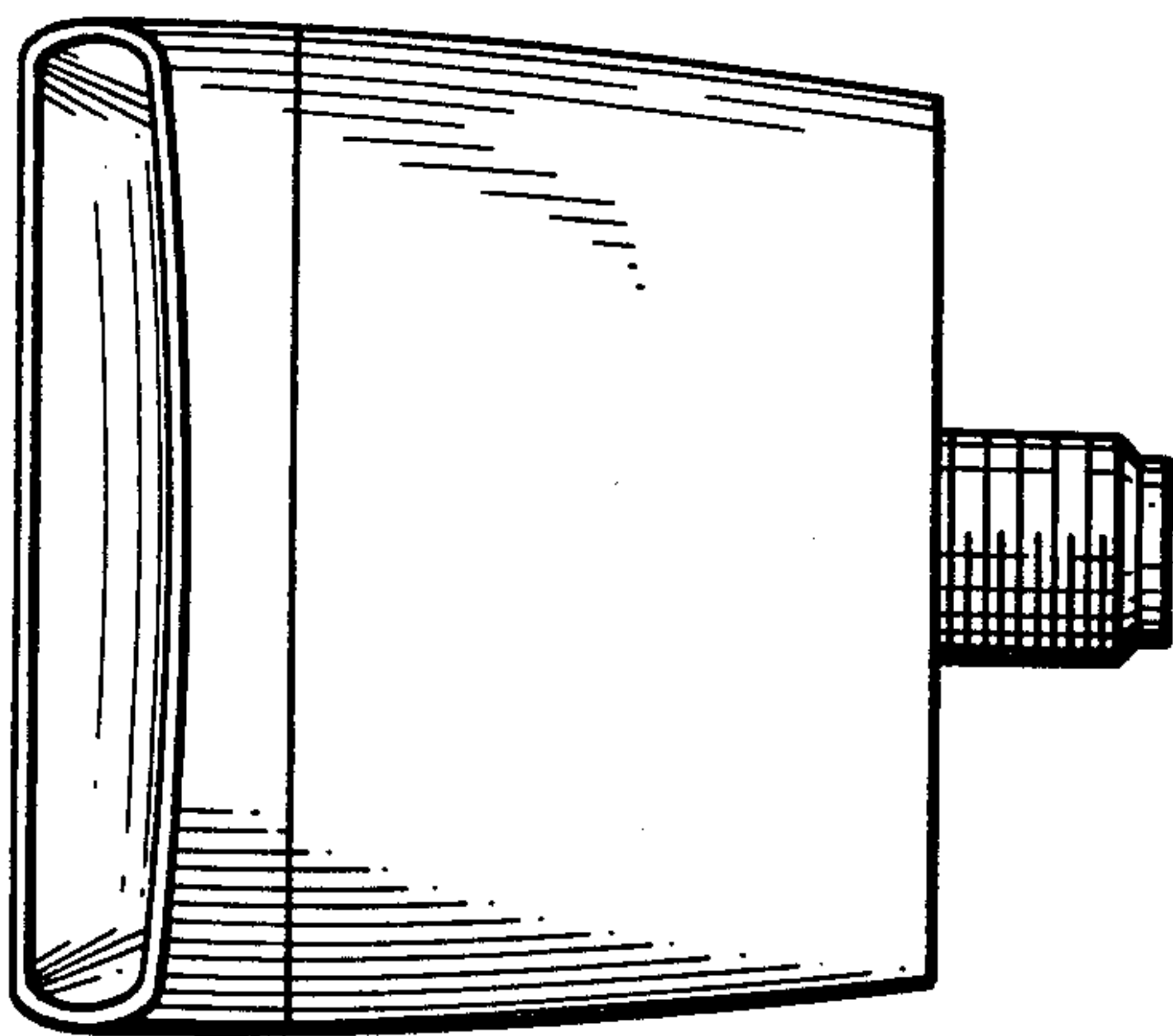

FIG. 5

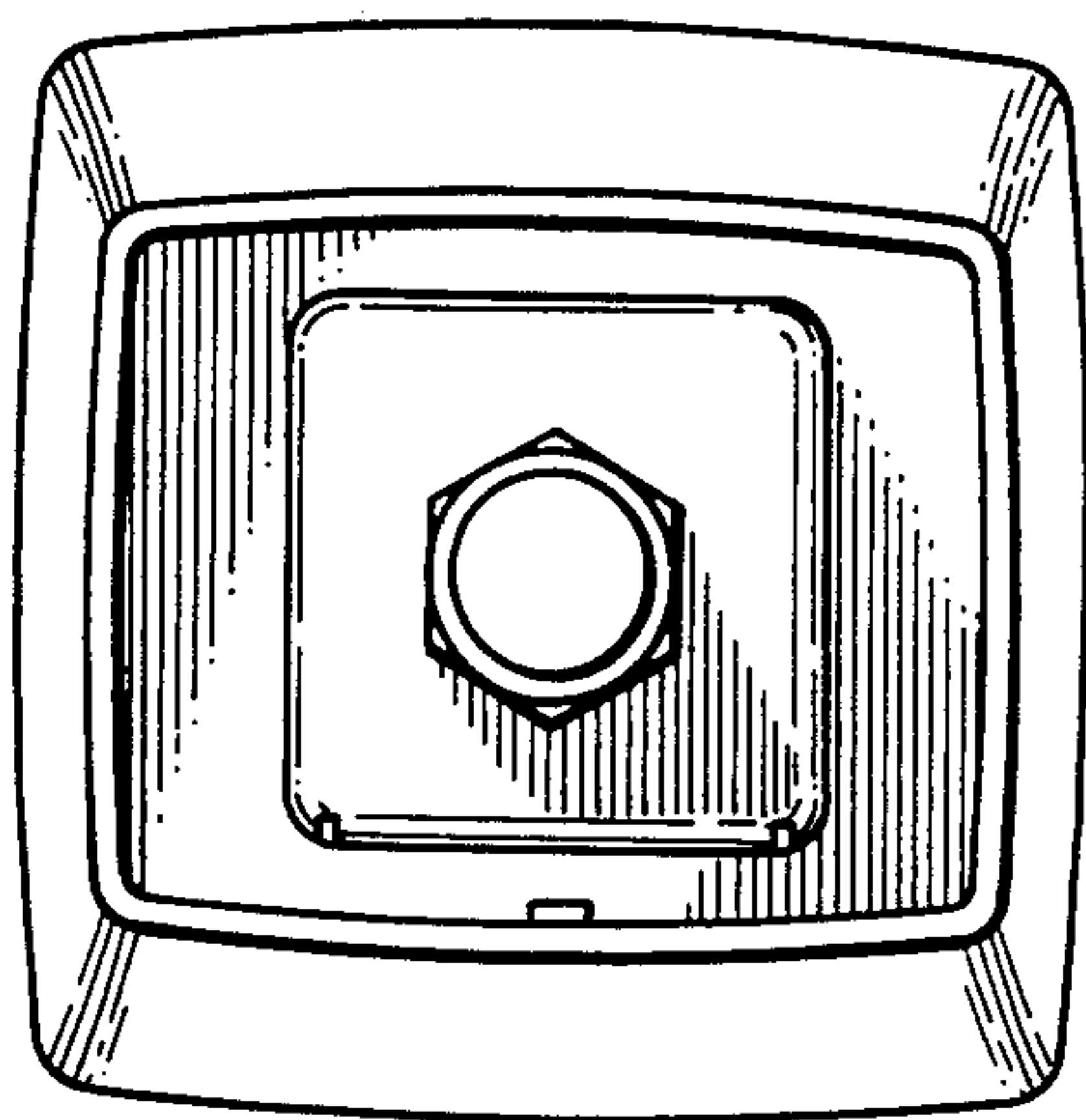

FIG. 6