

[54] CAR SEAT FOR A DOMESTIC ANIMAL

[76] Inventor: Anthony J. Russo, 144 Bentwillow Drive, Niles, Ohio 44446

[**] Term: 14 Years

[21] Appl. No.: 611,403

[22] Filed: Sept. 8, 1975

[51] Int. Cl. D30-06

[52] U.S. Cl. D30/41

[58] Field of Search D30/99, 41, 1; 119/1, 119/19, 17; 224/29 D, 42.42 R, 42.42 A, 42.45 B; D12/155-158; 5/118; D6/9

[56] References Cited

U.S. PATENT DOCUMENTS

1,912,514	6/1933	Curtis et al.	5/118
2,932,544	4/1960	Lambert	224/29 D
3,002,665	10/1961	Allen	224/42.42 A

3,219,232	11/1965	Wilson	D87/1 R
3,465,930	9/1969	La Croix	119/1
3,826,229	7/1974	Classe	119/17

Primary Examiner—Joel Stearman
Assistant Examiner—George P. Word
Attorney, Agent, or Firm—Michael Williams

[57] CLAIM

The ornamental design for a car seat for a domestic animal, substantially as shown and described.

DESCRIPTION

FIG. 1 is a perspective view of a car seat for a domestic animal, showing my new design, FIG. 2 is a right side elevational view thereof, the opposite side being similar; FIG. 3 is a top plan view; FIG. 4 is a rear elevational view; FIG. 5 is a cross-sectional view taken along line 5-5 of FIG. 2; and FIG. 6 is a bottom plan view.

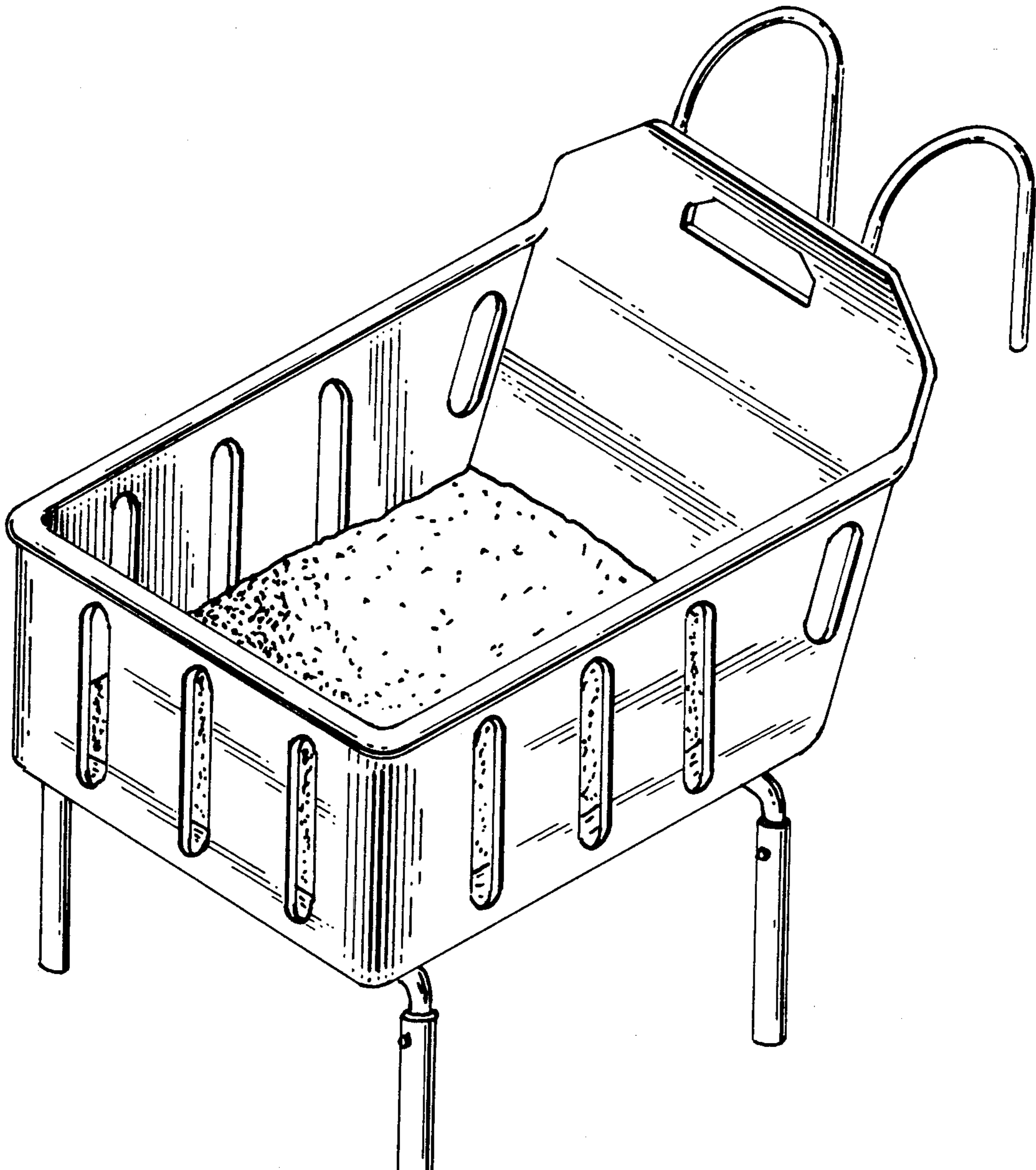

FIG. 1.

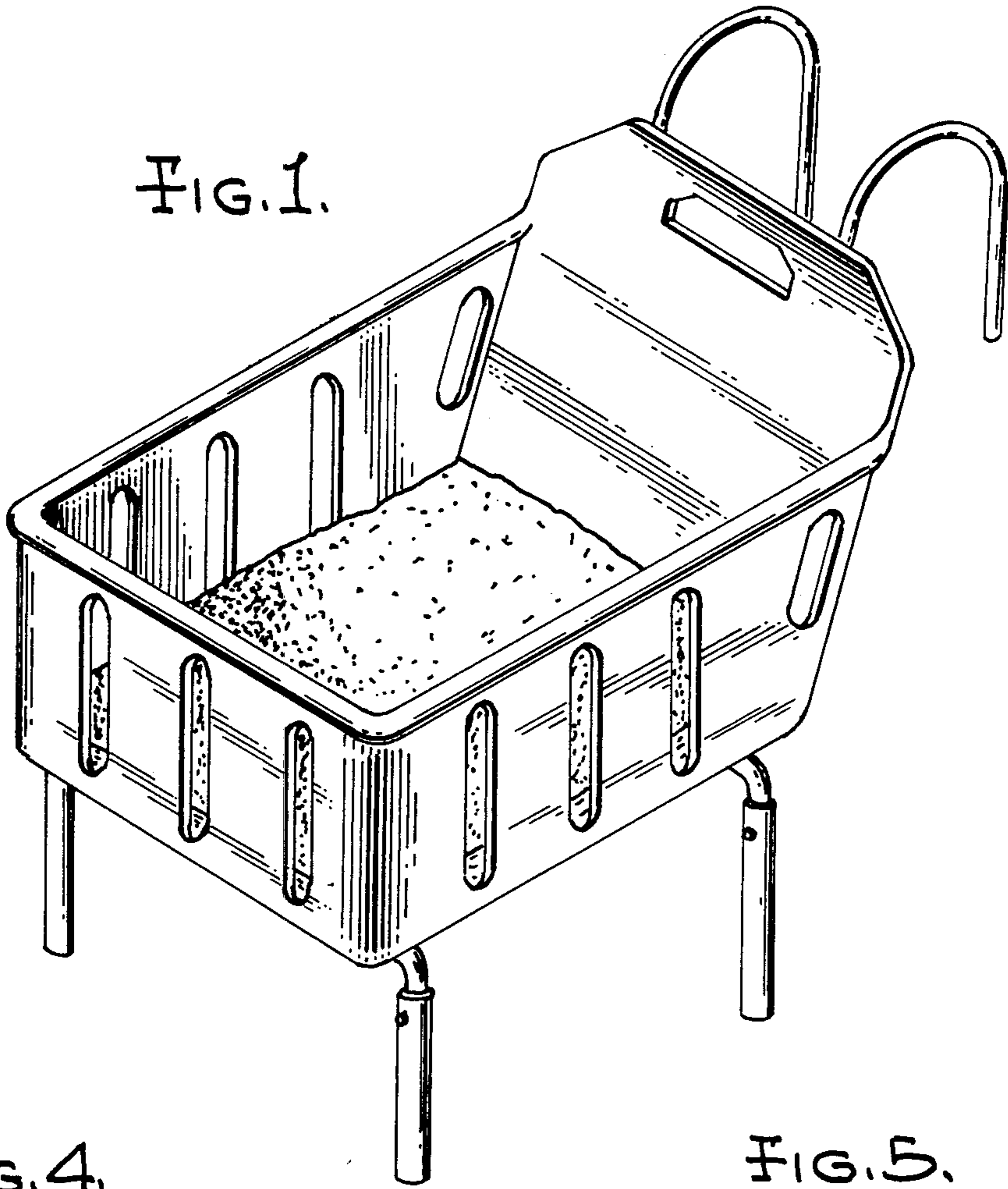

FIG. 4.

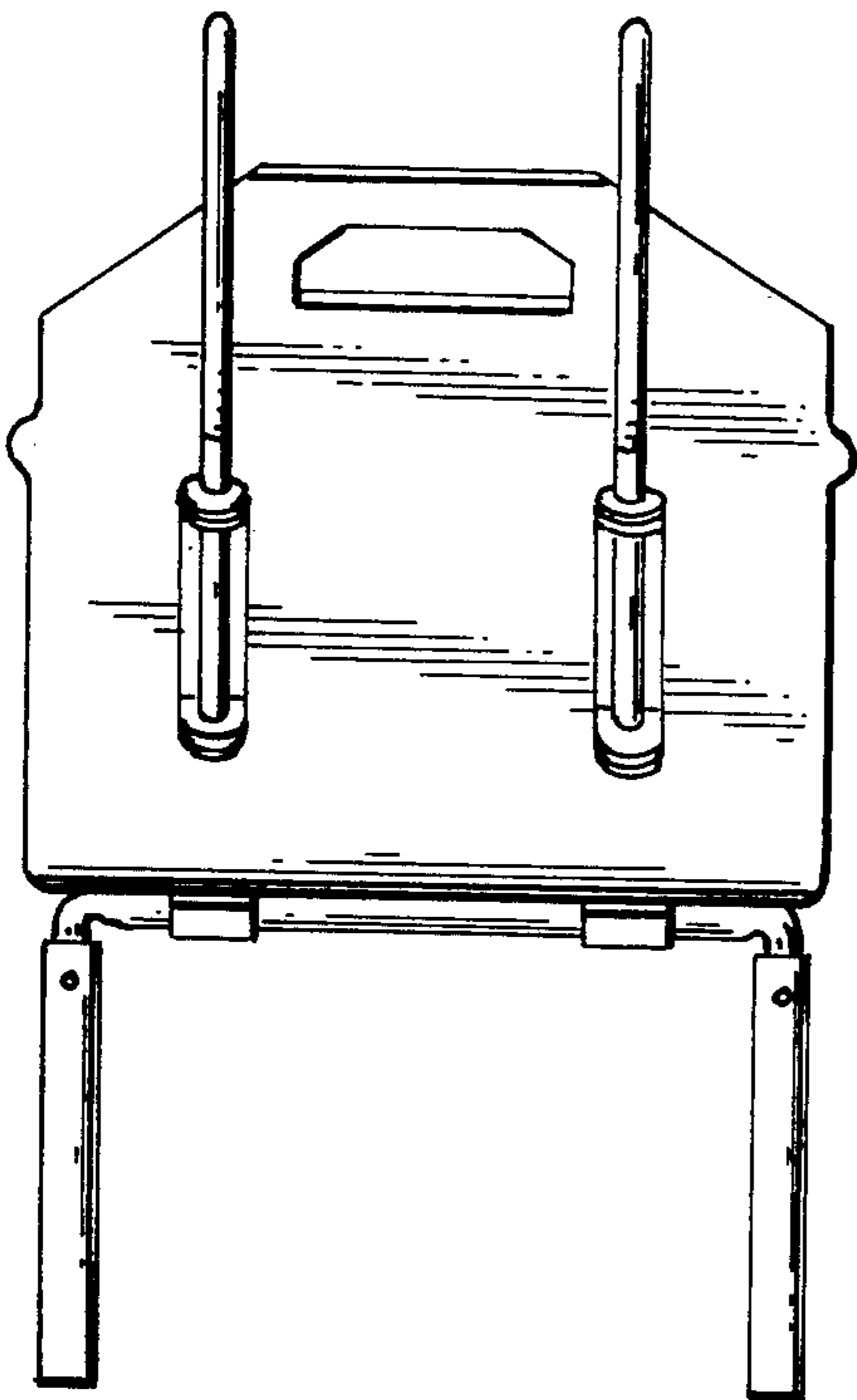
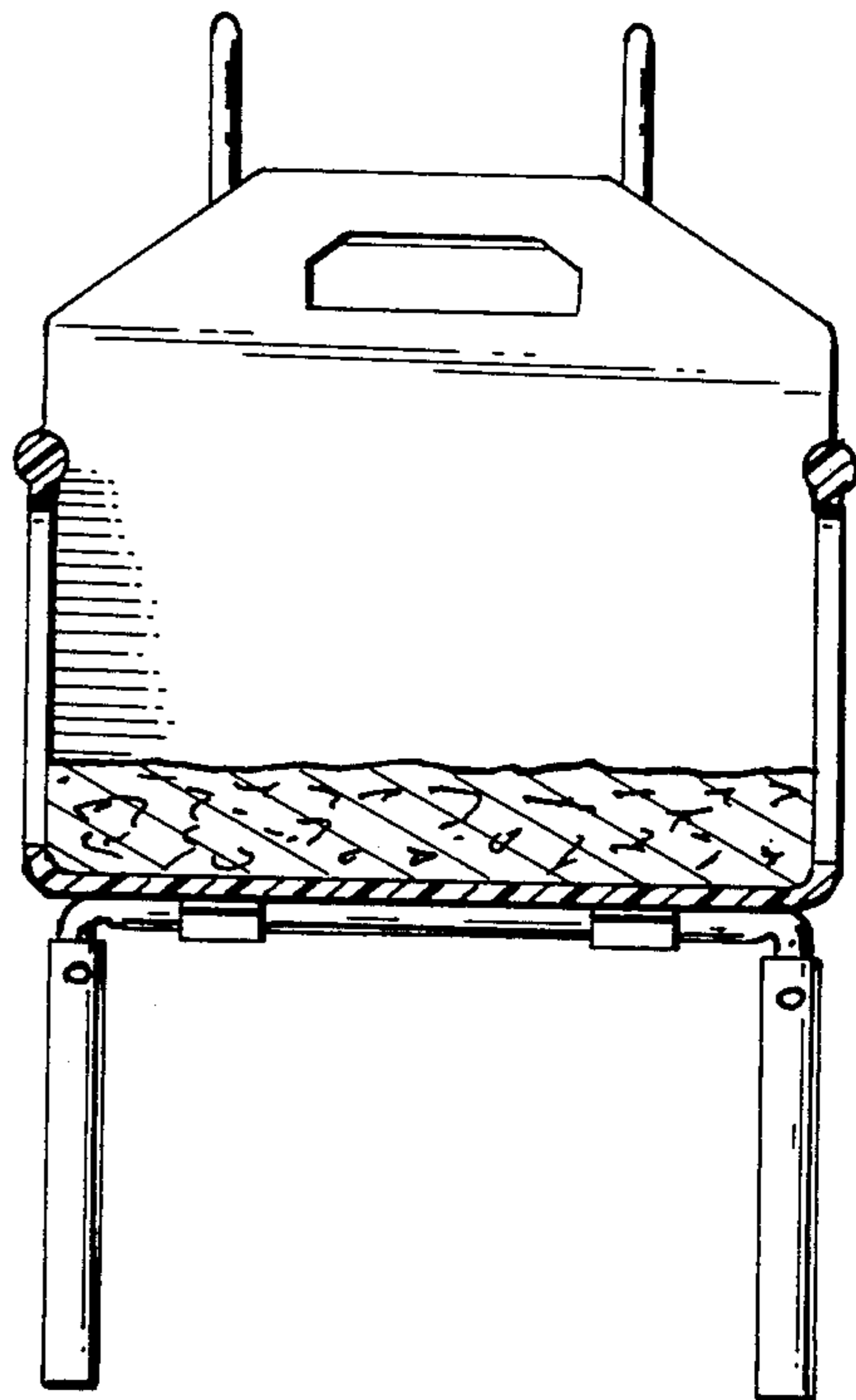

FIG. 5.



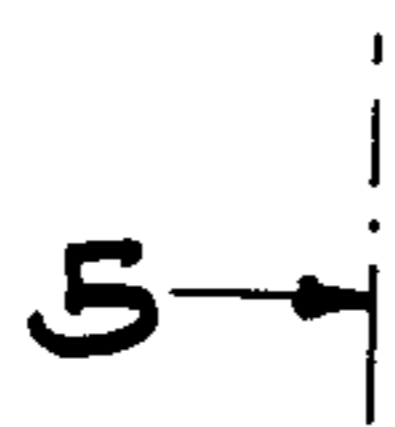
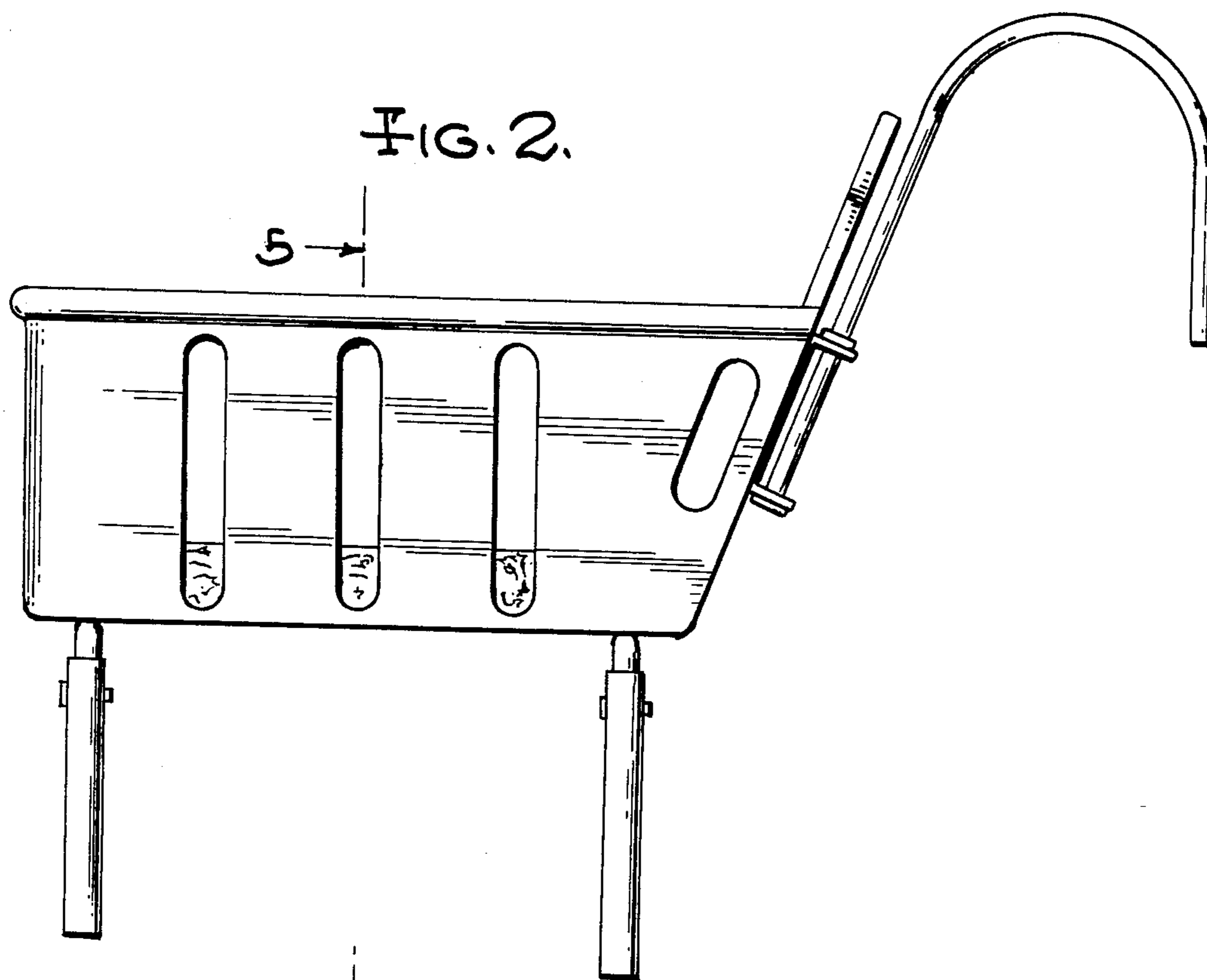

FIG. 3.

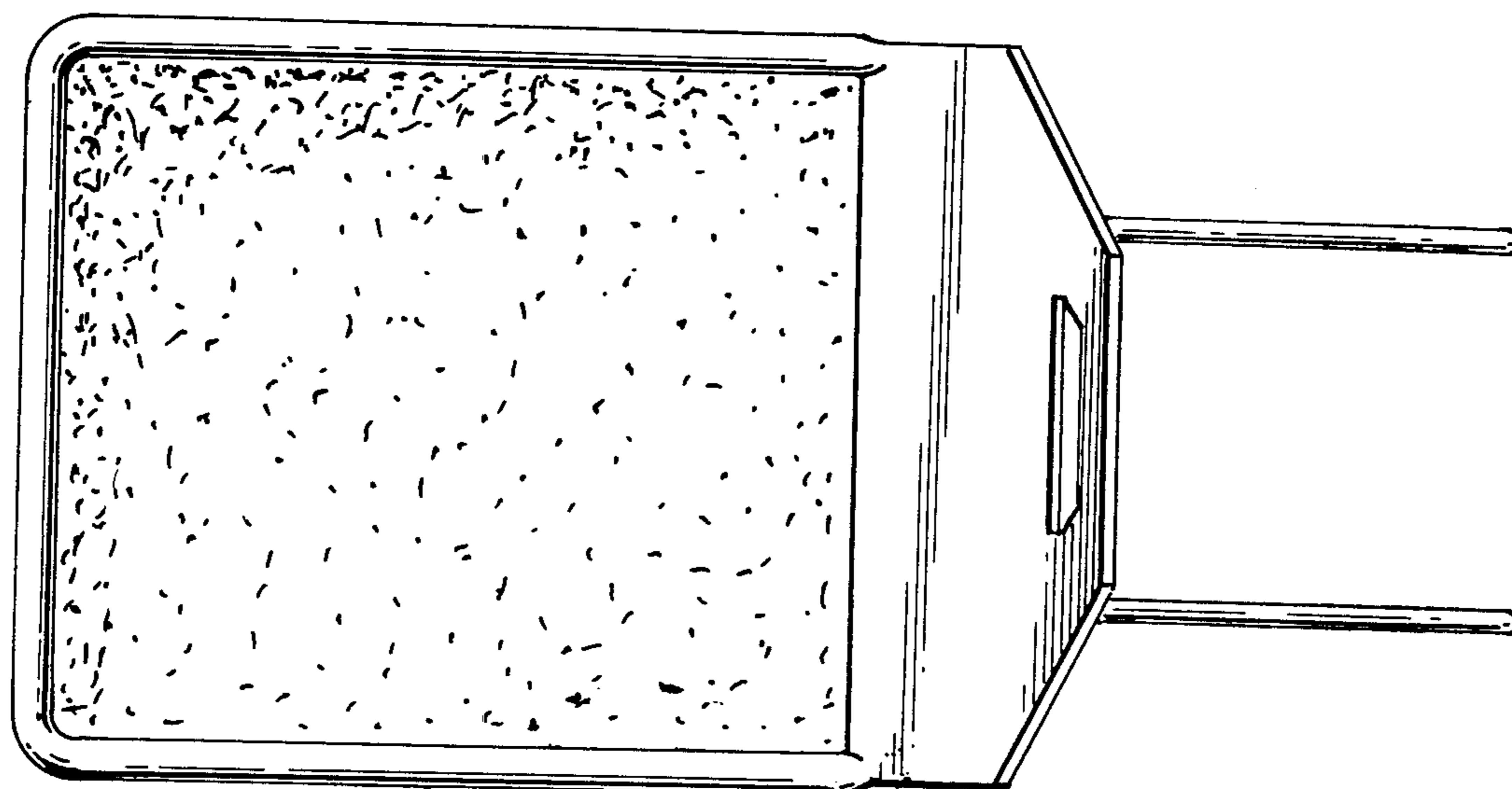

FIG. 6.

