

- [54] PICTURE FRAME OR THE LIKE
- [75] Inventor: Gerald M. Grusin, Chicago, Ill.
- [73] Assignee: Dart Industries Inc., Los Angeles, Calif.
- [**] Term: 14 Years
- [21] Appl. No.: 631,002
- [22] Filed: Nov. 12, 1975
- [51] Int. Cl. D6—07
- [52] U.S. Cl. D6/235
- [58] Field of Search D6/232-246;
D25/74, 76, 79; D56/4 B; 40/152-152.1,
154-155, 157, 158 A, 10, 156

[56] **References Cited**

U.S. PATENT DOCUMENTS

- D. 92,400 6/1934 Hoeflich D6/235
- D. 195,025 4/1963 Jefferson D25/79

D. 212,342 10/1968 Rote D56/4 B

Primary Examiner—Nelson C. Holtje
Assistant Examiner—C. A. Rademaker
Attorney, Agent, or Firm—Leigh B. Taylor

[57] **CLAIM**

The ornamental design for a picture frame or the like, substantially as shown.

DESCRIPTION

FIG. 1 is a front perspective view of the picture frame or the like showing my new design;
FIG. 2 is a top plan view thereof;
FIG. 3 is a bottom plan view thereof;
FIG. 4 is front elevational view thereof;
FIG. 5 is rear elevational view thereof;
FIG. 6 is another front perspective view thereof showing the design in an alternate standing position;
FIG. 7 is a right side elevational view of FIG. 6; and
FIG. 8 is a right side elevational view of FIG. 5.

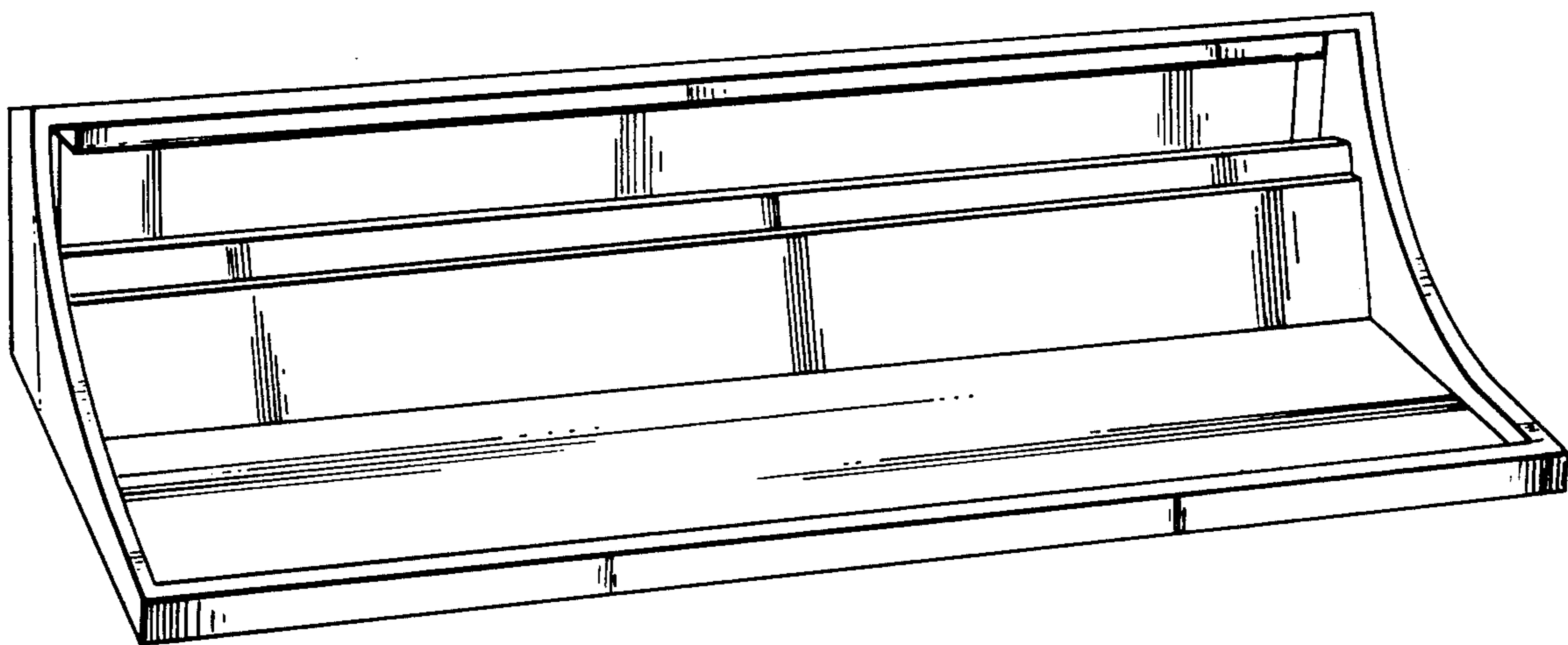

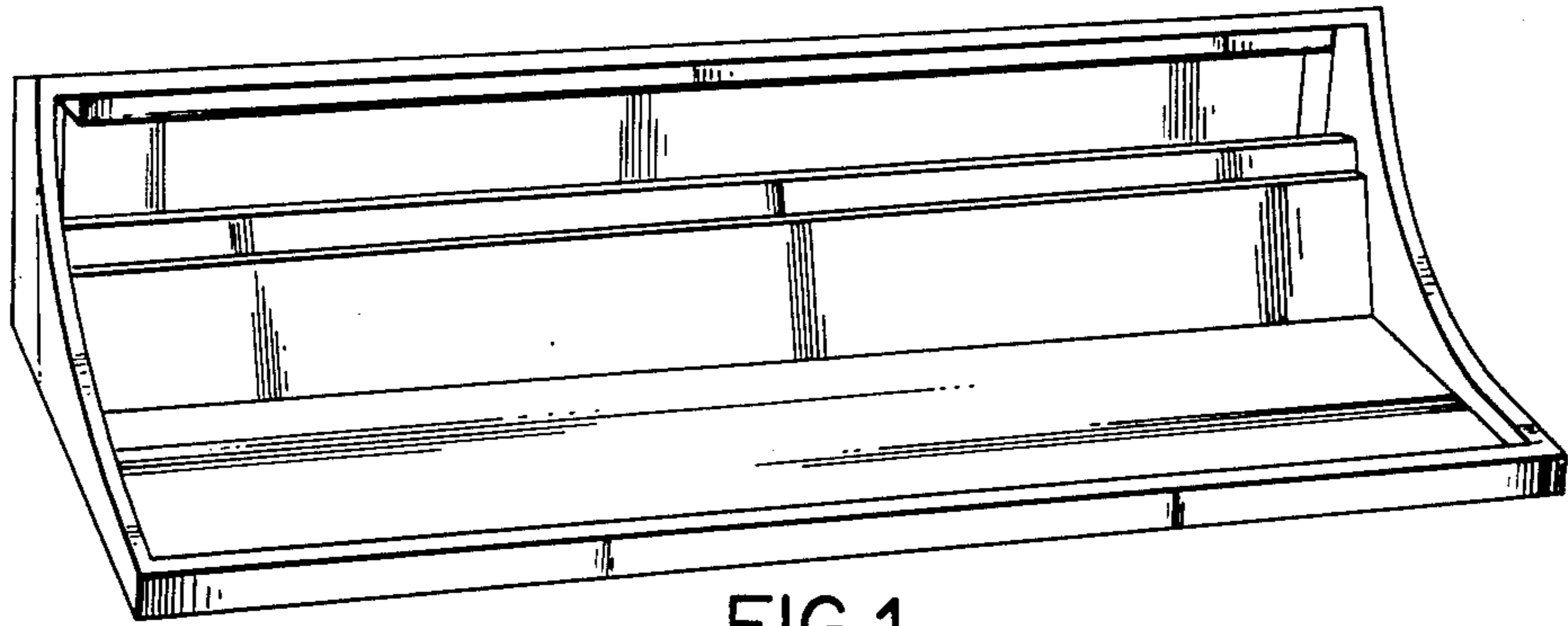

FIG. 1

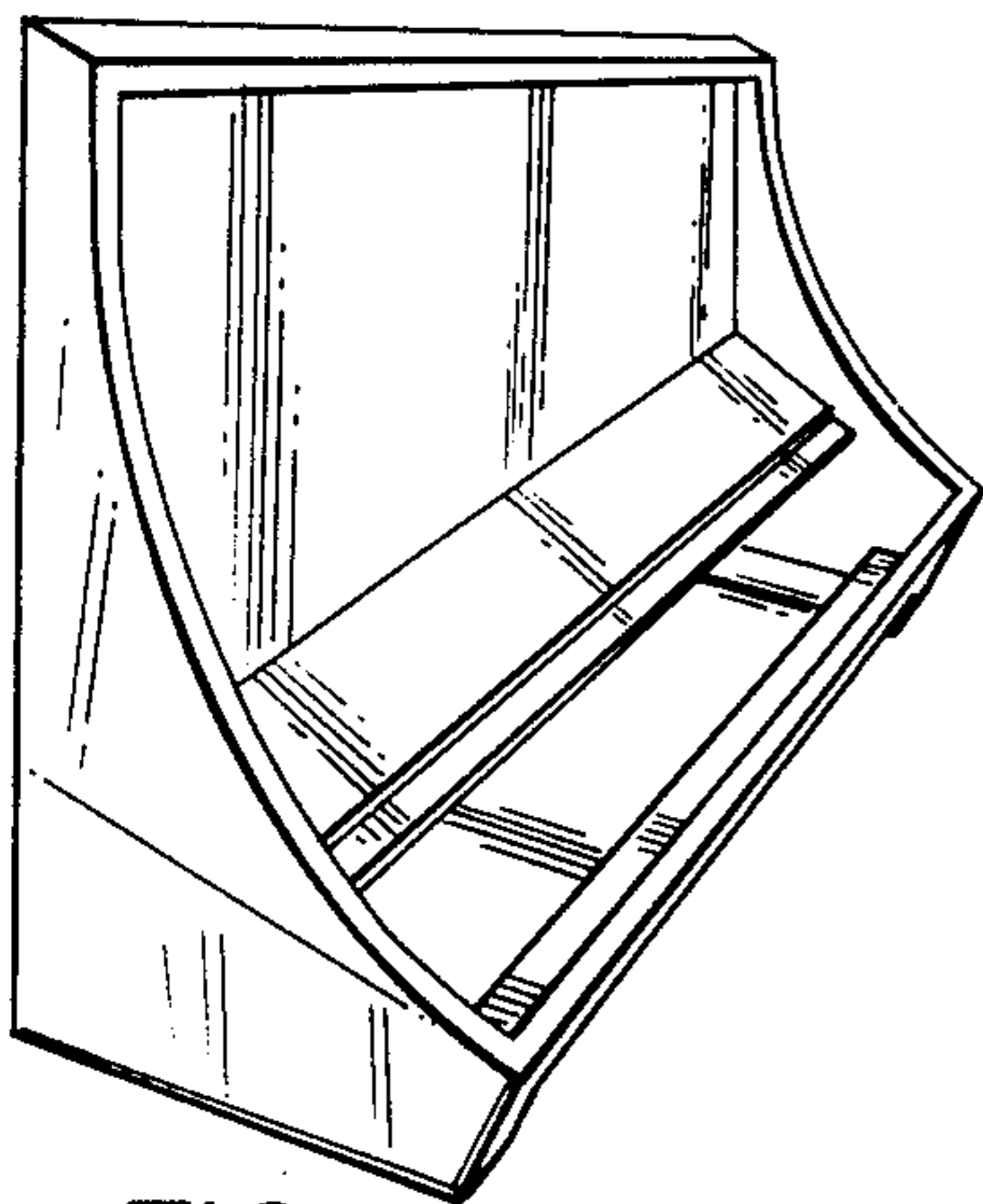

FIG. 6

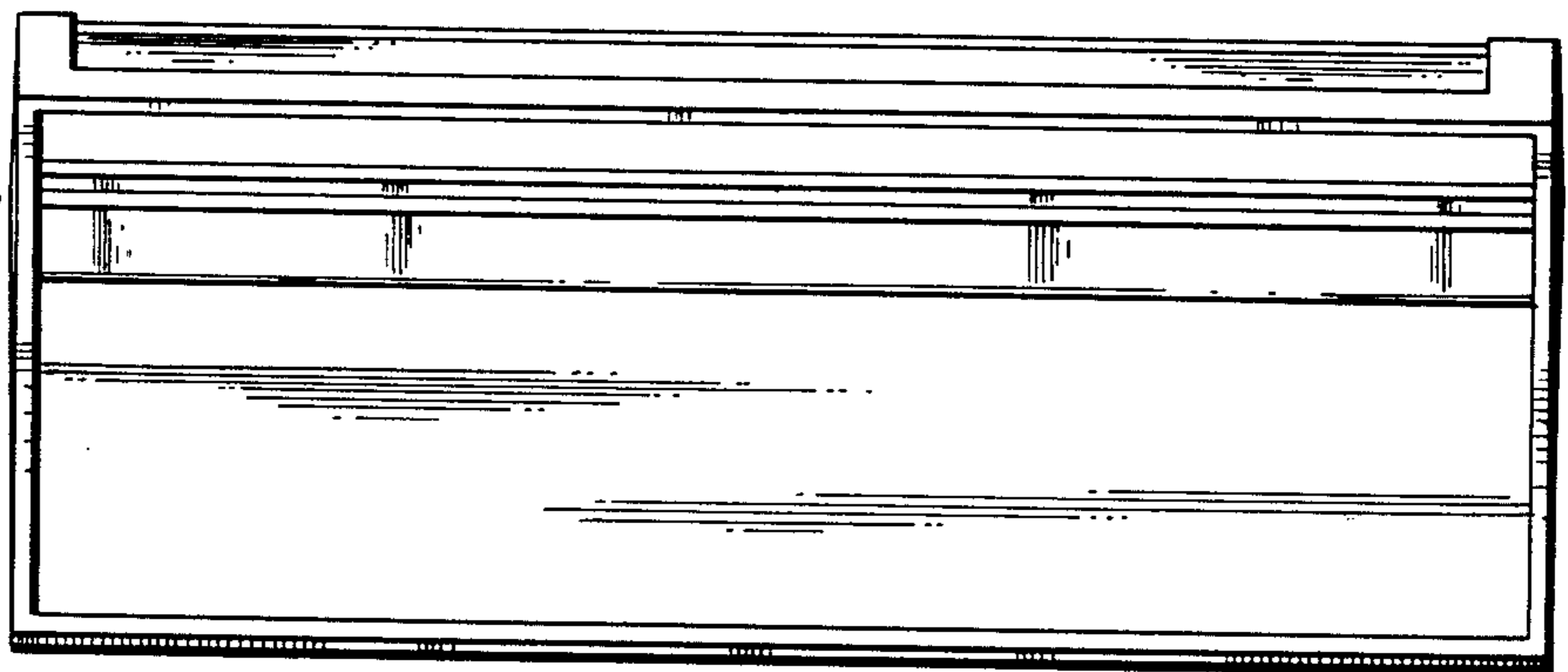

FIG. 2

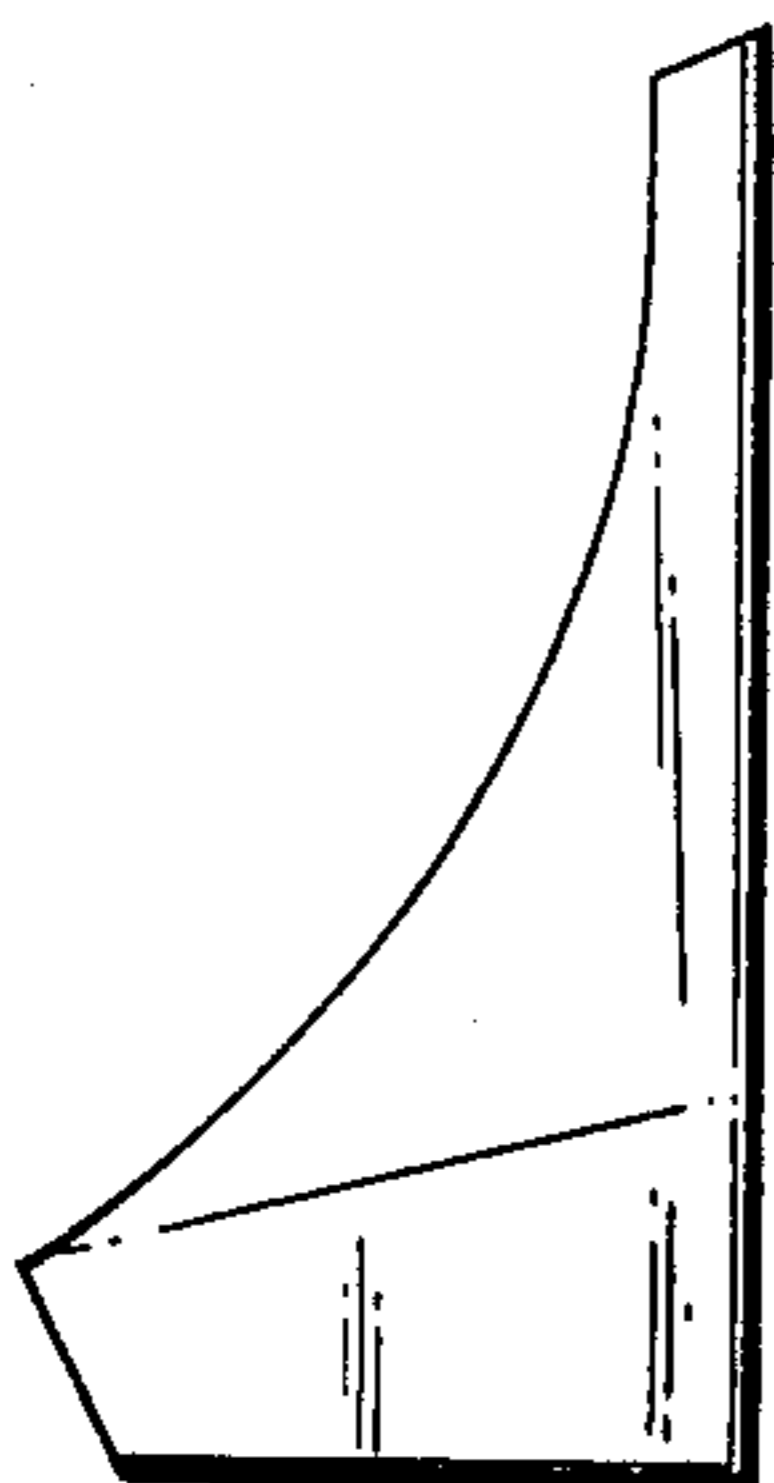

FIG. 7

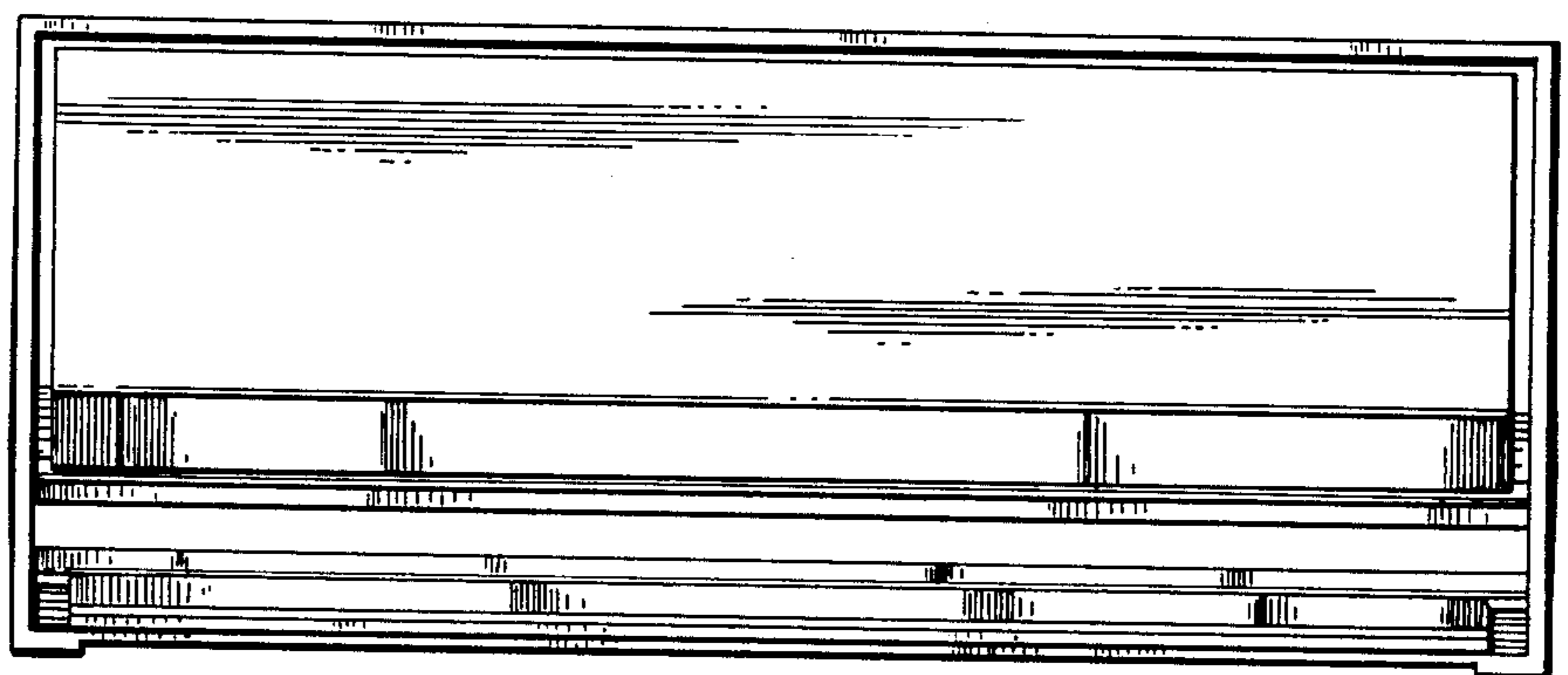

FIG. 3

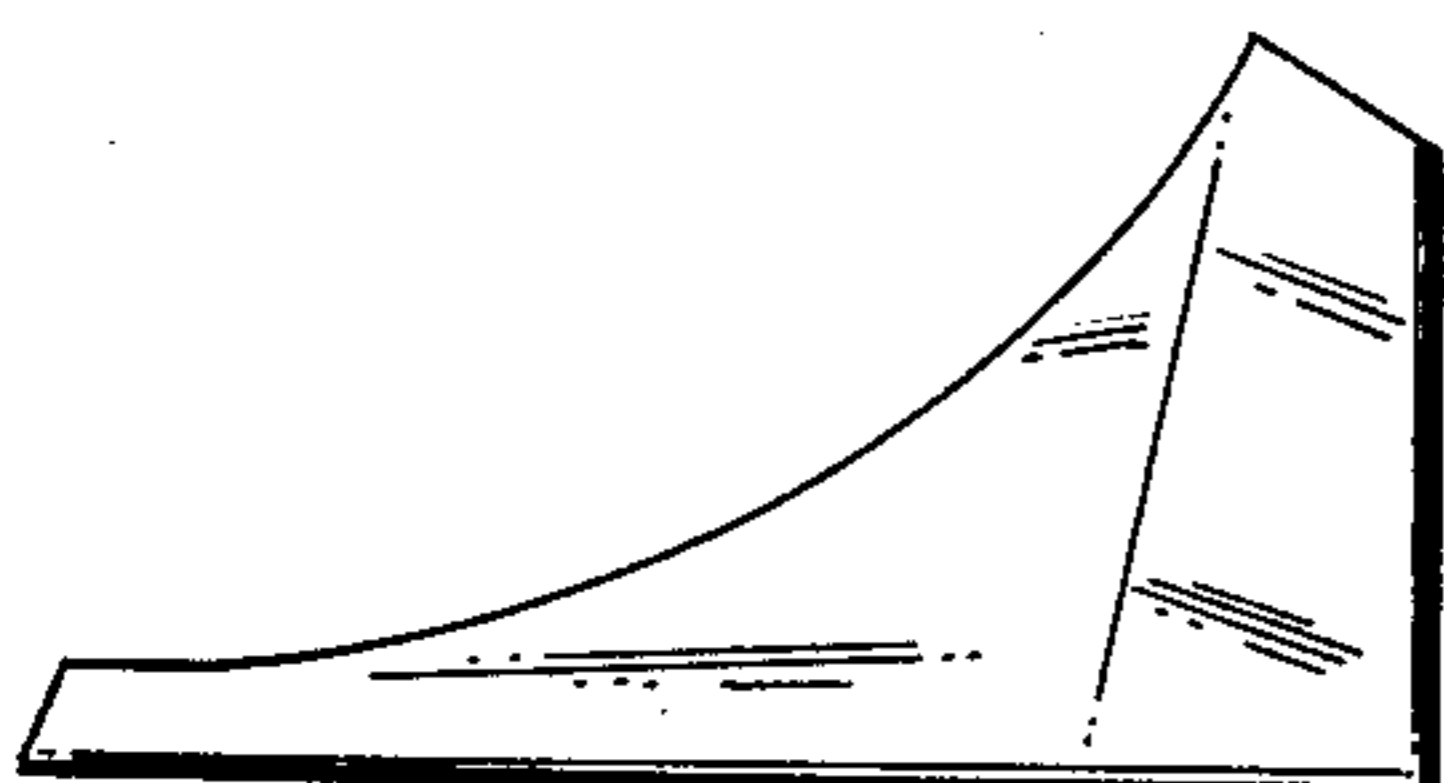

FIG. 8

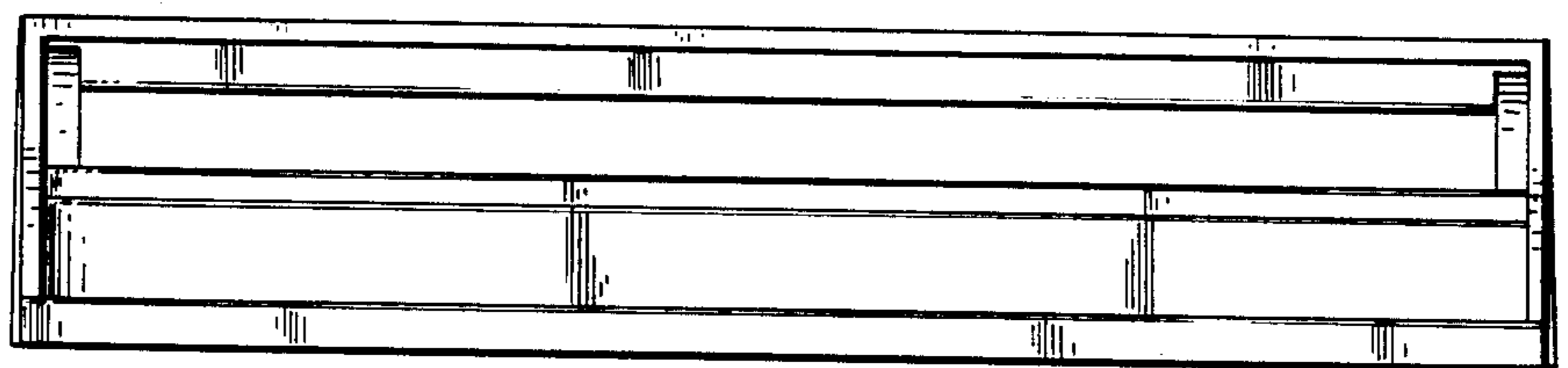

FIG. 4

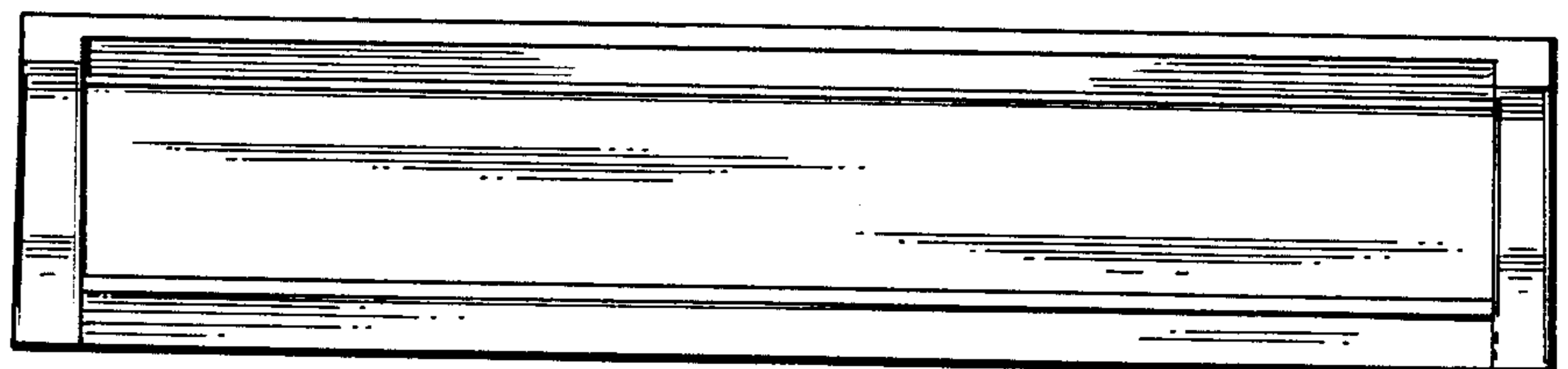

FIG. 5