

United States Patent [19]

Reiss

[11] **Des. 245,464**

[45] ** **Aug. 23, 1977**

[54] **PROTECTIVE SHIELD FOR USE WITH RADIOACTIVE MATERIALS**

[76] Inventor: **Meyer M. Reiss, 29 Lake Ave., Center Moriches, N.Y. 11931**

[**] Term: **14 Years**

[21] Appl. No.: **658,511**

[22] Filed: **Feb. 17, 1976**

[51] Int. Cl. **D6-99**

[52] U.S. Cl. **D6/27**

[58] Field of Search **D6/85, 20-31, D6/181-186, 172, 173; D32/2 B; D26/5 C**

[56] **References Cited**

U.S. PATENT DOCUMENTS

2,370,683 3/1945 Palma **D32/2 B X**
D. 232,546 8/1974 Gentelli et al. **D32/2 B**

D. 236,045 7/1975 Petrie **D6/27**

Primary Examiner—Bruce W. Dunkins
Attorney, Agent, or Firm—Charles E. Temko

[57] **CLAIM**

The ornamental design for a protective shield for use with radioactive materials, substantially as shown.

DESCRIPTION

FIG. 1 is a view in perspective of a protective shield for use with radioactive materials showing my new design; FIG. 2 is a side elevational view thereof on an enlarged scale, the opposite side being the same; FIG. 3 is a top plan view thereof on an enlarged scale; FIG. 4 is a rear elevational view thereof on an enlarged scale; FIG. 5 is a front elevational view thereof on an enlarged scale; and FIG. 6 is a bottom plan view thereof.

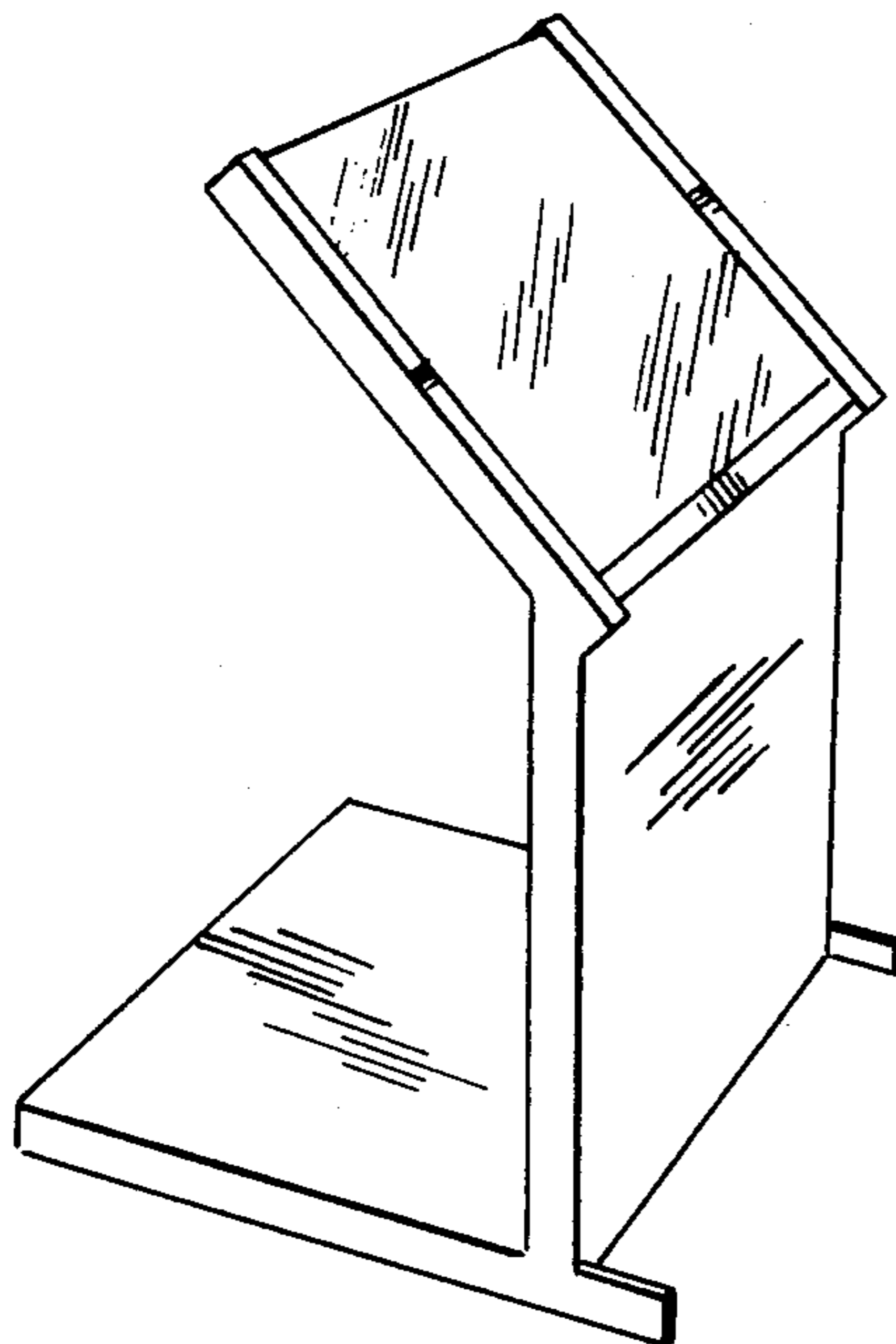

FIG. 1

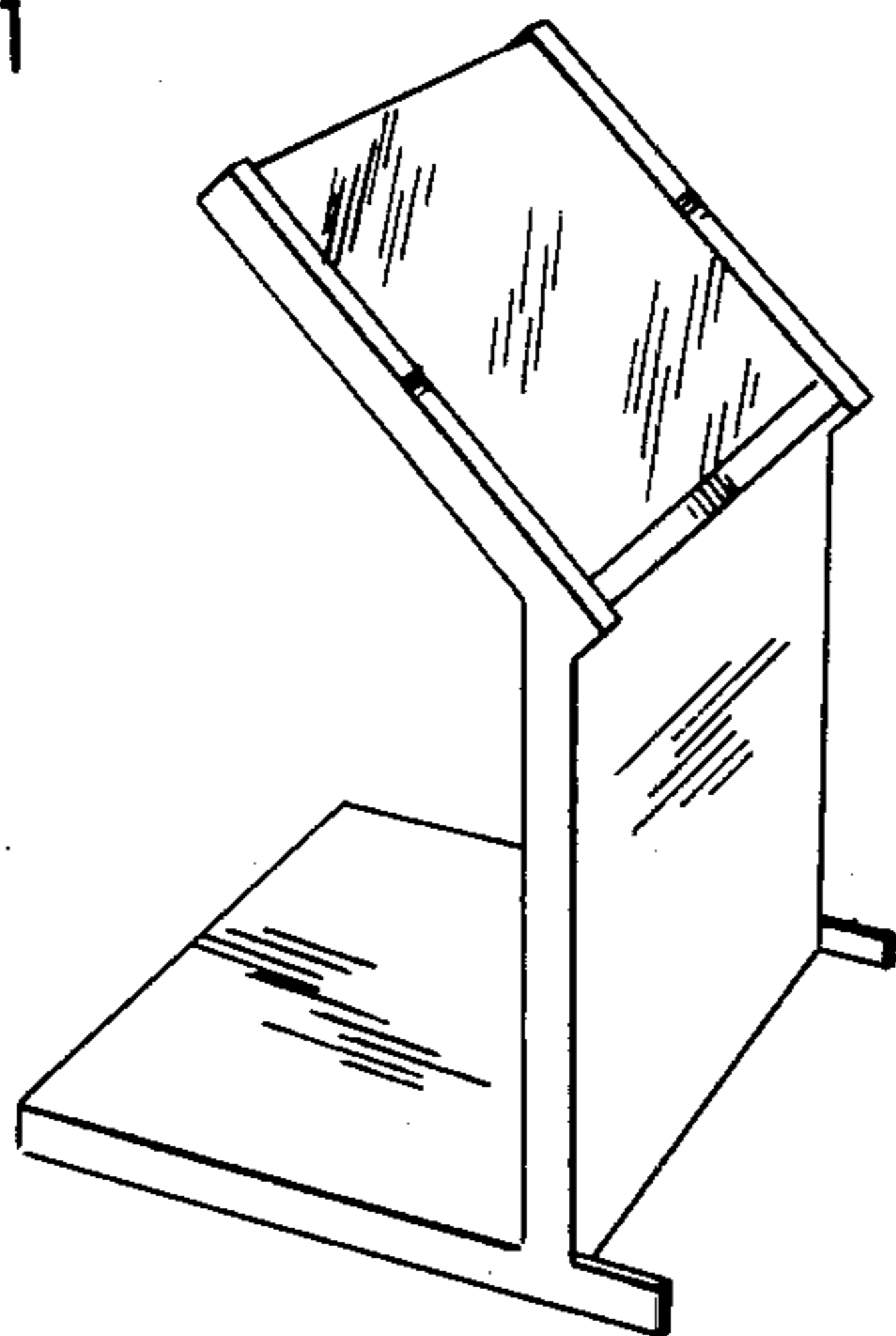

FIG. 4

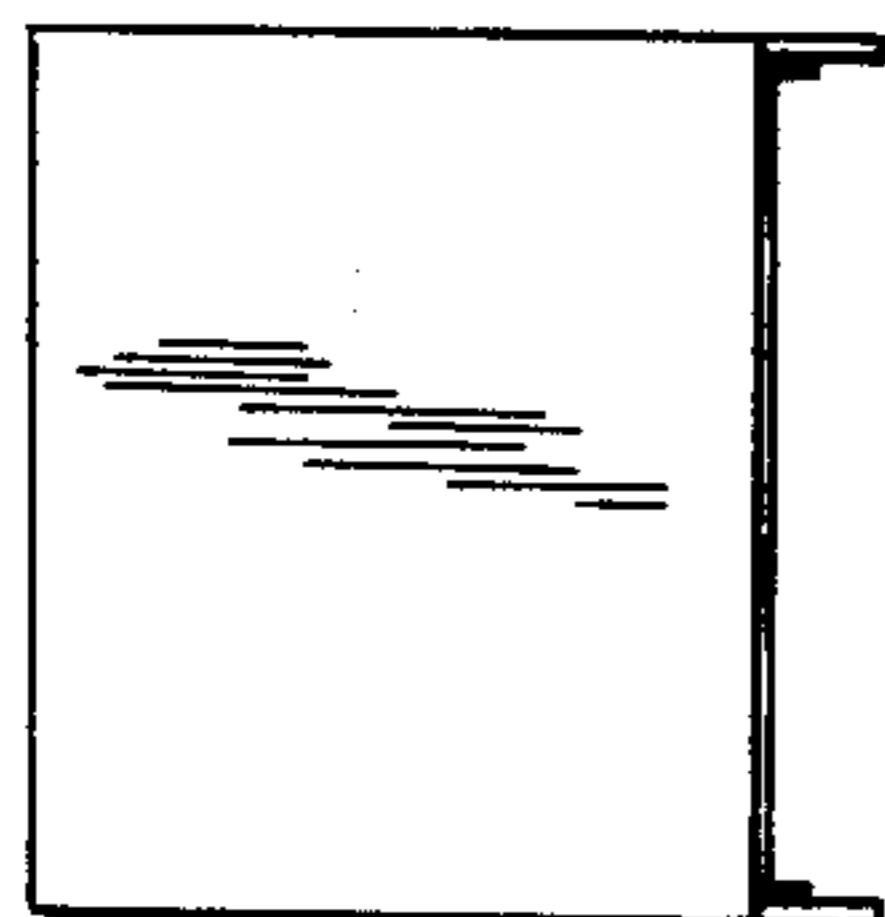
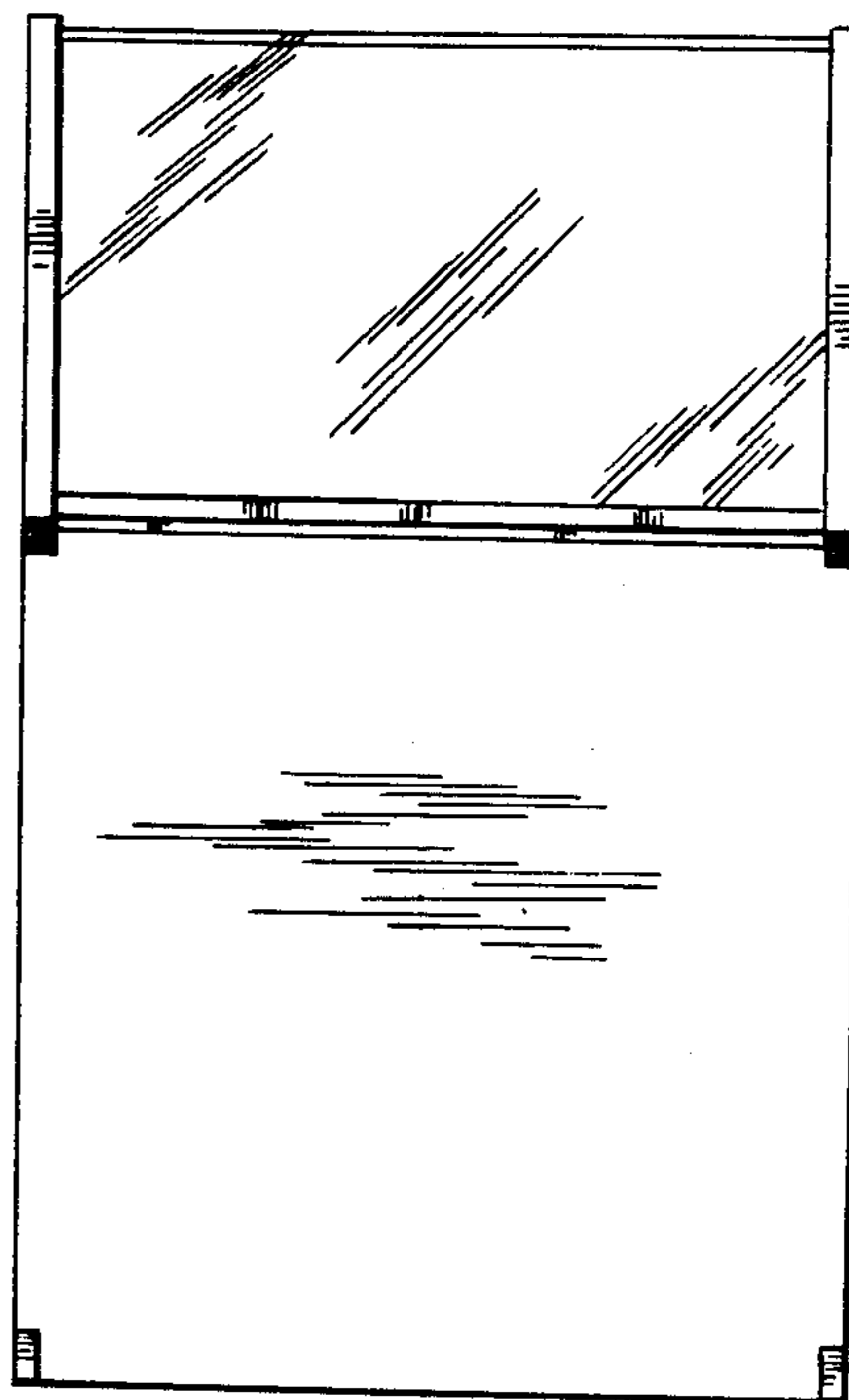

FIG. 6

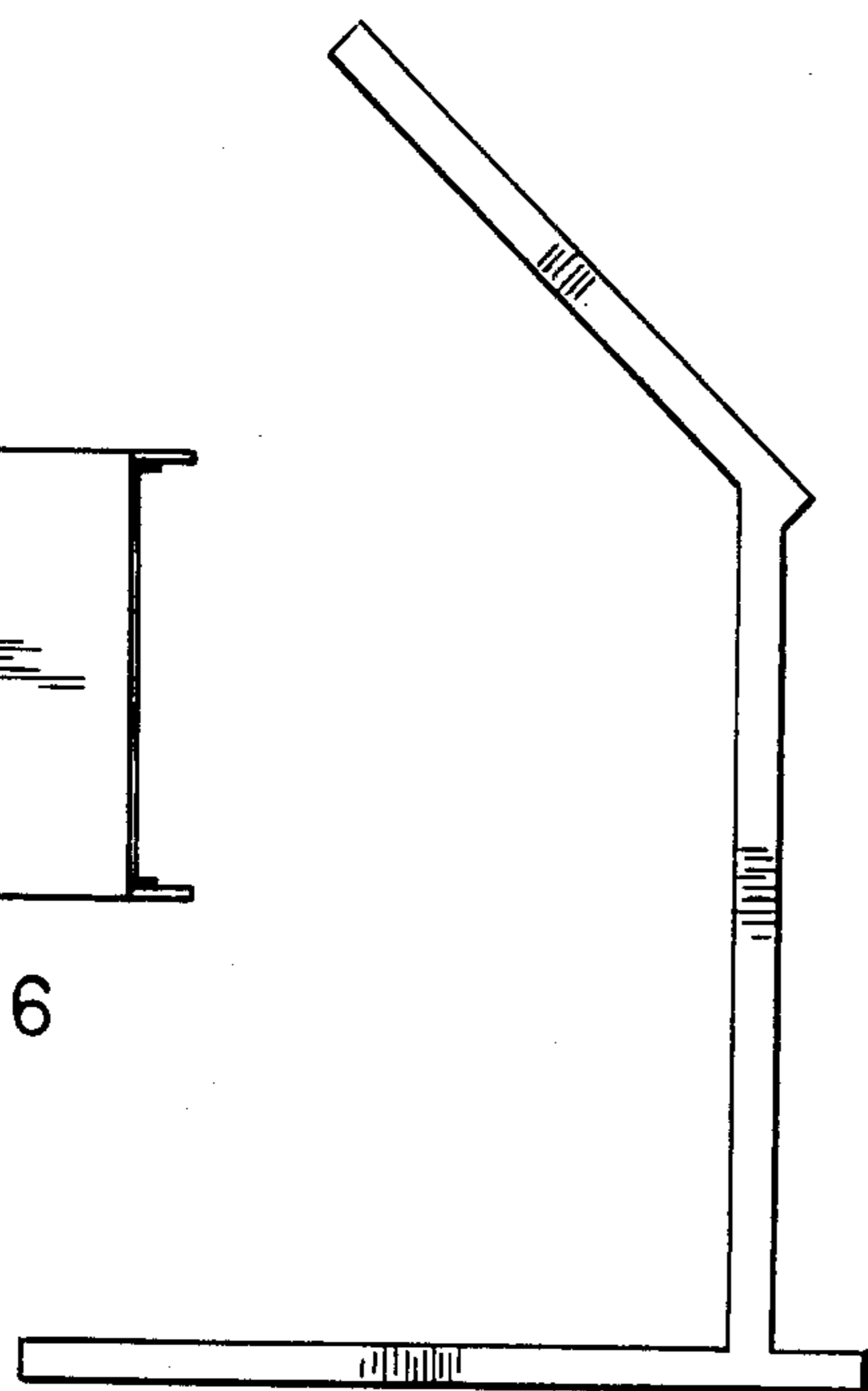

FIG. 2

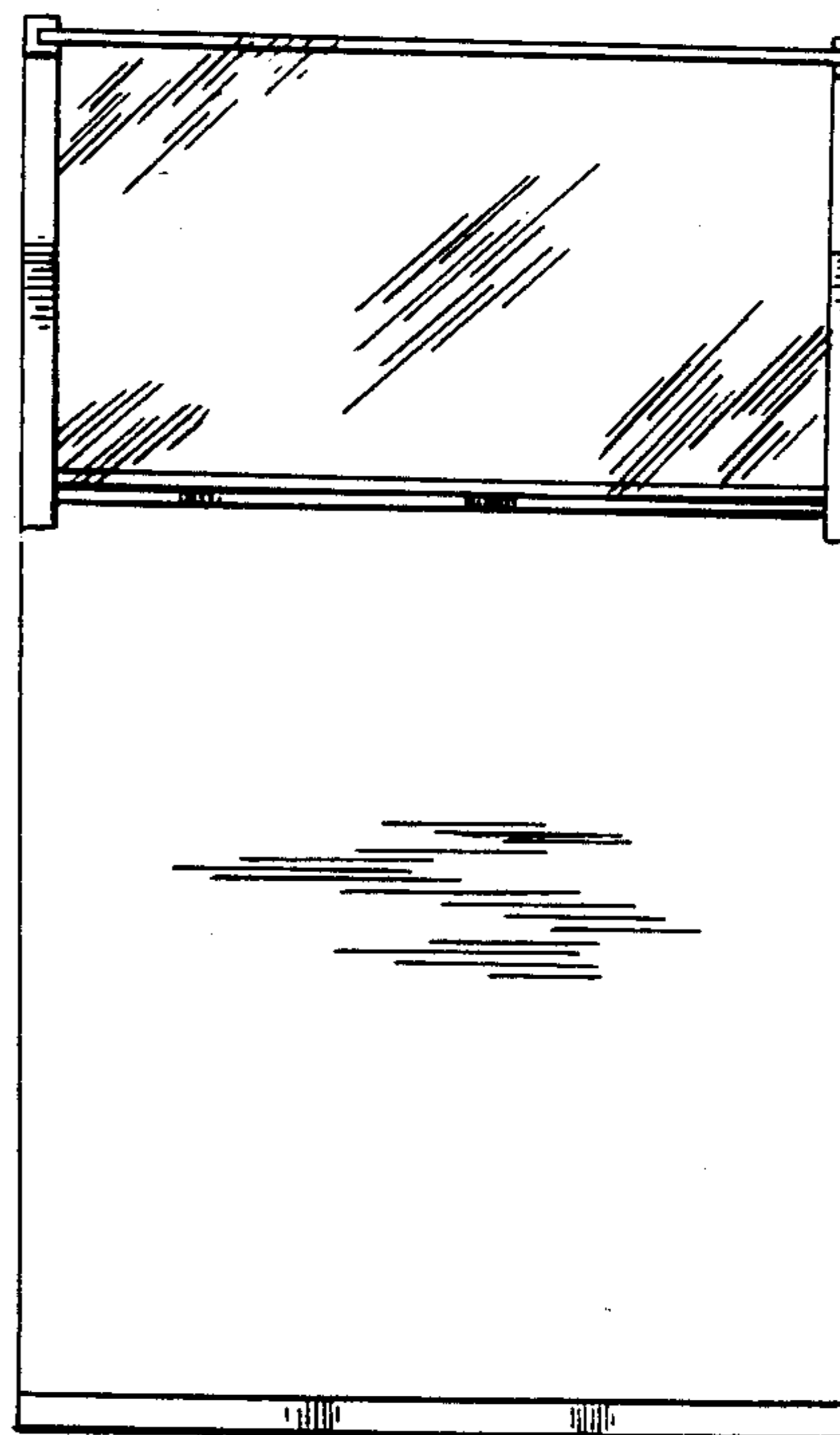

FIG. 5

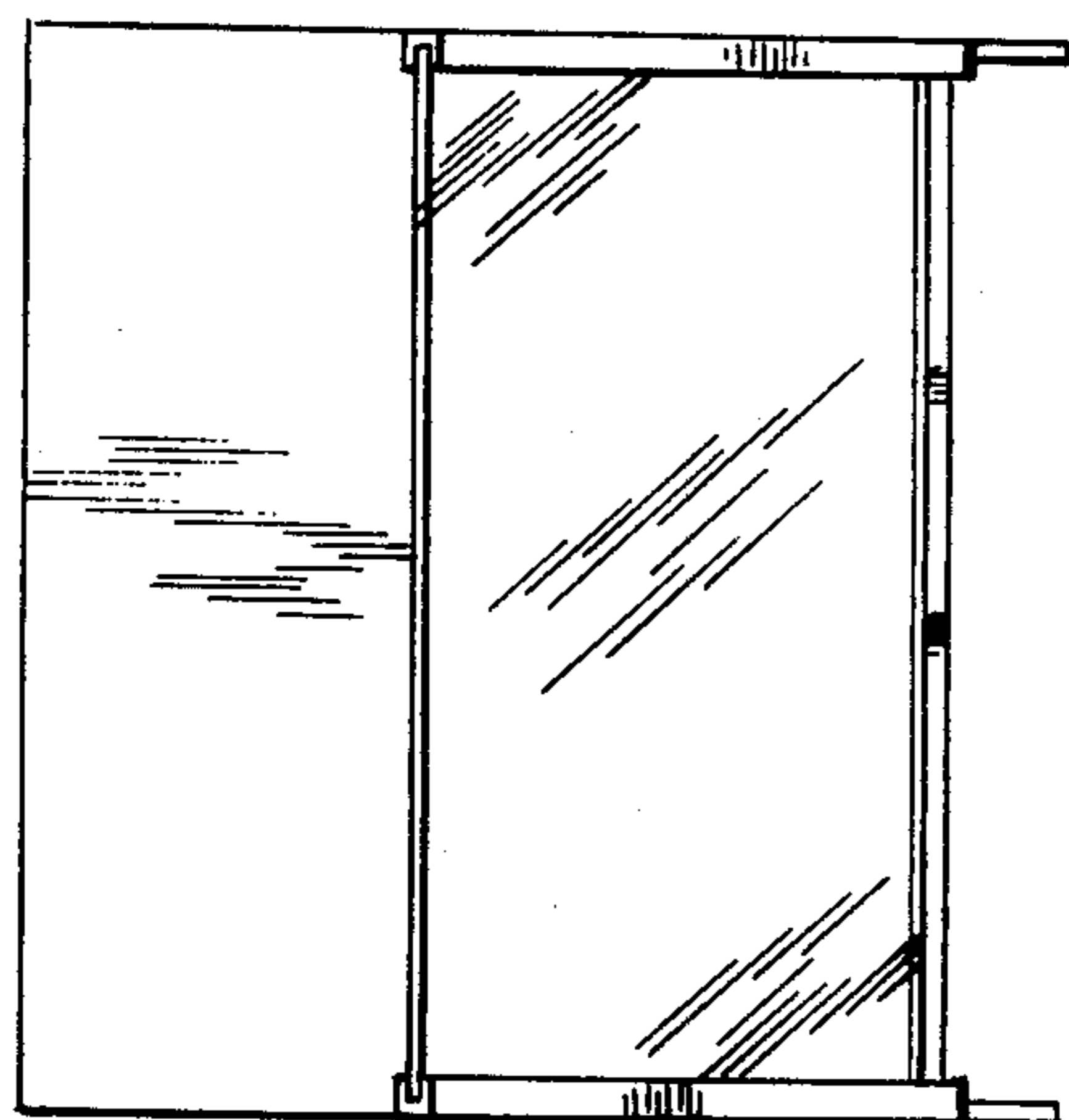

FIG. 3