

[54] **POCKET RACING GAME BOX**

[75] **Inventor:** Arisuke Yamagata, Tokyo, Japan

[73] **Assignee:** Tomy Kogyo Co., Inc., Tokyo, Japan

[\*\*] **Term:** 14 Years

[21] **Appl. No.:** 604,096

[22] **Filed:** Aug. 13, 1975

[51] **Int. Cl.** ..... D21-01

[52] **U.S. Cl.** ..... D34/5 CC

[58] **Field of Search** ..... D34/5 CC, 5 JJ;  
273/86 B, 86 H

[56] **References Cited**

**U.S. PATENT DOCUMENTS**

2,057,888 10/1936 Erickson ..... 273/86 H  
3,326,555 6/1967 Warren ..... 273/86 H

*Primary Examiner*—Melvin B. Feifer  
*Attorney, Agent, or Firm*—James D. Halsey, Jr.

[57] **CLAIM**

The ornamental design for a pocket racing game box, as shown and described.

**DESCRIPTION**

FIG. 1 is a top plan view of a pocket racing game box showing my new design.

FIG. 2 is a front elevational view thereof;

FIG. 3 is a rear elevational view thereof;

FIG. 4 is a right side elevational view thereof; and

FIG. 5 is a left side elevational view thereof.

FIG. 6 is a perspective view thereof.

It is noted that the bottom is flat.

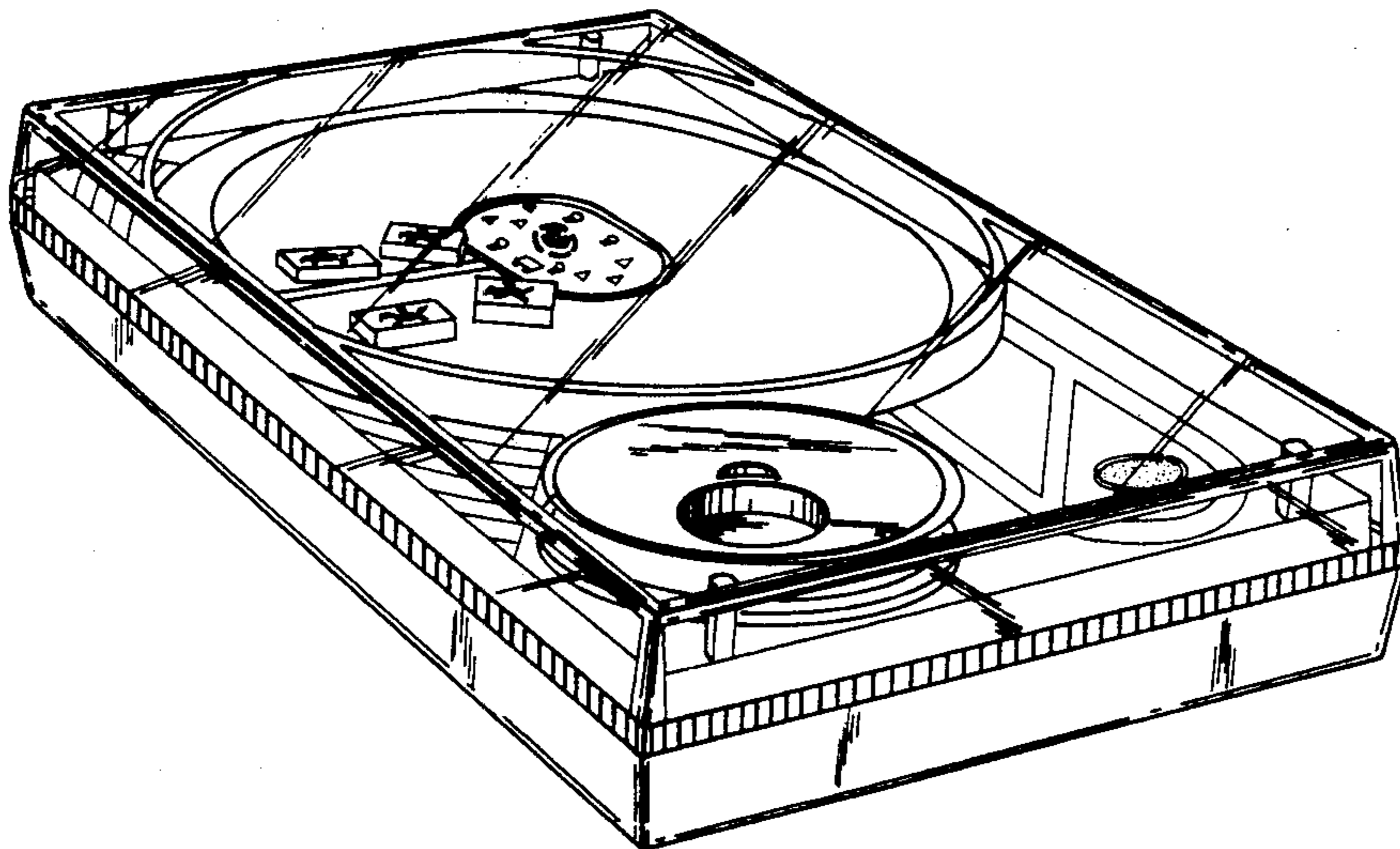

*FIG. 1*

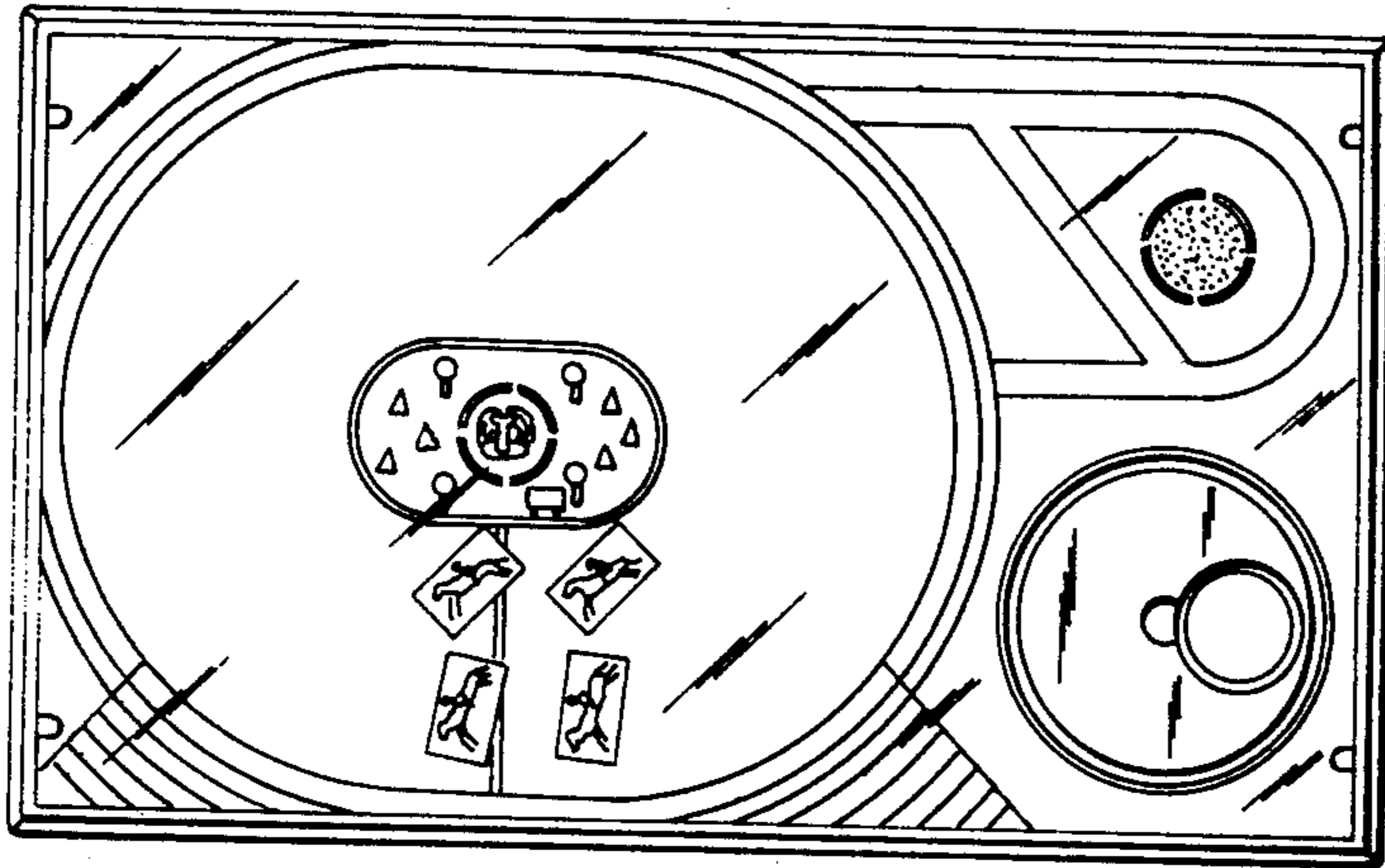

*FIG. 2*

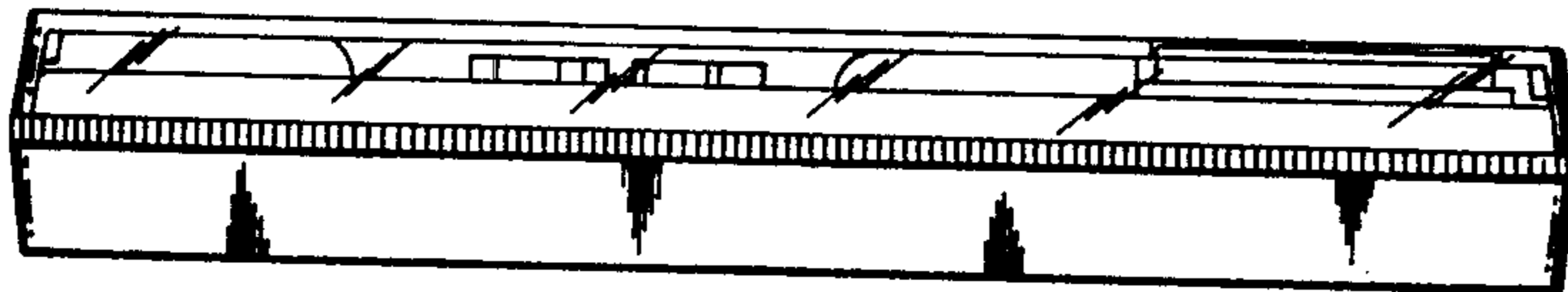

*FIG. 3*

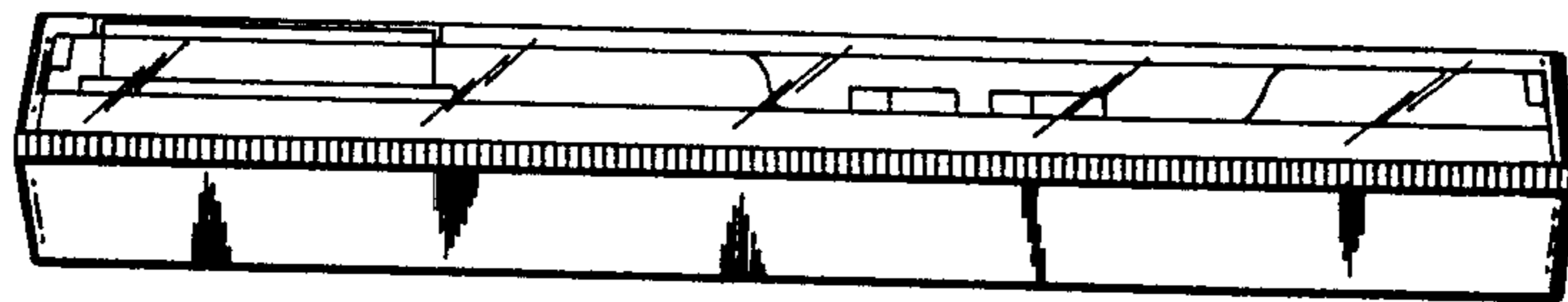

*FIG. 4*

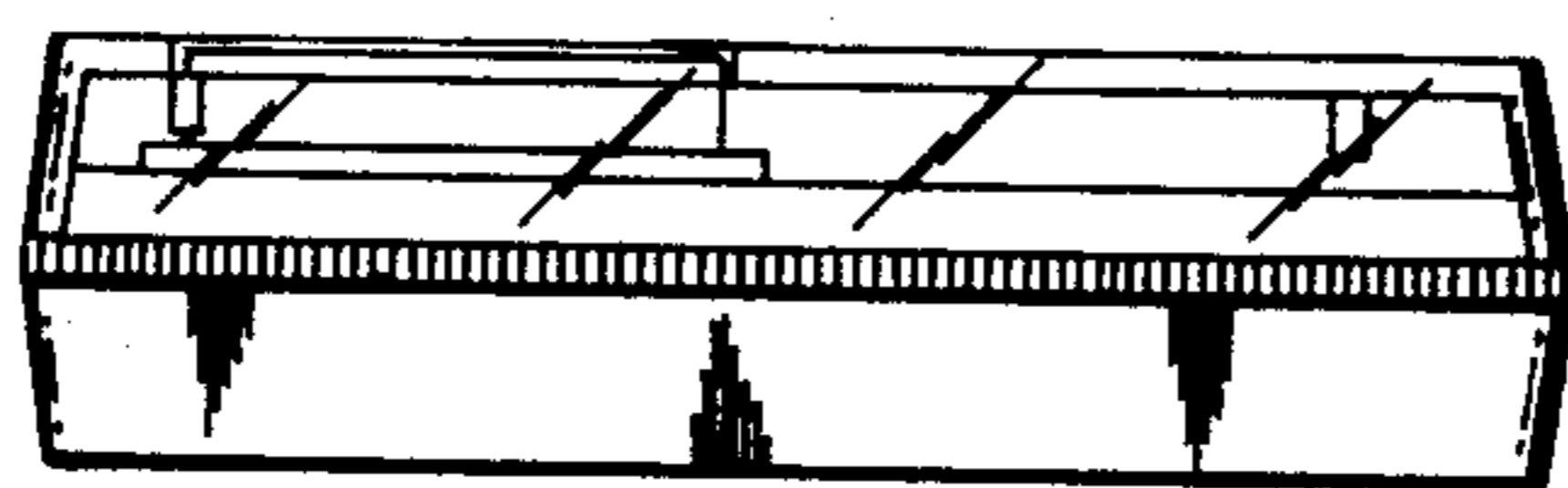

*FIG. 5*

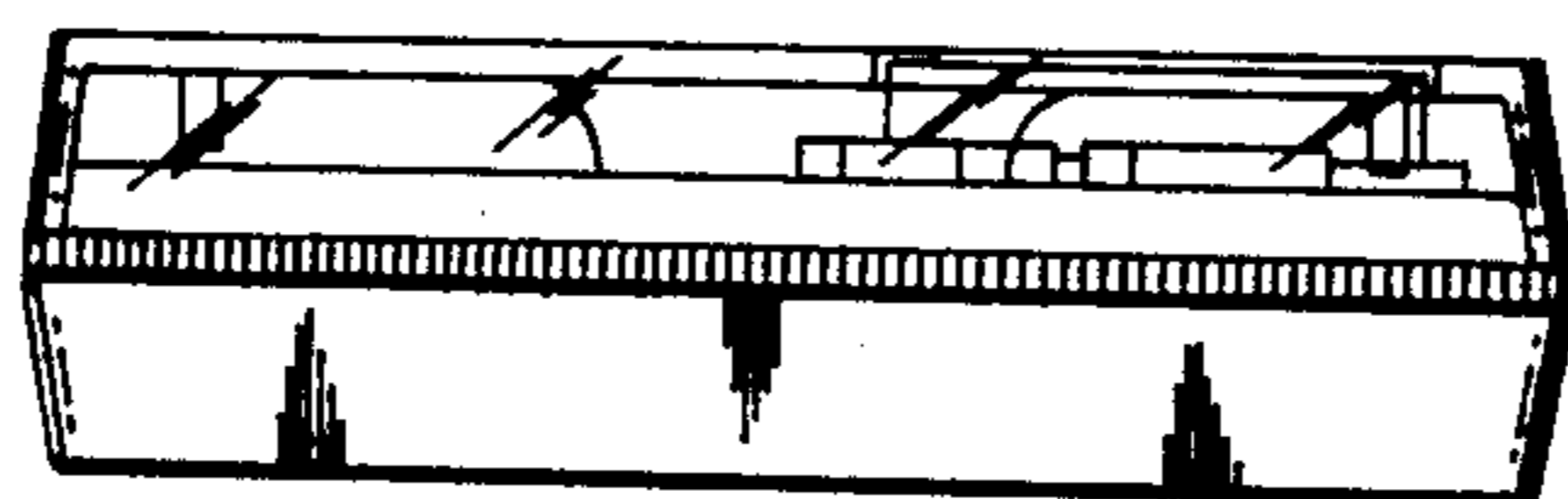

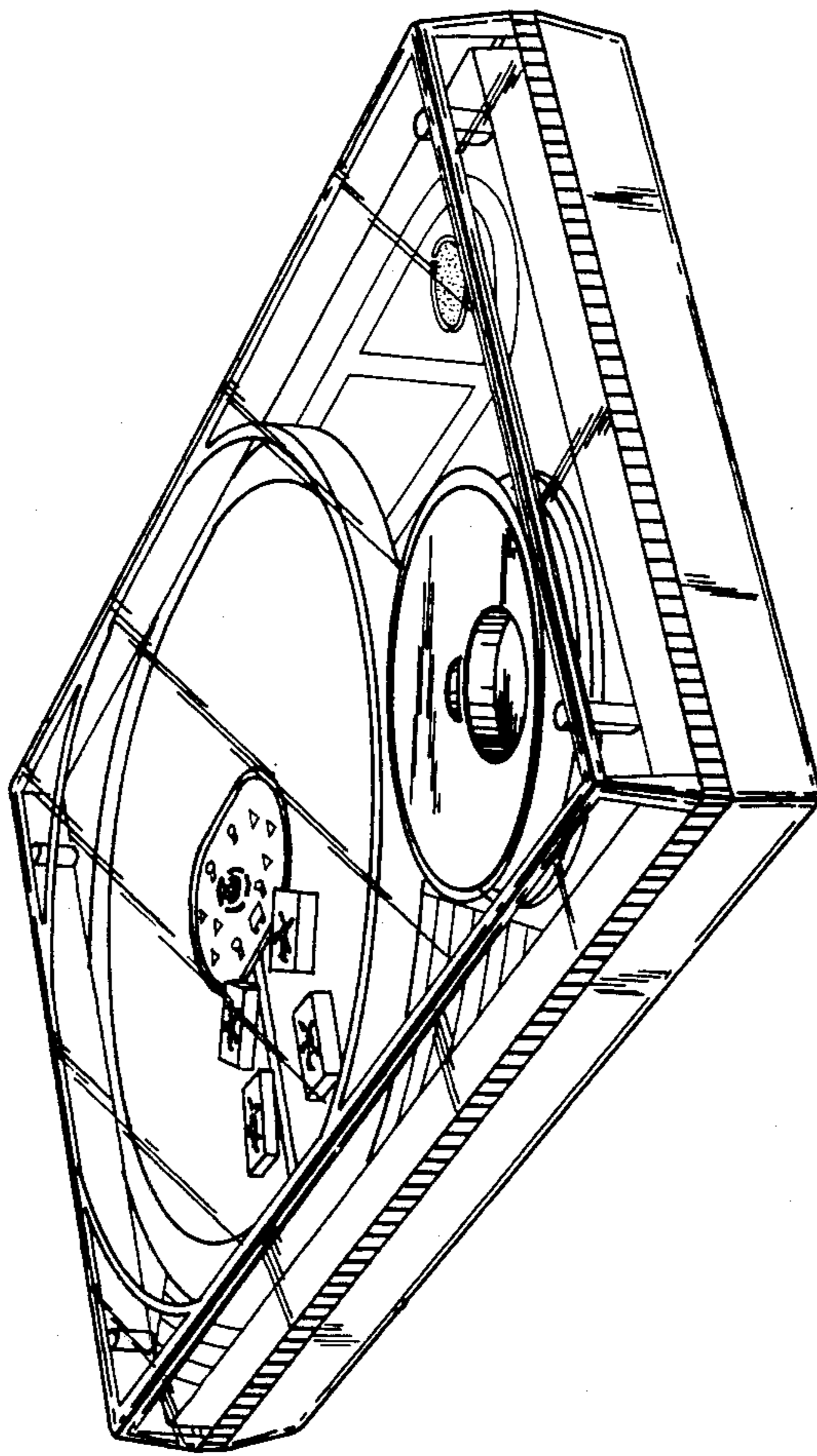

FIG. 6