

[54] TANK TRAILER

[76] Inventors: Donald R. Kerr; Marvin D. Kerr, both of 220 S. Burlington St., Hastings, Nebr. 68901

[\*\*] Term: 14 Years

[21] Appl. No.: 714,753

[22] Filed: Aug. 16, 1976

Related U.S. Application Data

[62] Division of Ser. No. 650,171, Jan. 19, 1976.

[51] Int. Cl. .... D12-10

[52] U.S. Cl. .... D12/95

[58] Field of Search ..... D12/27, 95; D15/27; D23/2; 280/5 C, 5 E

[56] References Cited

U.S. PATENT DOCUMENTS

- 2,671,573 3/1954 Hendon et al. .... 220/5
- 2,967,057 1/1961 Meyer ..... 280/5 E
- D. 85,187 9/1931 Kramer ..... D12/95

D. 204,751 5/1966 Mandez ..... D12/95

OTHER PUBLICATIONS

Butter Truck Tanks, 1931 brochure, front cover, lower left item.

Primary Examiner—James R. Largen

Attorney, Agent, or Firm—George R. Nimmer

[57] CLAIM

The ornamental design for a tank trailer, as shown and described.

DESCRIPTION

FIG. 1 is a front perspective view of a tank trailer showing our new design;

FIG. 2 is a rear elevational view thereof;

FIG. 3 is an elevational view taken from one side thereof, the opposite side being a mirror image of the side shown;

FIG. 4 is a top plan view thereof;

FIG. 5 is a cross sectional view taken along line 5-5 of FIG. 3; and

FIG. 6 is a cross sectional view taken along line 6-6 of FIG. 2.

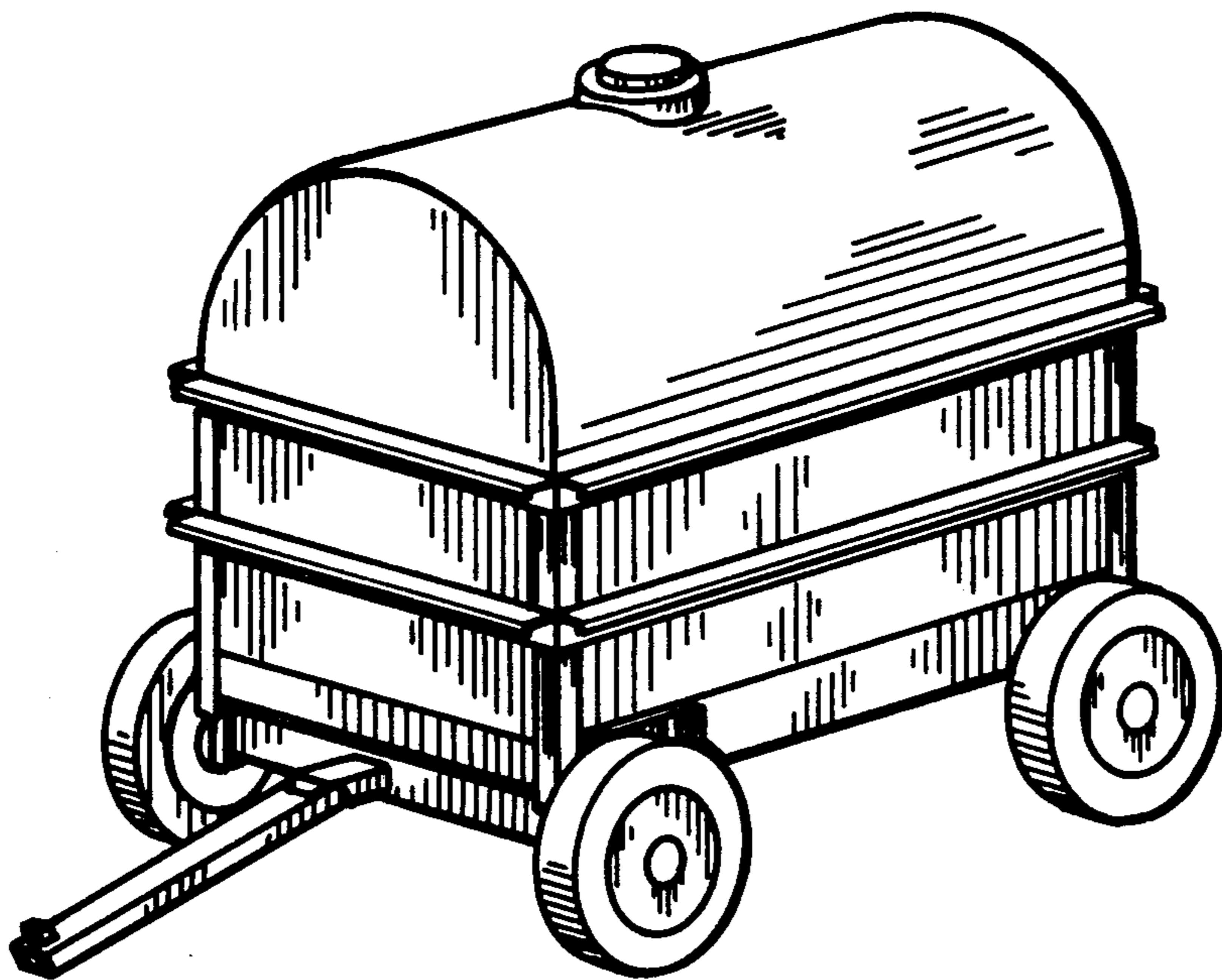

FIG. 1

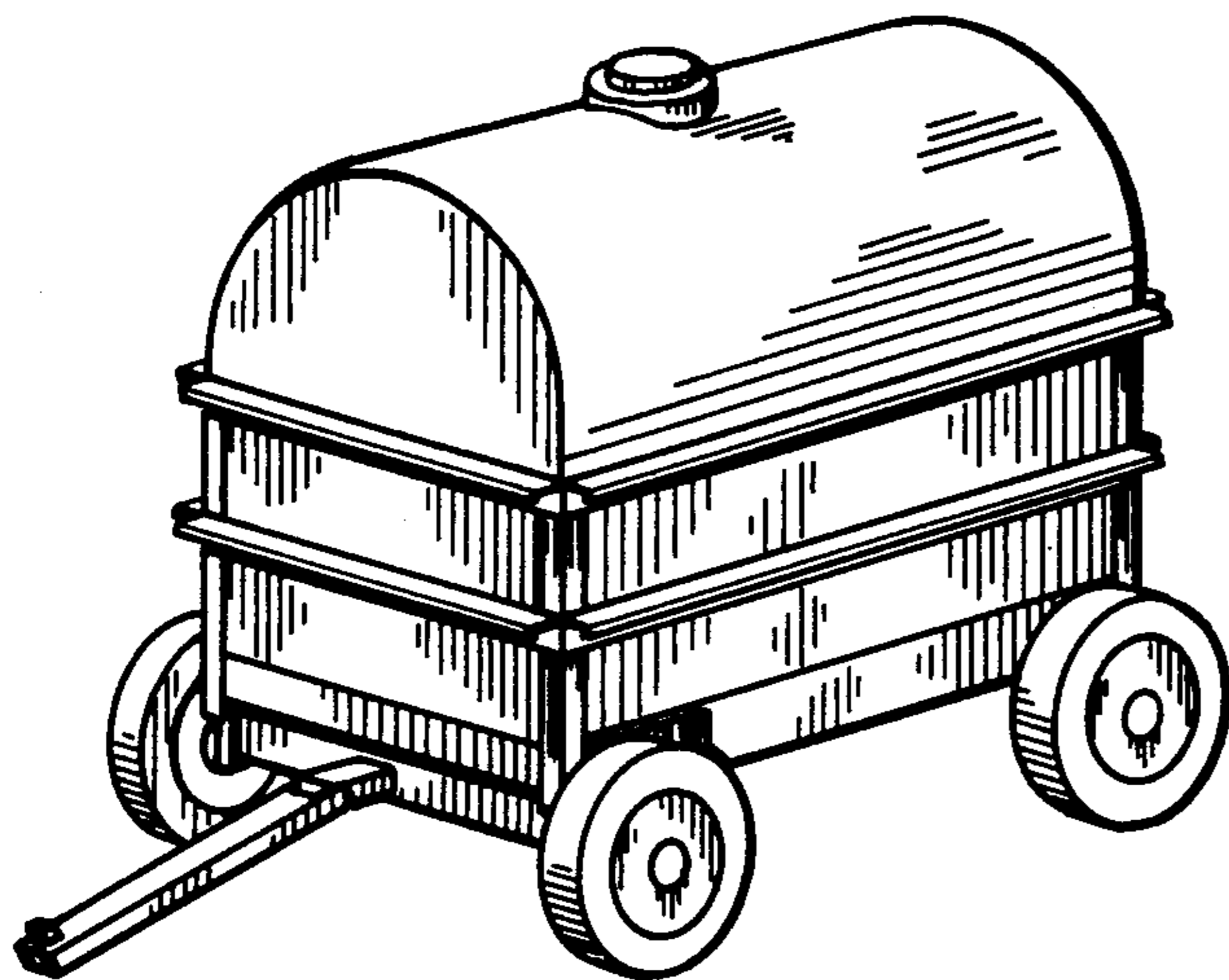

FIG. 2

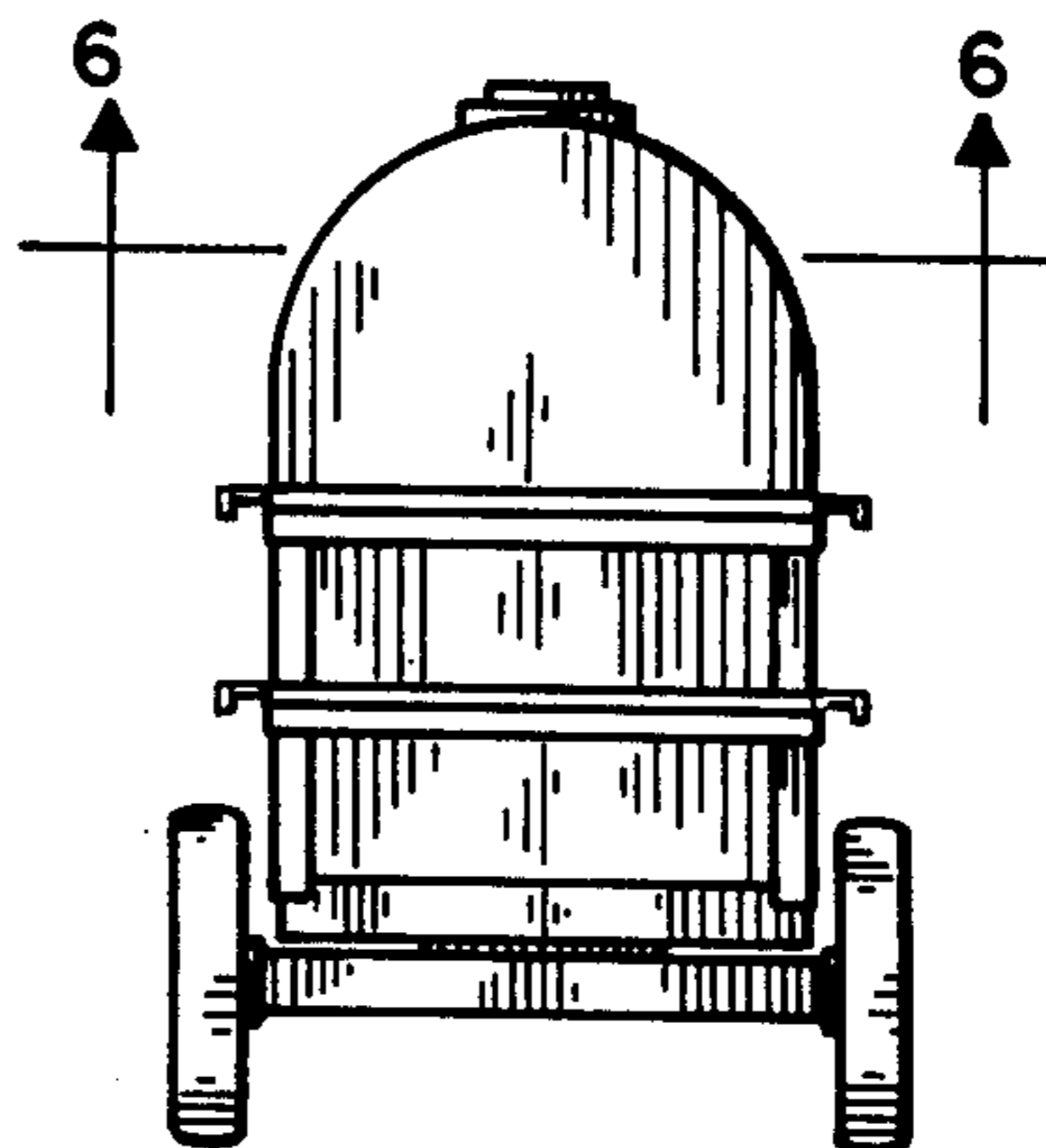

FIG. 3

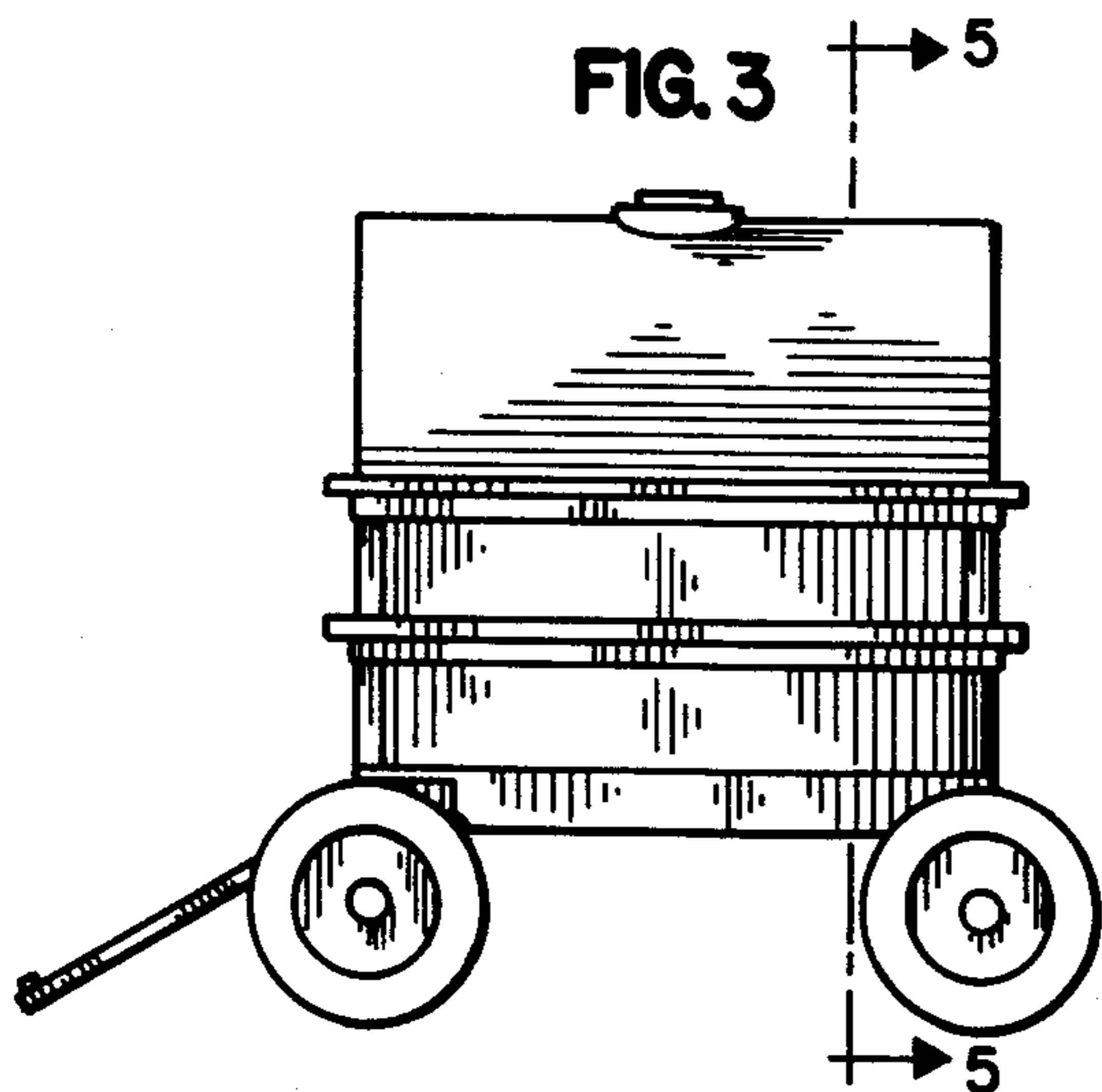

FIG. 4

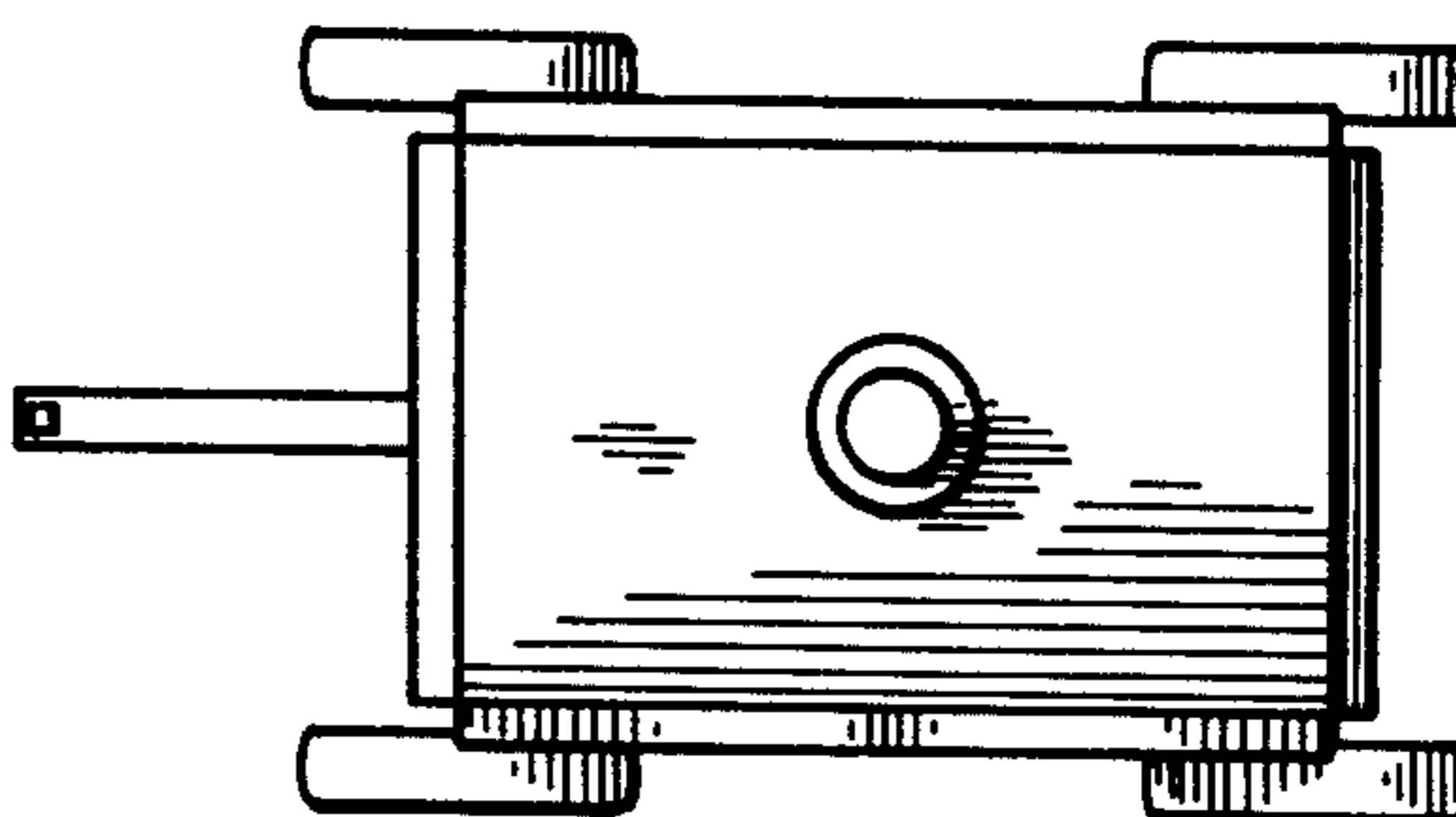

FIG. 5

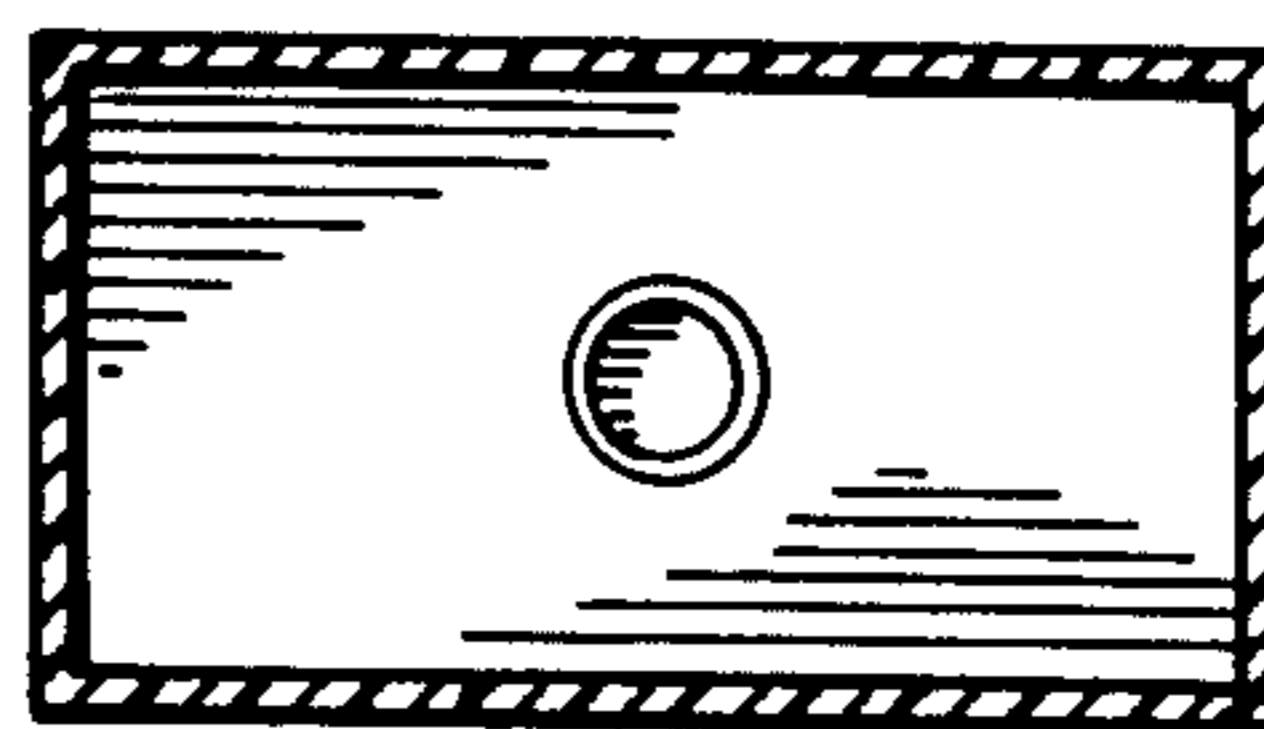
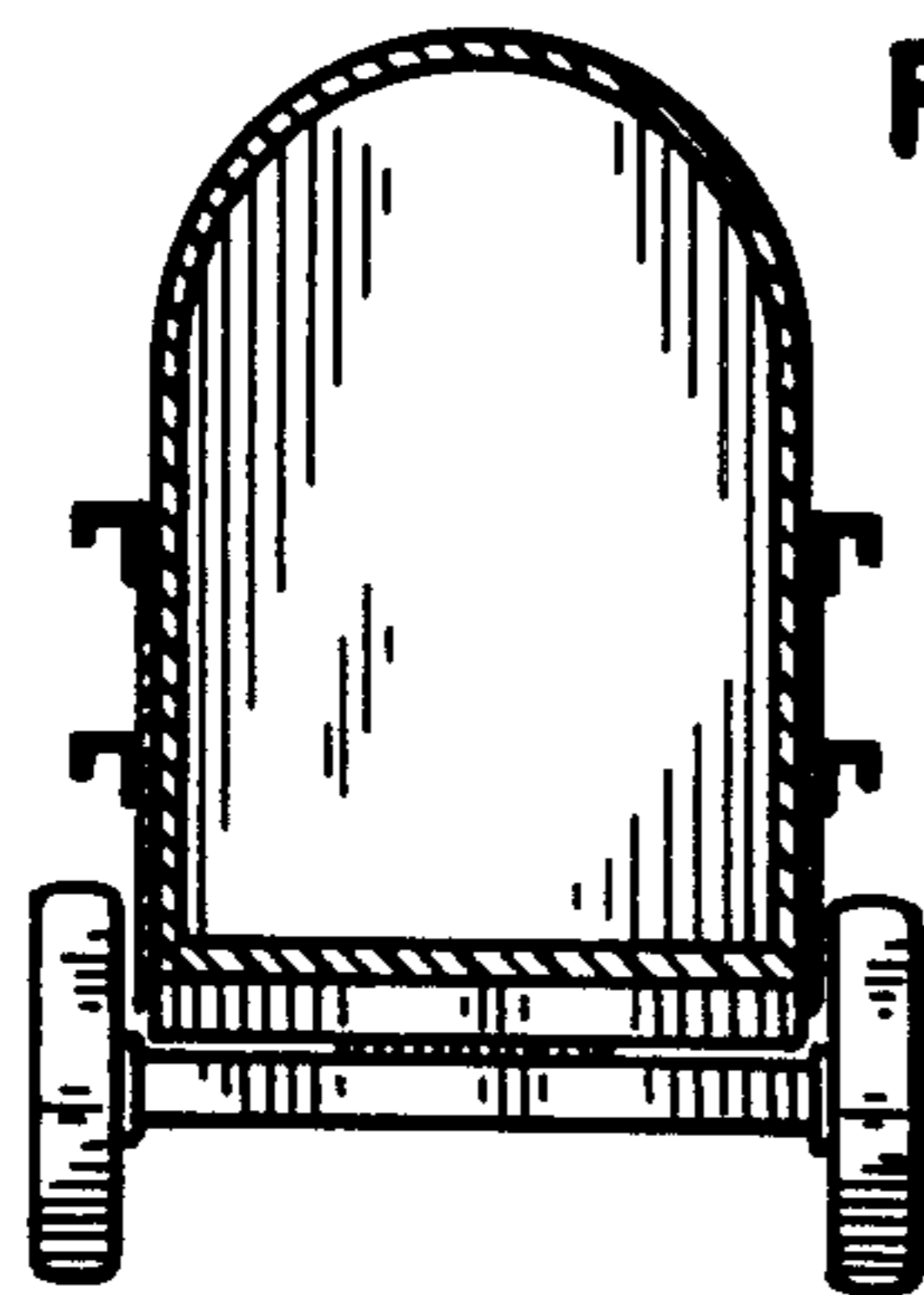

FIG. 6