

[54] EYEGLOSS FRAME

[75] Inventor: Elfriede Teufelhart, Vienna, Austria

[73] Assignee: Optyl Corporation, Norwood, N.J.

[**] Term: 14 Years

[21] Appl. No.: 624,331

[22] Filed: Oct. 21, 1975

[51] Int. Cl. D16-06

[52] U.S. Cl. D16/65

[58] Field of Search 351/41, 44, 49, 50,
351/78, 83, 85, 86, 87, 88, 89, 102, 111, 124

[56] References Cited

U.S. PATENT DOCUMENTS

D. 148,974 3/1948 Bolle D57/1 F
D. 228,674 10/1973 Shindler D57/1 F

OTHER PUBLICATIONS

Optical Journal & Review of Optometry, Mar. 15, 1974,
p. 22, "Perigee" frame.

Optician, July 6, 1973, p. 27, "Victoria" frame.

Primary Examiner—Wallace R. Burke

Assistant Examiner—Catherine Kemper

Attorney, Agent, or Firm—Morton Amster

[57] CLAIM

An ornamental design for eyeglass frame, substantially
as shown and described.

DESCRIPTION

FIG. 1 is a perspective view of an eyeglass frame show-
ing my new design;

FIG. 2 is a front elevational view thereof;

FIG. 3 is a rear elevational view thereof;

FIG. 4 is a top plan view thereof on a reduced scale;

FIG. 5 is a bottom plan view thereof on a reduced scale;

and,

FIG. 6 is a right side elevational view.

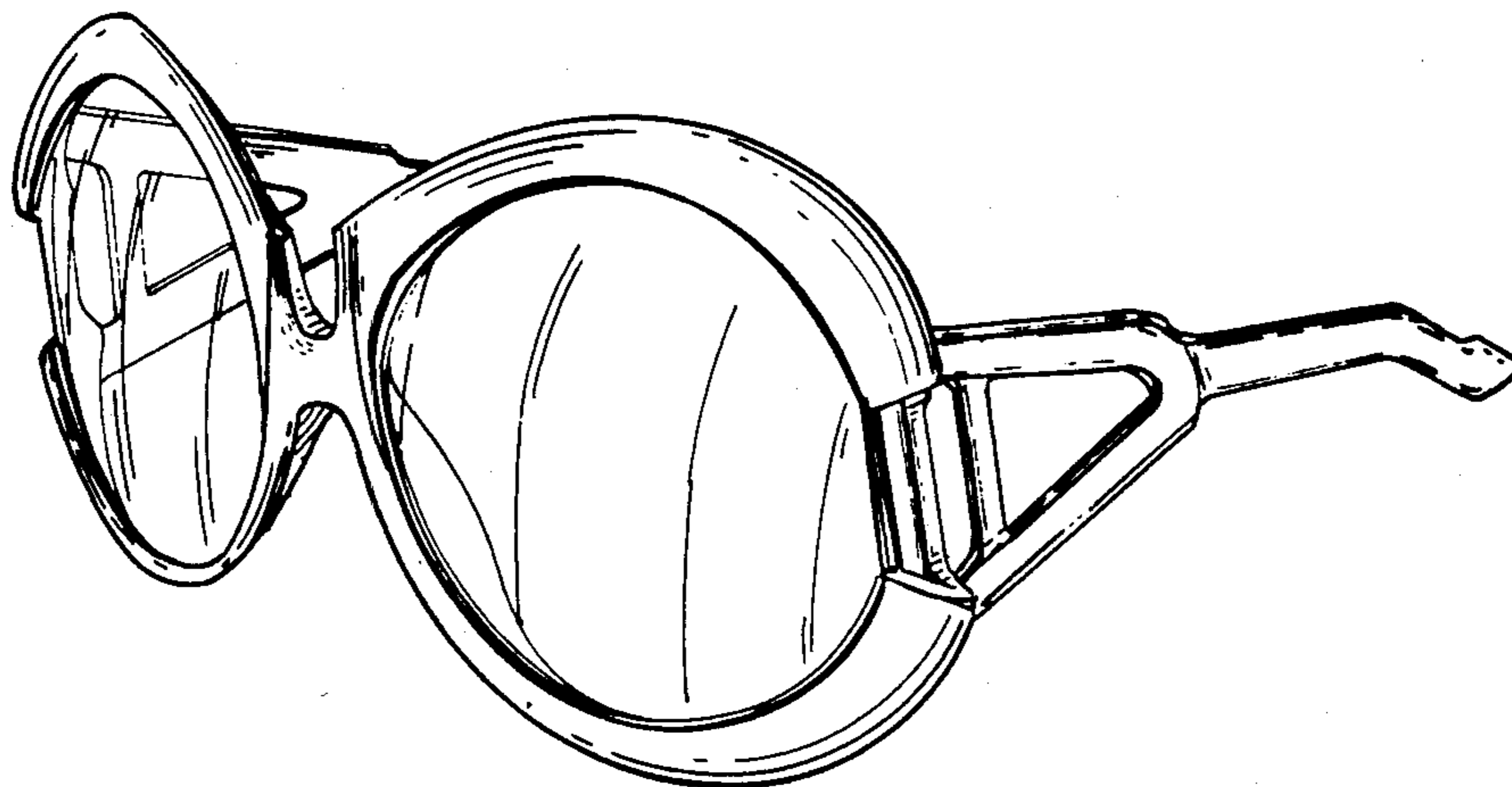

FIG. 1

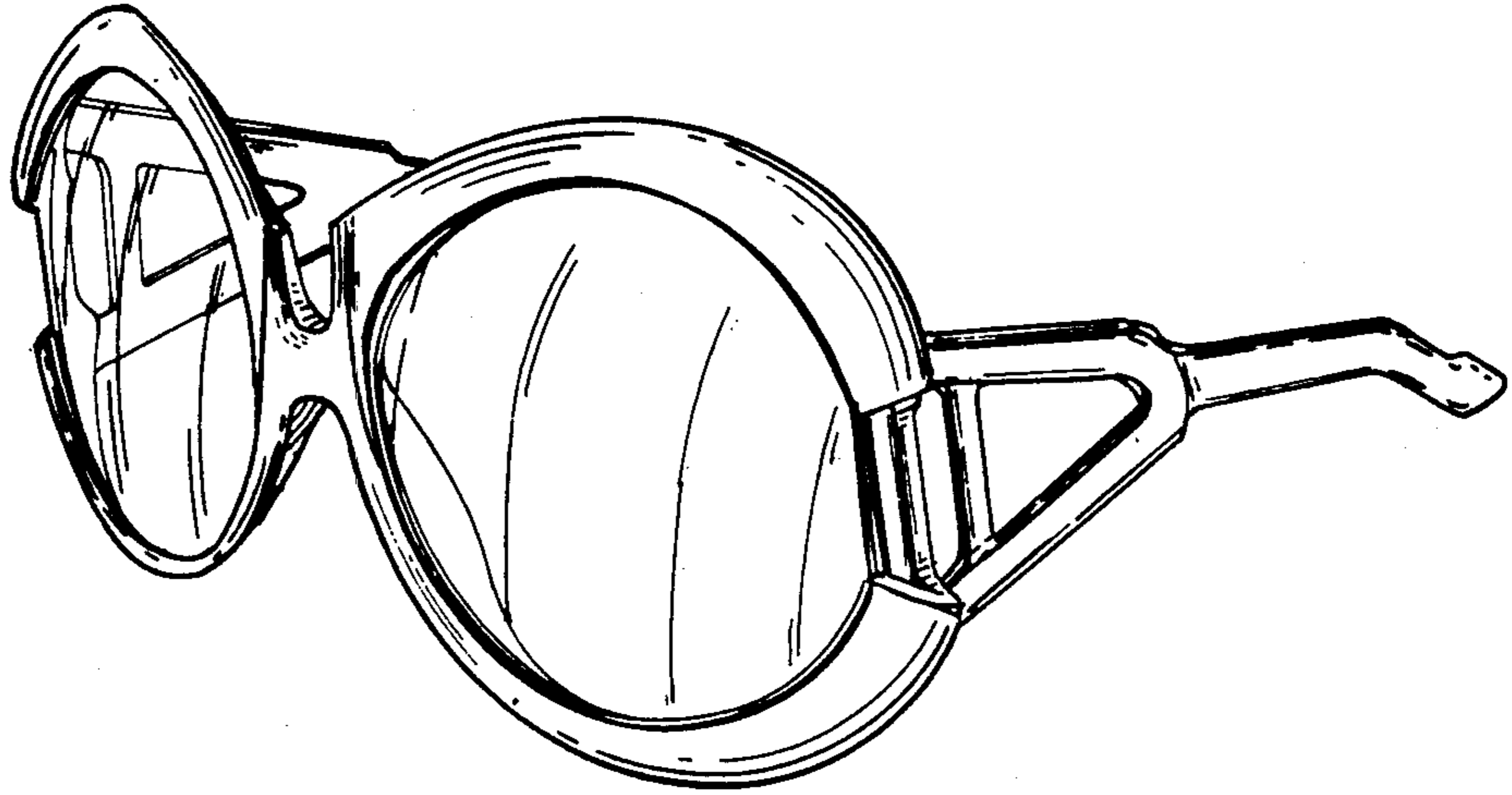

FIG. 2

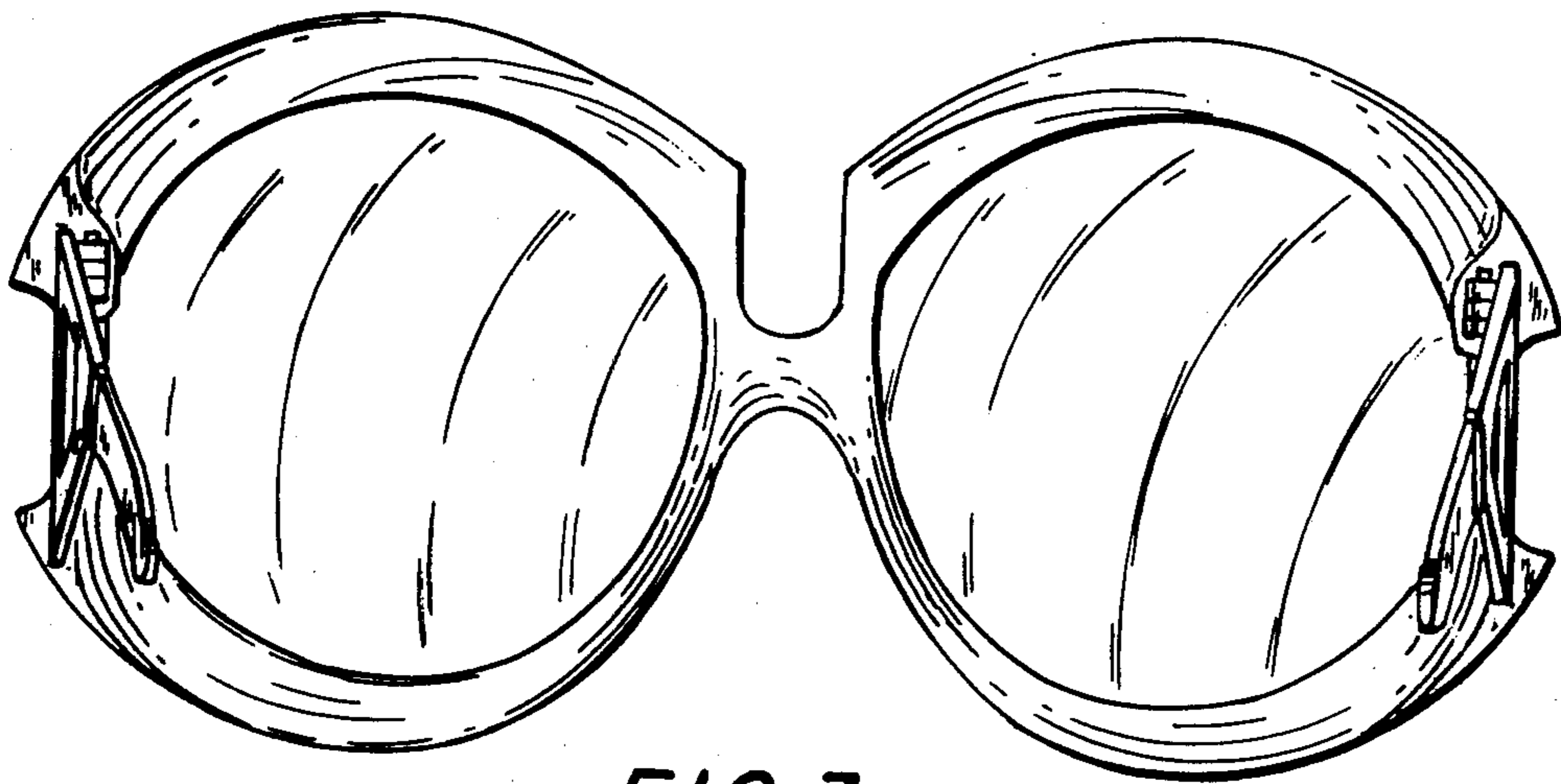
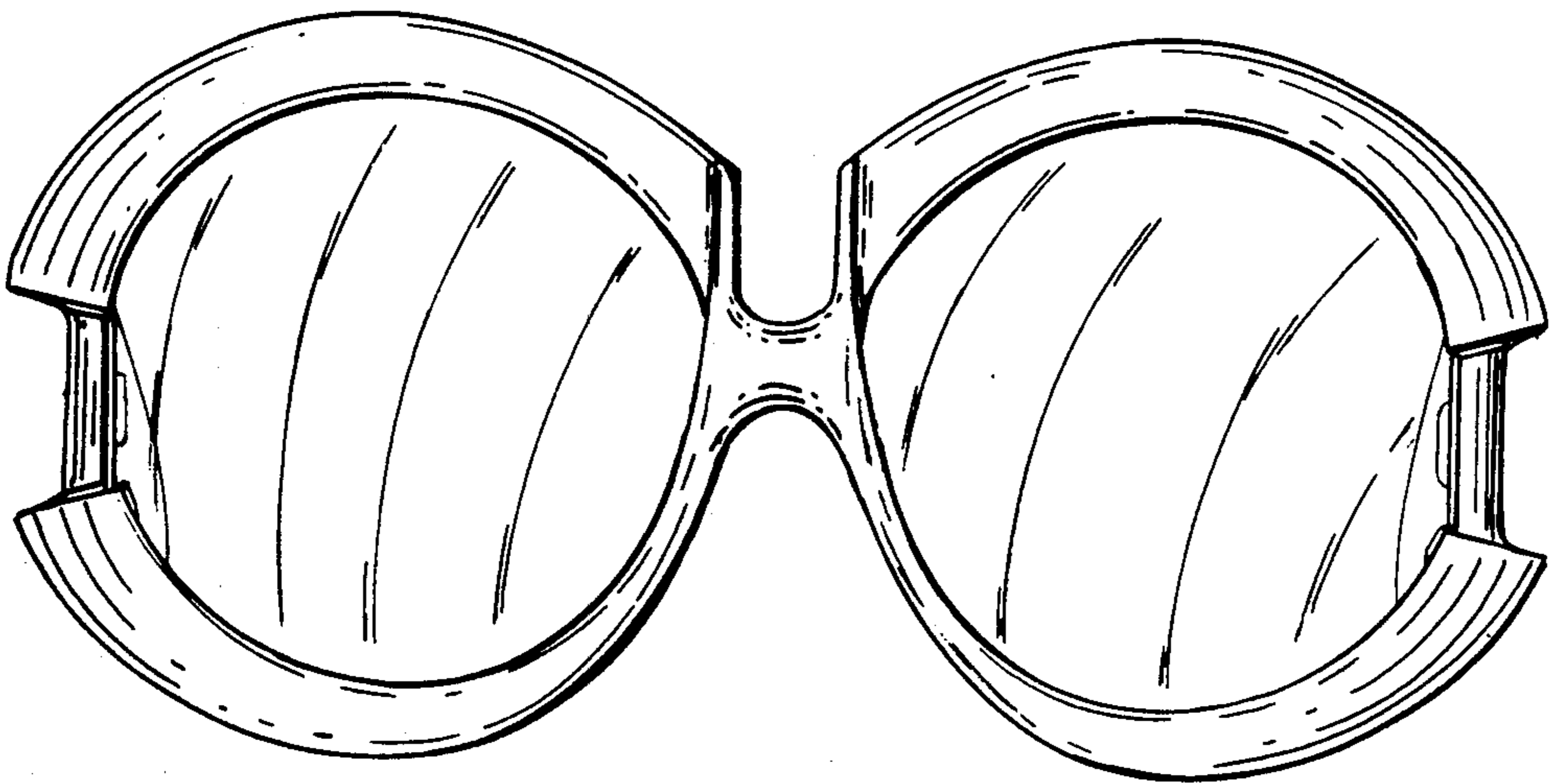

FIG. 3

FIG. 4

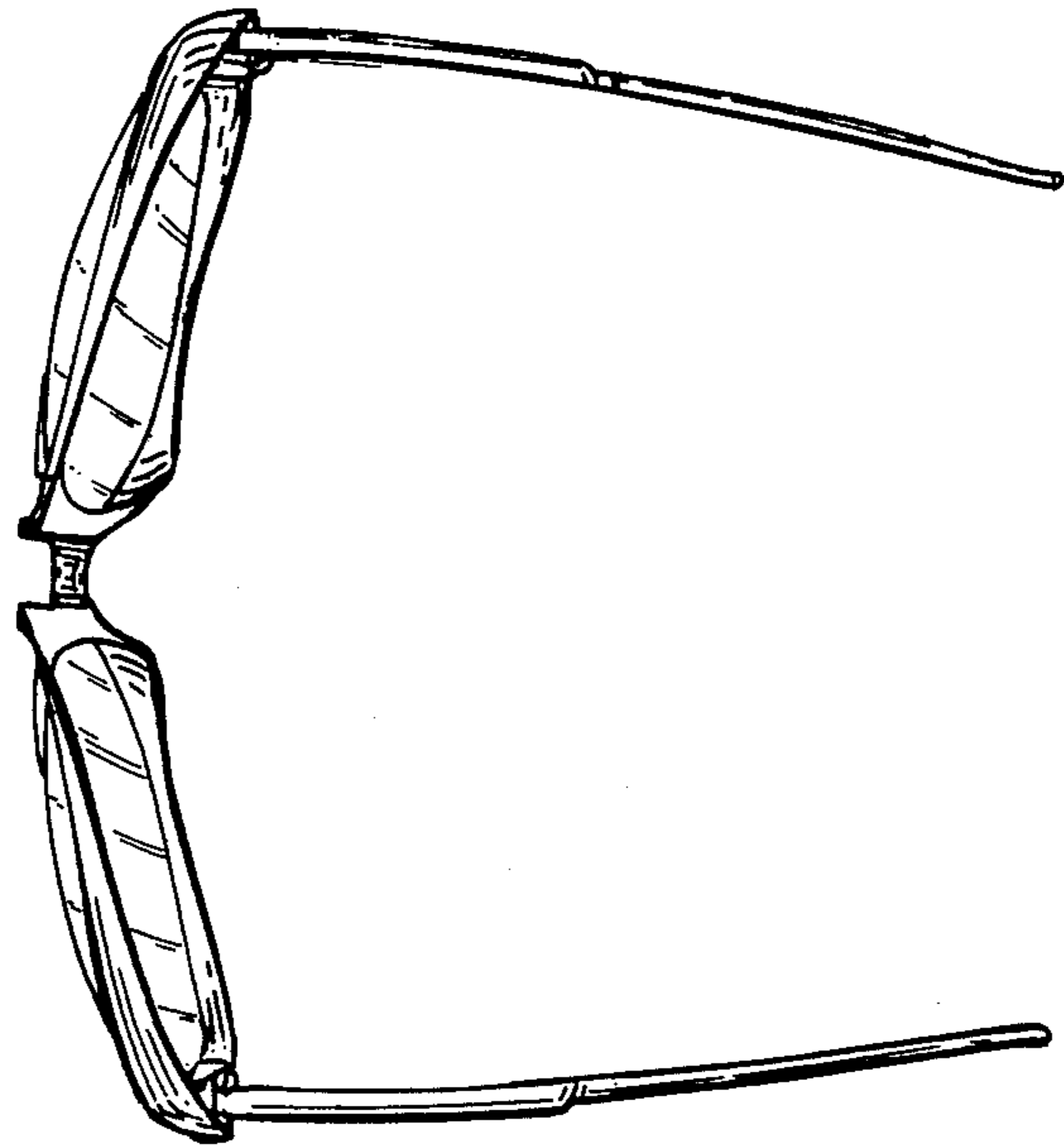

FIG. 5

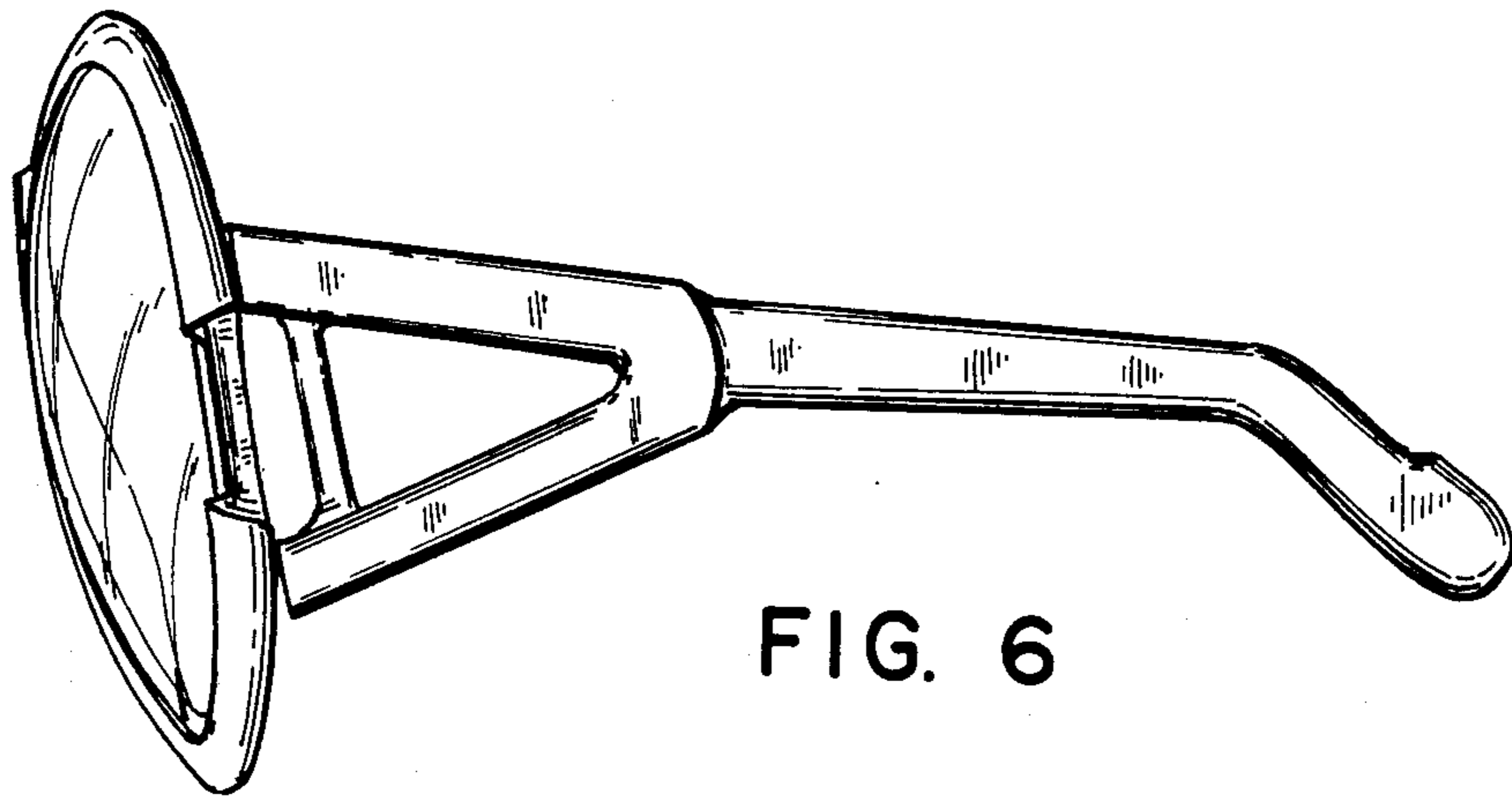
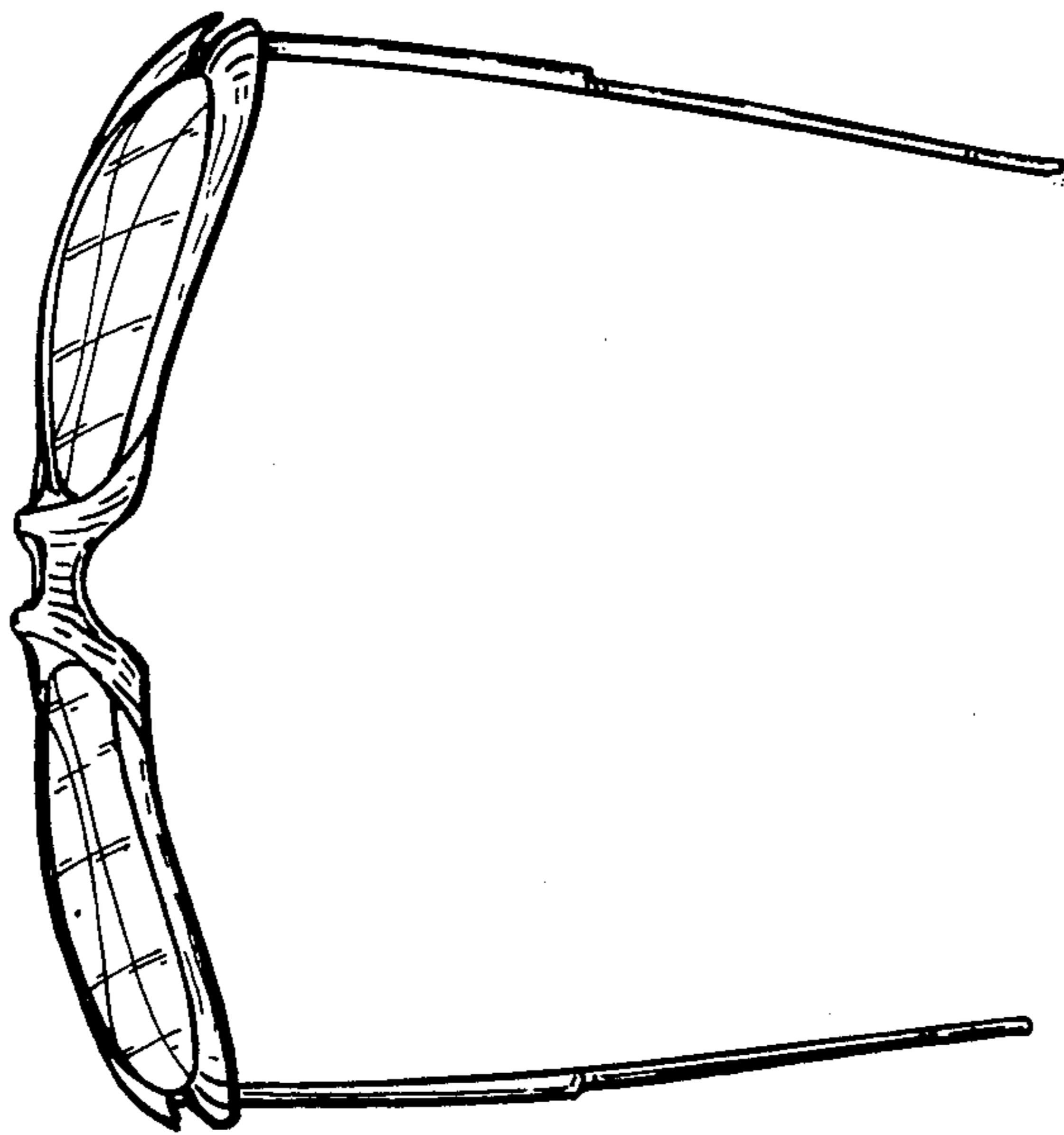

FIG. 6