

[54] RIBBON CARTRIDGE

[75] Inventor: Richard D. Trezise, Newark, Calif.

[73] Assignee: Xerox Corporation, Stamford, Conn.

[**] Term: 14 Years

[21] Appl. No.: 607,656

[22] Filed: Aug. 25, 1975

[51] Int. Cl. D18-01

[52] U.S. Cl. D64/11 A

[58] Field of Search D64/11 A; D26/1 R, 14 B; 197/151, 168; 242/55.19 A, 197-200

[56] References Cited

U.S. PATENT DOCUMENTS

3,734,052	5/1973	Feldman	116/135 X
3,918,569	11/1975	Parker	197/151 X
D. 221,903	9/1971	De Vries	D26/1 R

D. 231,800	6/1974	Hess	D64/11 A
D. 234,633	3/1975	Bellini	D64/11 A
D. 237,010	9/1975	Gnutzman et al.	D64/11 A

Primary Examiner—Joel Stearman
Assistant Examiner—Louis S. Zarfes
Attorney, Agent, or Firm—James J. Ralabate

[57] CLAIM

The ornamental design for a ribbon cartridge, as shown.

DESCRIPTION

FIG. 1 is a perspective view of a ribbon cartridge showing my new design;
FIG. 2 is a top plan view thereof;
FIG. 3 is a right side elevational view thereof;
FIG. 4 is a bottom plan view thereof;
FIG. 5 is a left side elevational view thereof;
FIG. 6 is an elevational view of the ribbon end; and
FIG. 7 is an elevational view of the end opposite that shown in FIG. 6.

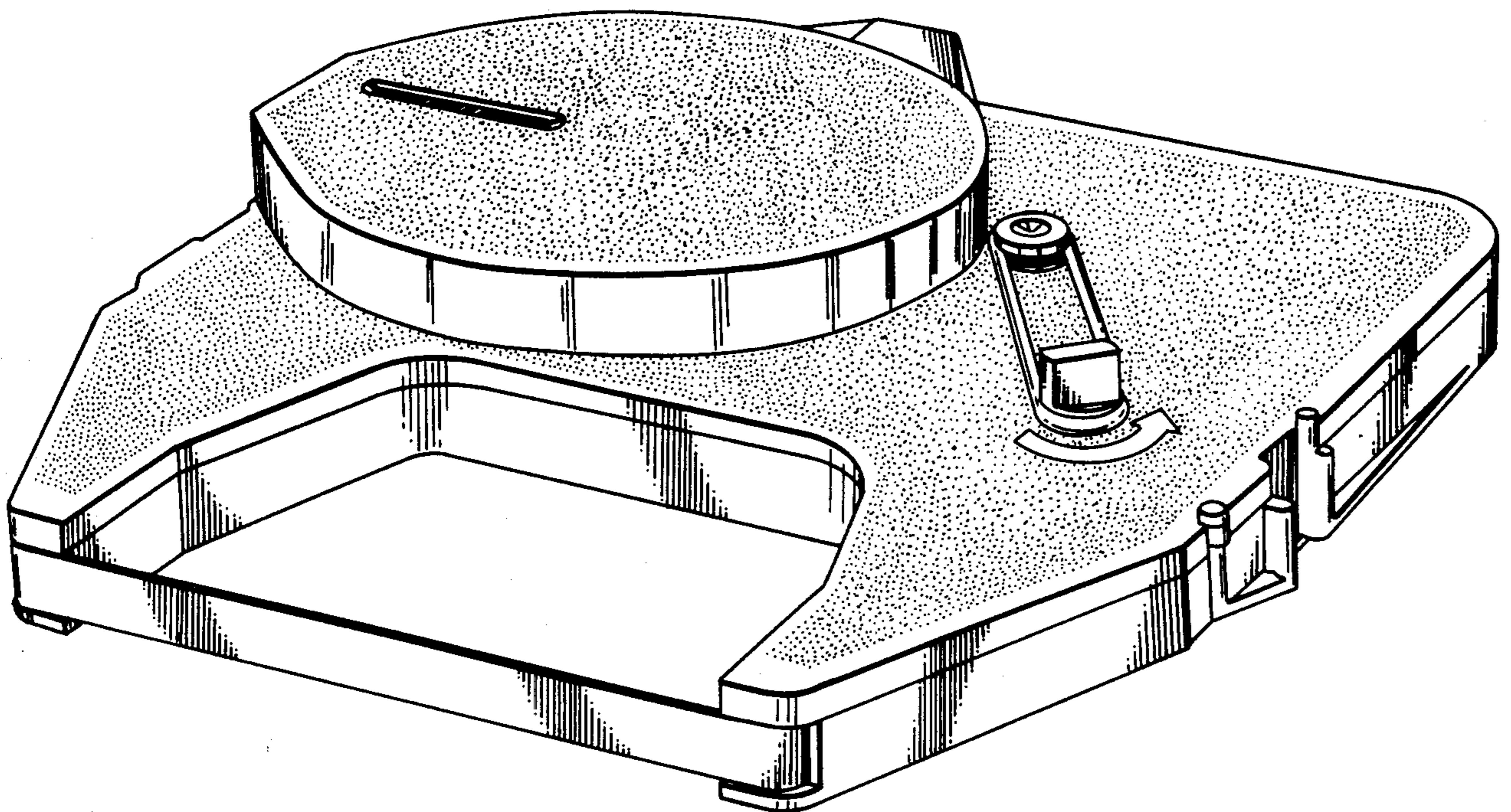

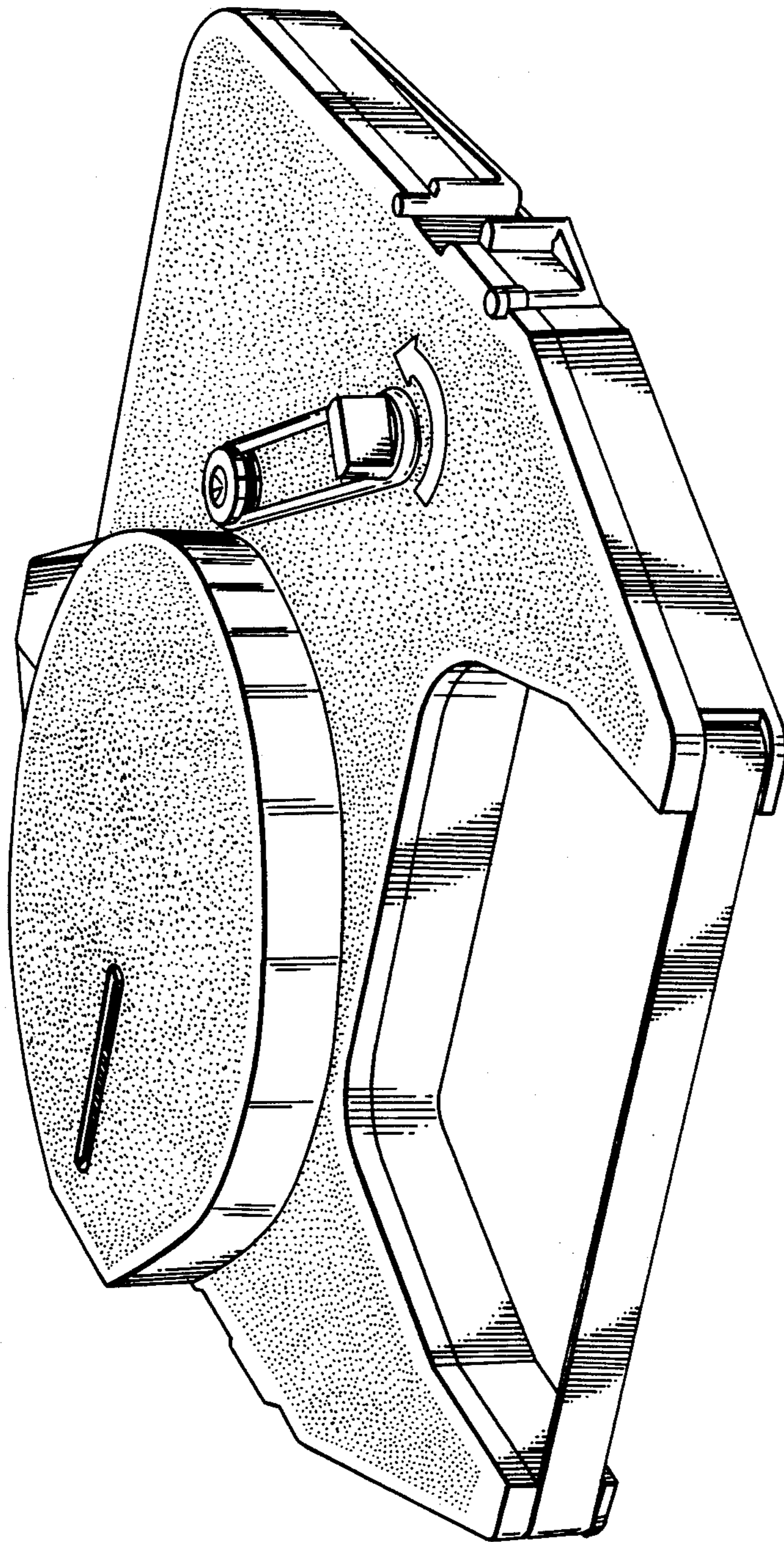

FIG. 1

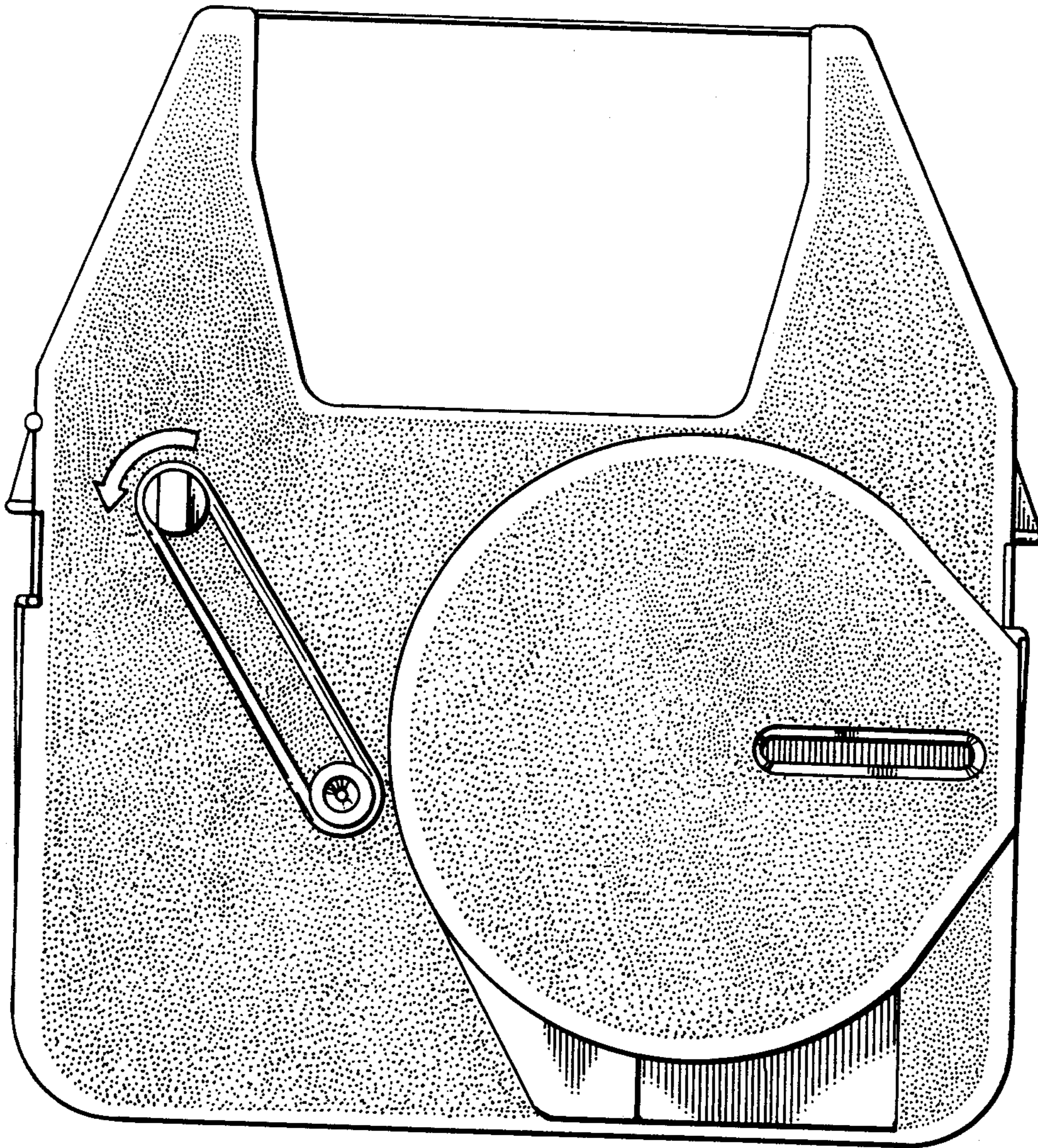

FIG. 2

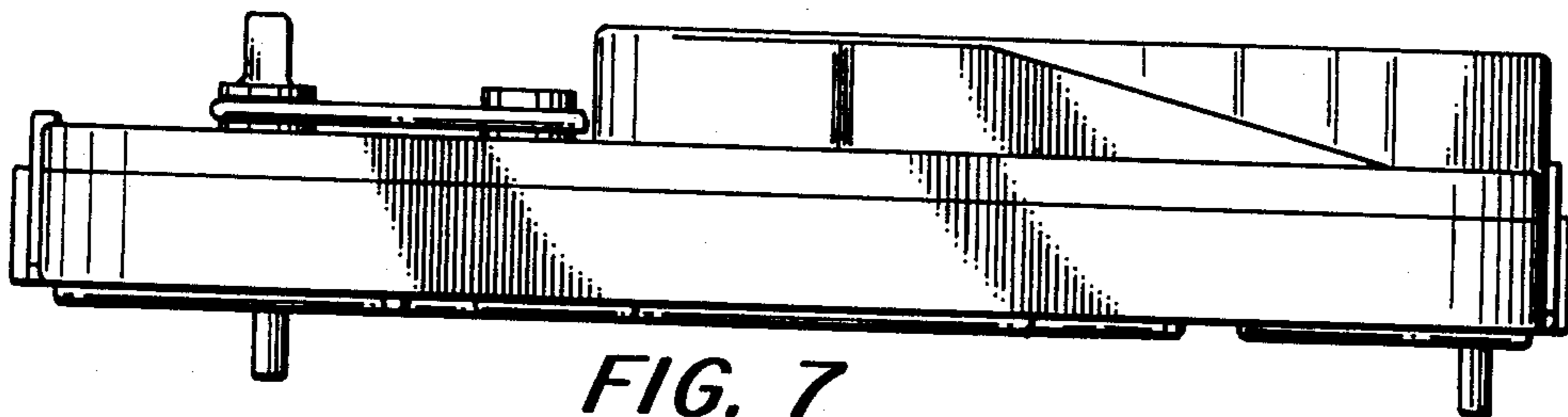

FIG. 7

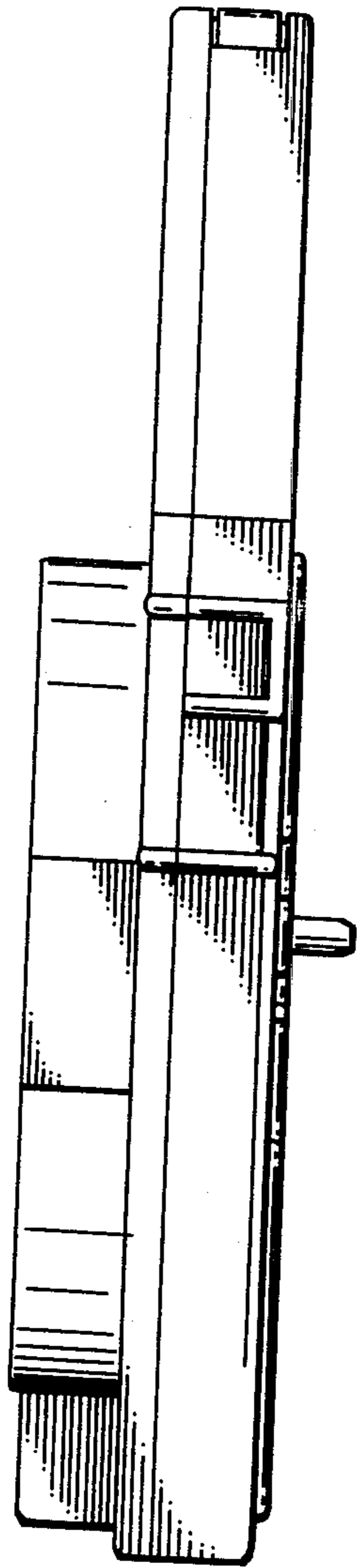

FIG. 3

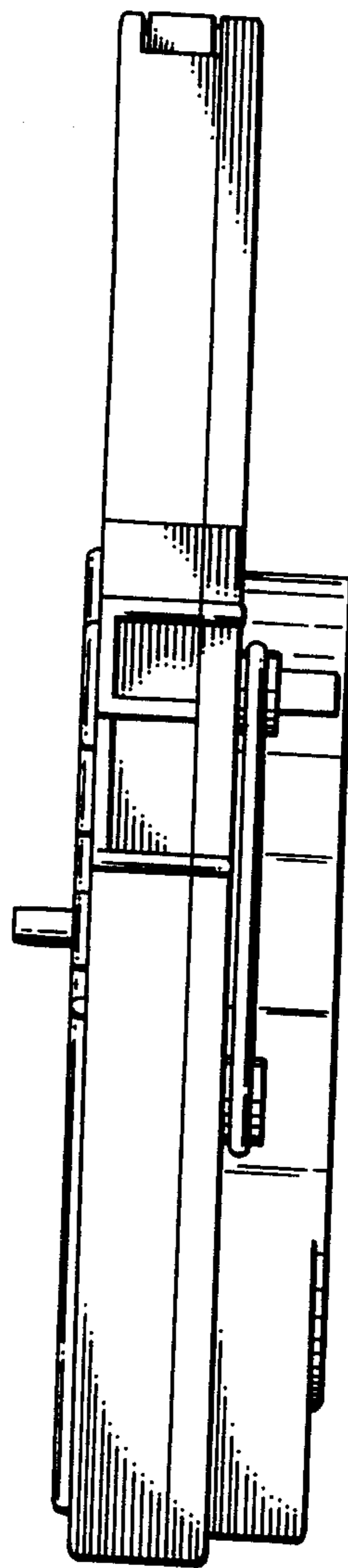

FIG. 5

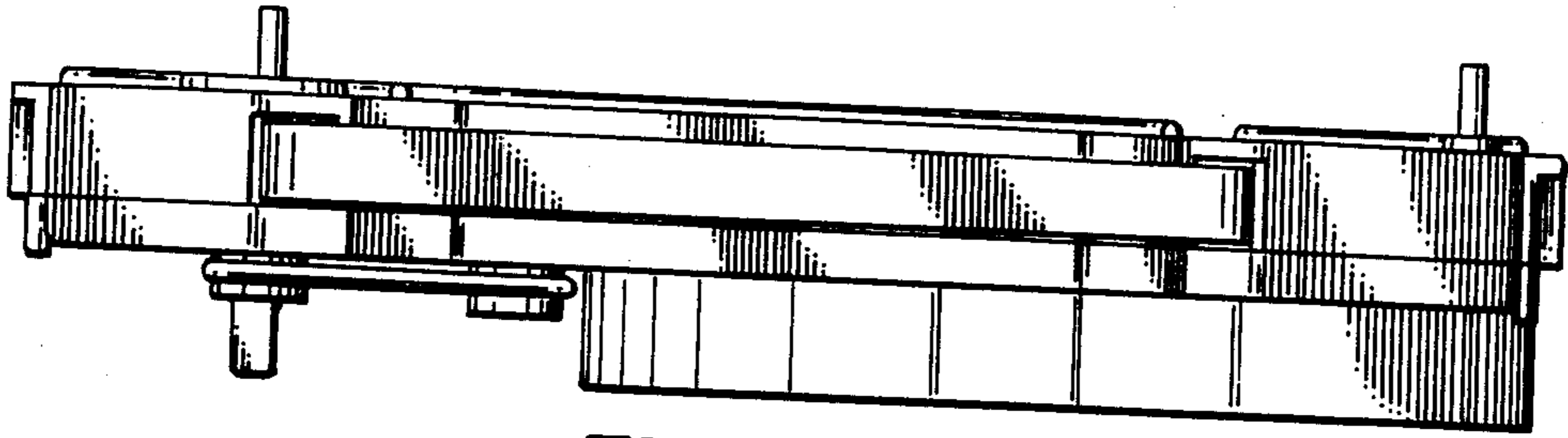

FIG. 6

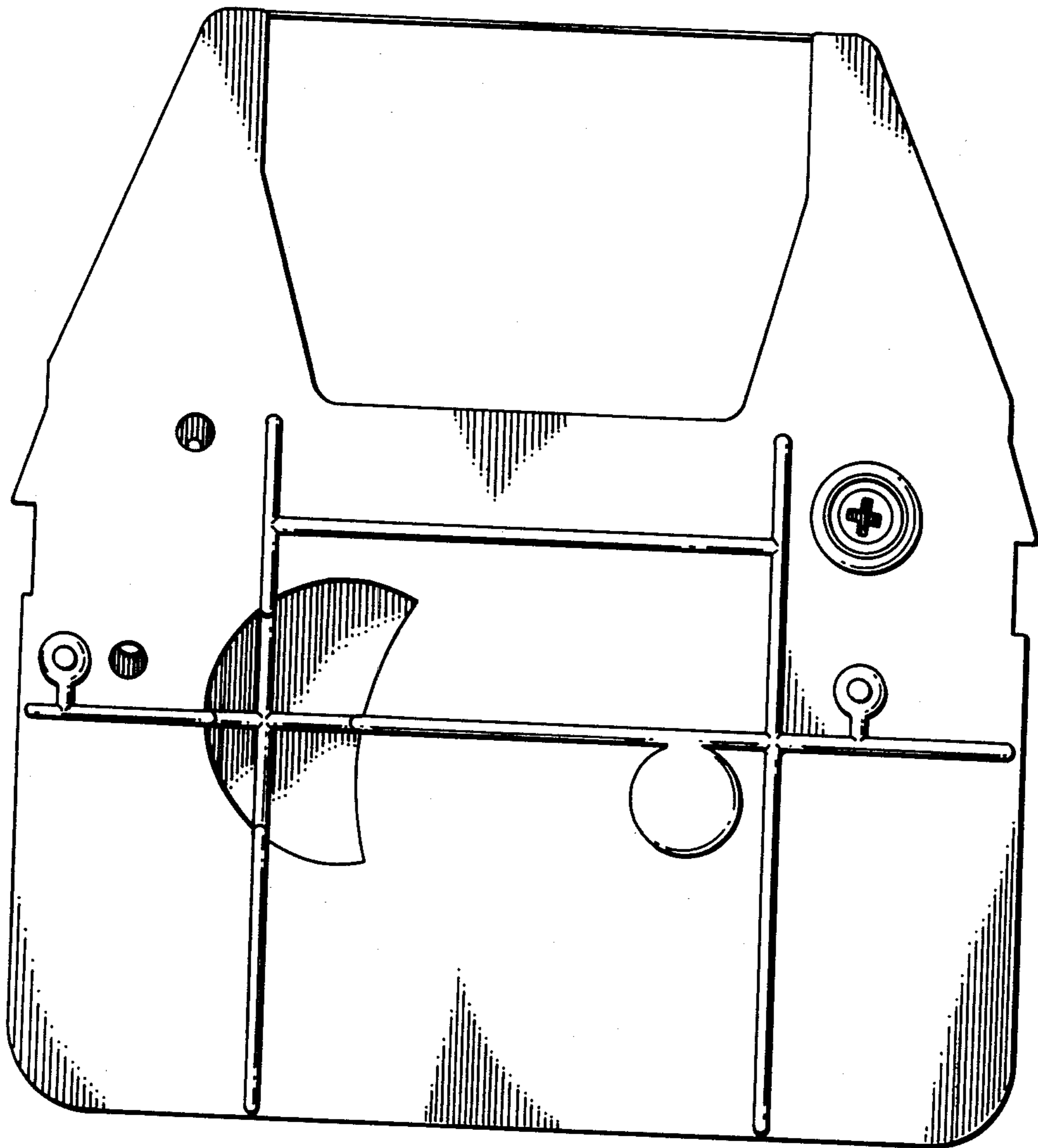

FIG. 4