

[54] MICROFILM READER/PRINTER OR THE LIKE

[75] Inventors: Andrew V. McClare, Rochester; Edward B. Schoonmaker, East Rochester, both of N.Y.

[73] Assignee: Eastman Kodak Company, Rochester, N.Y.

[\*\*] Term: 14 Years

[21] Appl. No.: 622,587

[22] Filed: Oct. 14, 1975

[51] Int. Cl. .... D16-03

[52] U.S. Cl. .... D16/28

[58] Field of Search ..... D16/14-18, D16/28; 353/11, 22, 23, 24, 25, 27, 39, 47, 74, 75, 77, 119, 122

[56] References Cited

U.S. PATENT DOCUMENTS

- 3,481,052 12/1969 Dorsett ..... 353/77
- 3,671,116 6/1972 Leutwein et al. .... 353/27 R

D. 212,226 9/1968 Dorsett ..... D56/4 D

OTHER PUBLICATIONS

British Journal of Photography, 12-1970, p. 1190, Optical Super-8 at bottom of page.

Primary Examiner—Joel Stearman  
Assistant Examiner—C. A. Rademaker  
Attorney, Agent, or Firm—R. W. Hampton

[57] CLAIM

The ornamental design for a microfilm reader/printer or the like, as shown and described.

DESCRIPTION

FIG. 1 is a front elevational view of a microfilm reader/printer showing our new design; FIG. 2 is a top plan view thereof; FIG. 3 is a right side elevational view thereof; FIG. 4 is a left side elevational view thereof; FIG. 5 is a rear elevational view thereof; FIG. 6 is a bottom plan view thereof; and FIG. 7 is a top, front and right side perspective view thereof.

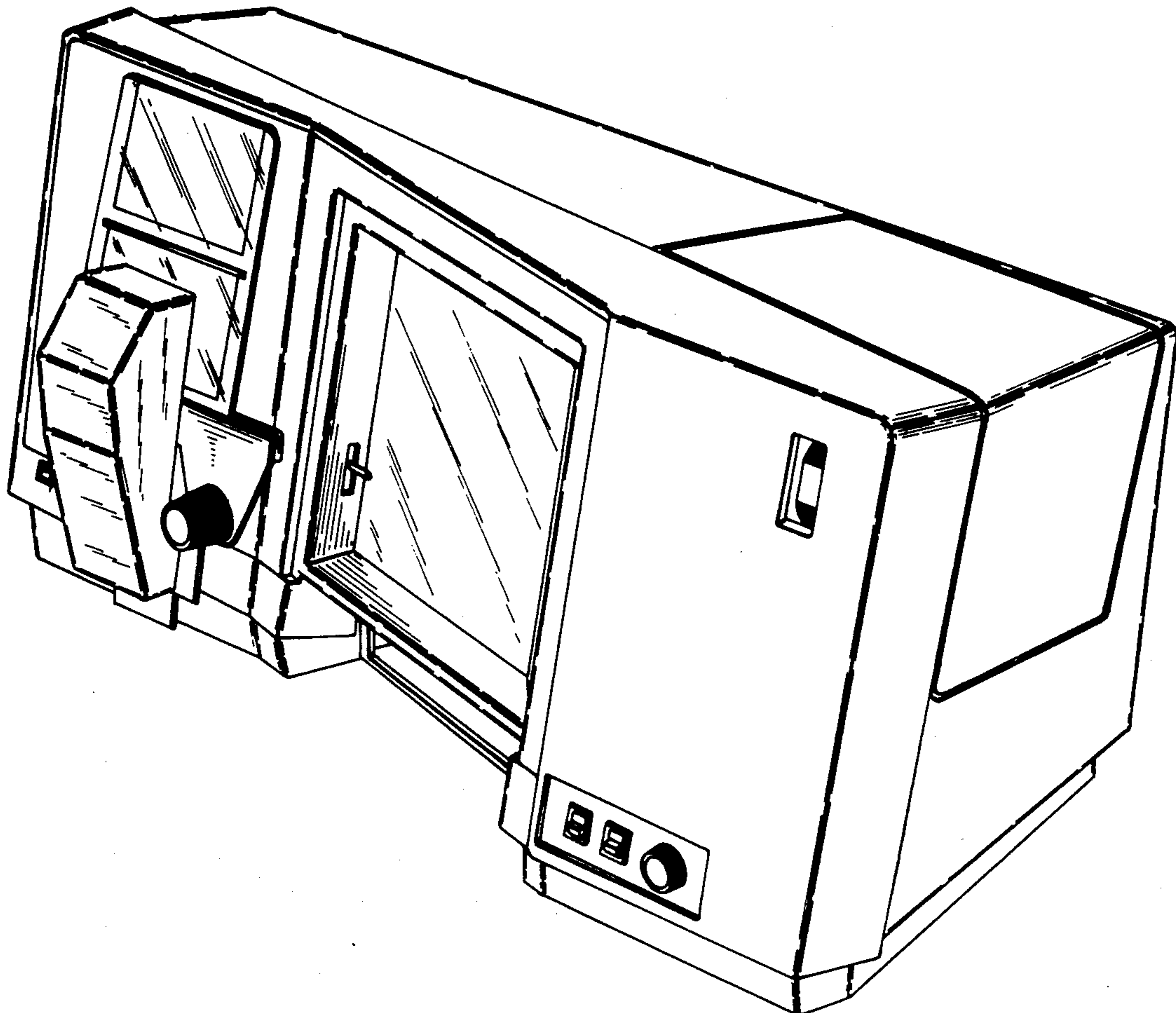

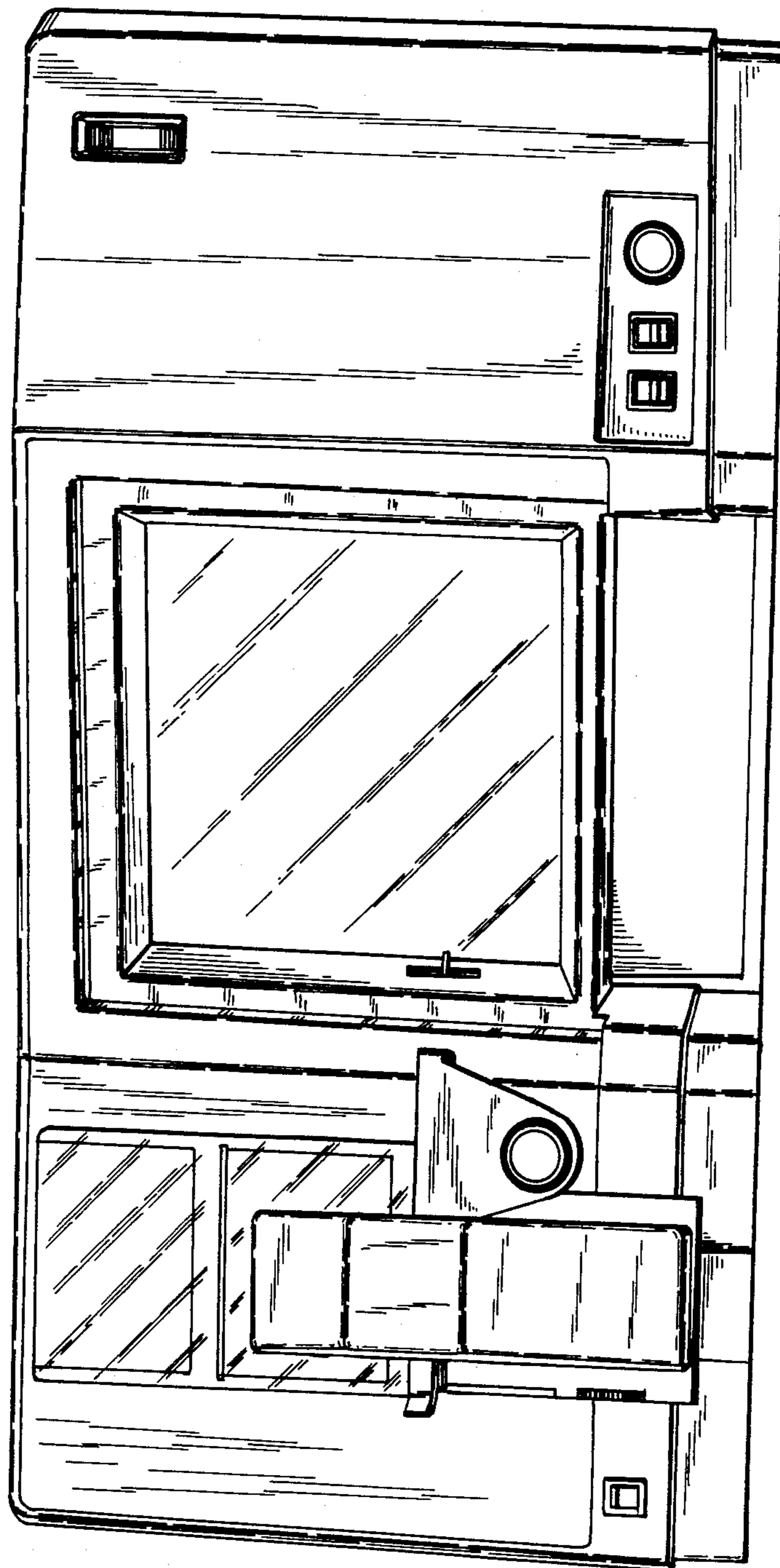

FIG. 1

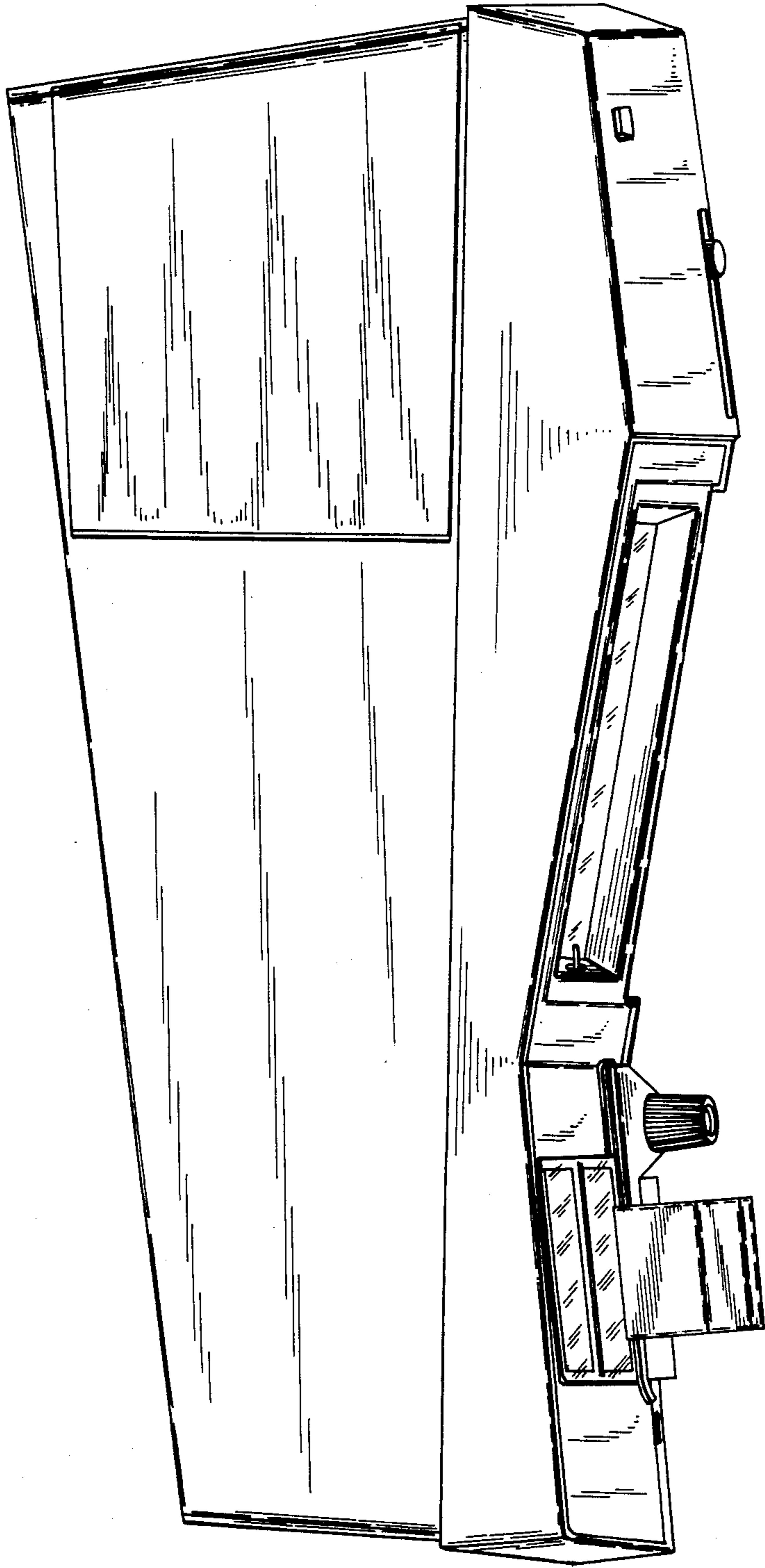

FIG. 2

FIG. 3

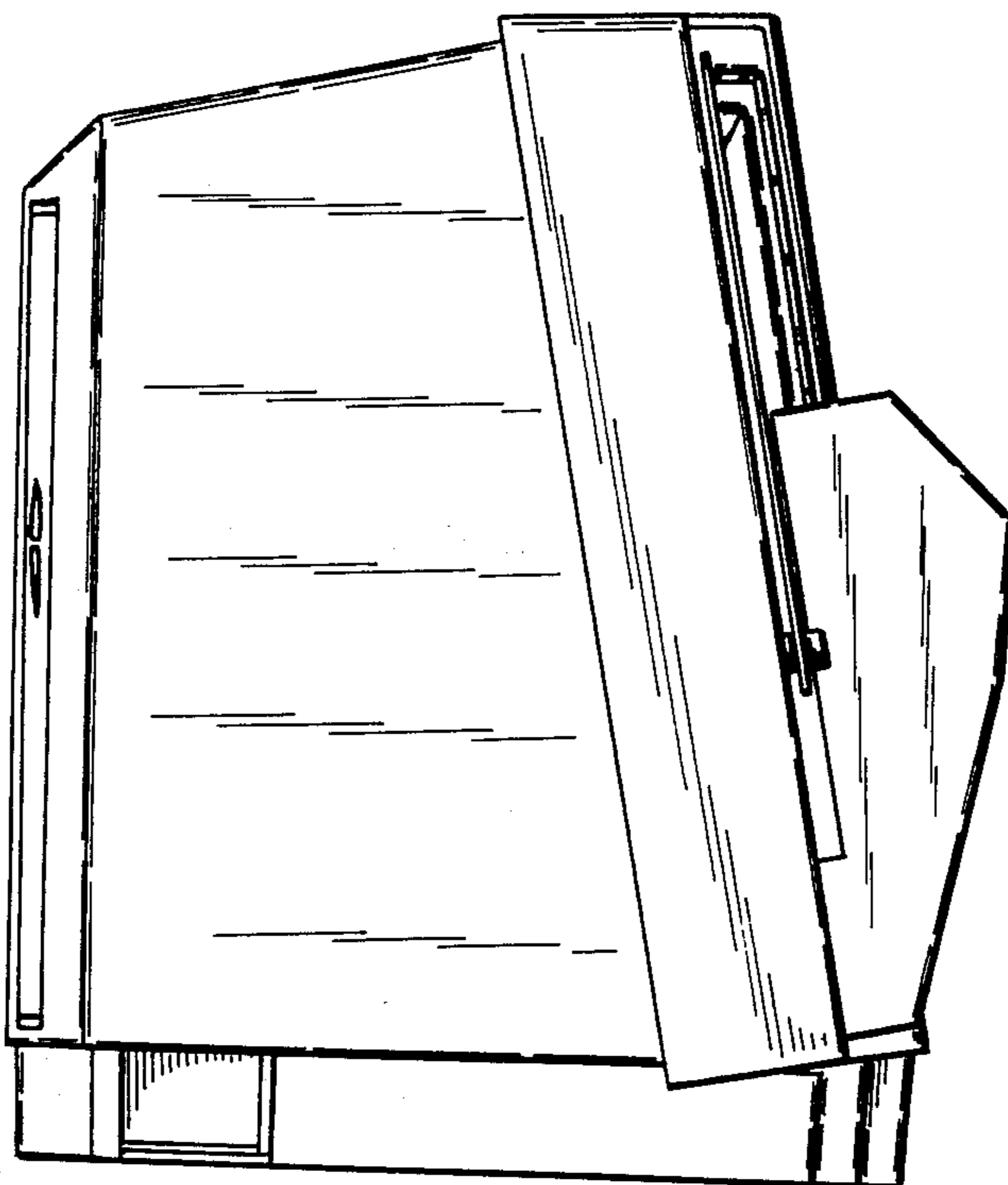
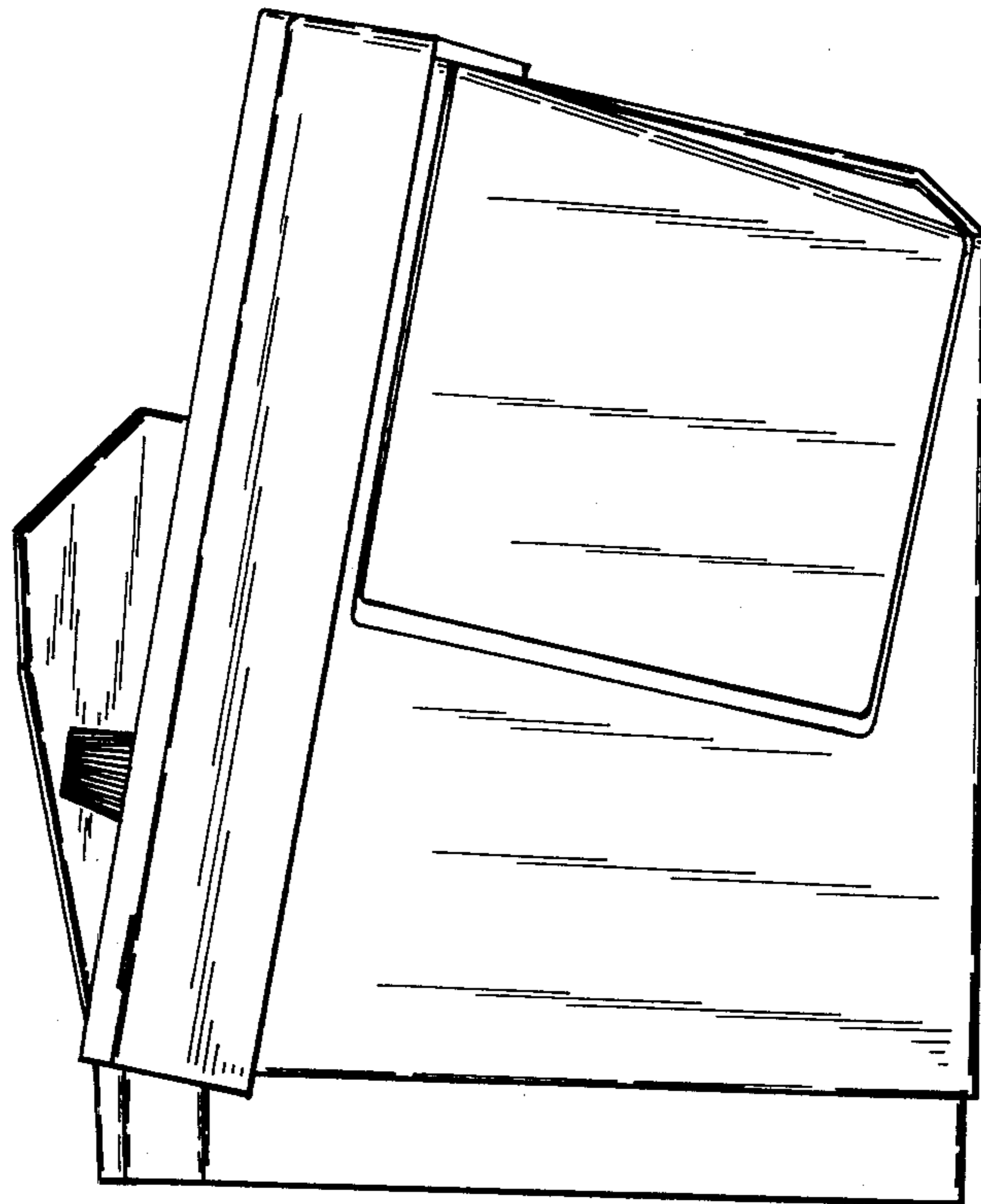

FIG. 4

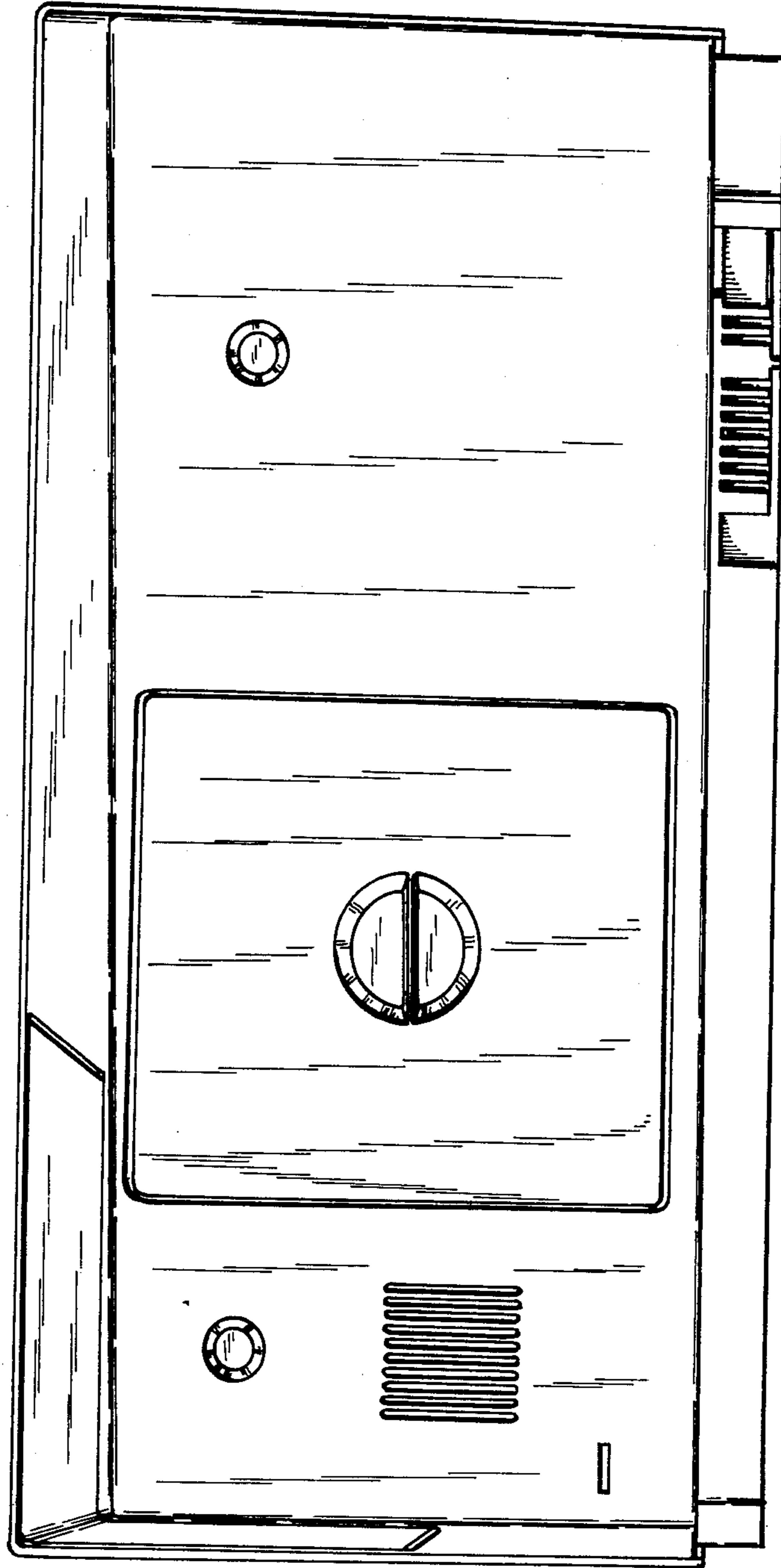
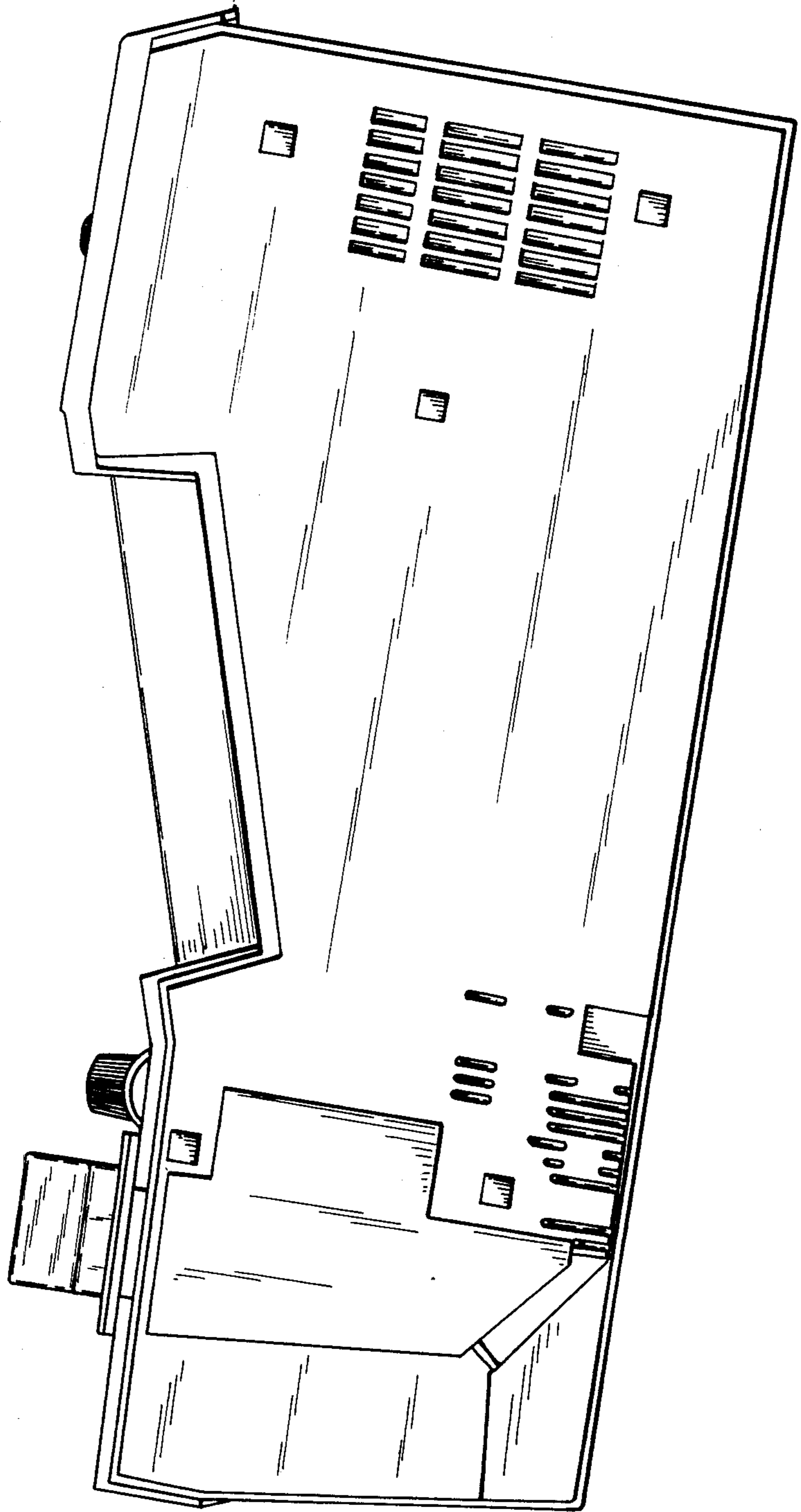

FIG. 5

FIG. 6



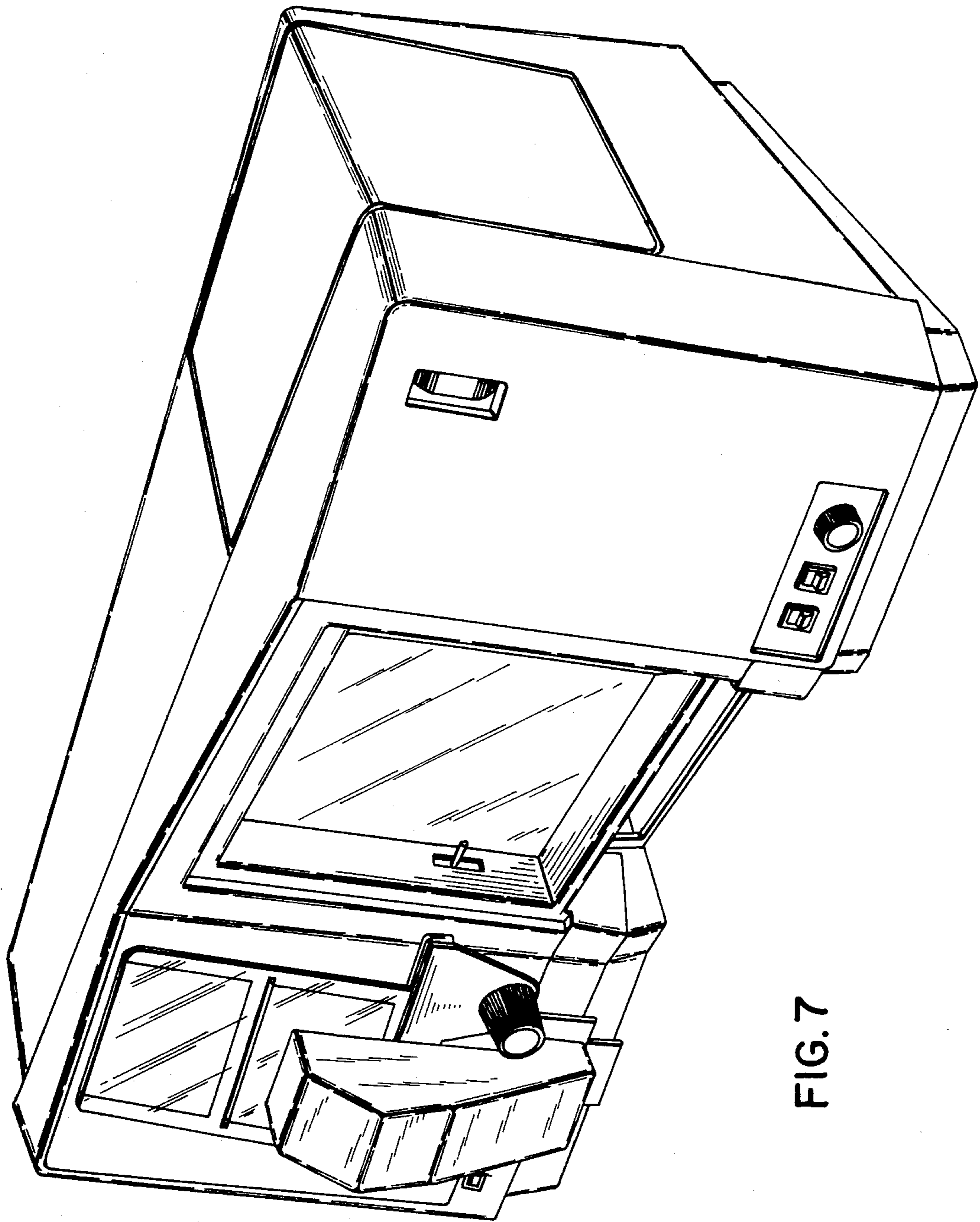

FIG. 7