

[54] CAMP STOVE

[75] Inventor: William Albert Folke, Upplands Vasby, Sweden

[73] Assignee: Aktiebolaget Optimus, Upplands Vasby, Sweden

[\*\*] Term: 14 Years

[21] Appl. No.: 555,252

[22] Filed: Mar. 4, 1975

[30] Foreign Application Priority Data

Sept. 4, 1974 Sweden ..... 1407/74

[51] Int. Cl. .... D7-04

[52] U.S. Cl. .... D7/110

[58] Field of Search ..... D7/107-110, D7/136; 126/25-29, 30, 27, 38, 9, 39, 43, 44, 41

[56] References Cited

U.S. PATENT DOCUMENTS

D. 120,152	4/1940	Tullis .....	D7/110
D. 229,277	11/1973	Chan .....	D7/110
D. 236,418	8/1975	Duperow et al. ....	D7/136
D. 236,867	9/1975	Horholt .....	D7/136

Primary Examiner—Wallace R. Burke  
Assistant Examiner—Catherine Kemper  
Attorney, Agent, or Firm—Young & Thompson

[57] CLAIM

The ornamental design for a camp stove, as shown and described.

DESCRIPTION

FIG. 1 is a side elevational view of a camp stove showing my new design;  
FIG. 2 is a view thereof from the right side of FIG. 1;  
FIG. 3 is a top plan view thereof;  
FIG. 4 is a bottom plan view thereof;  
FIG. 5 is a top perspective view thereof; and  
FIG. 6 is a bottom perspective view thereof.

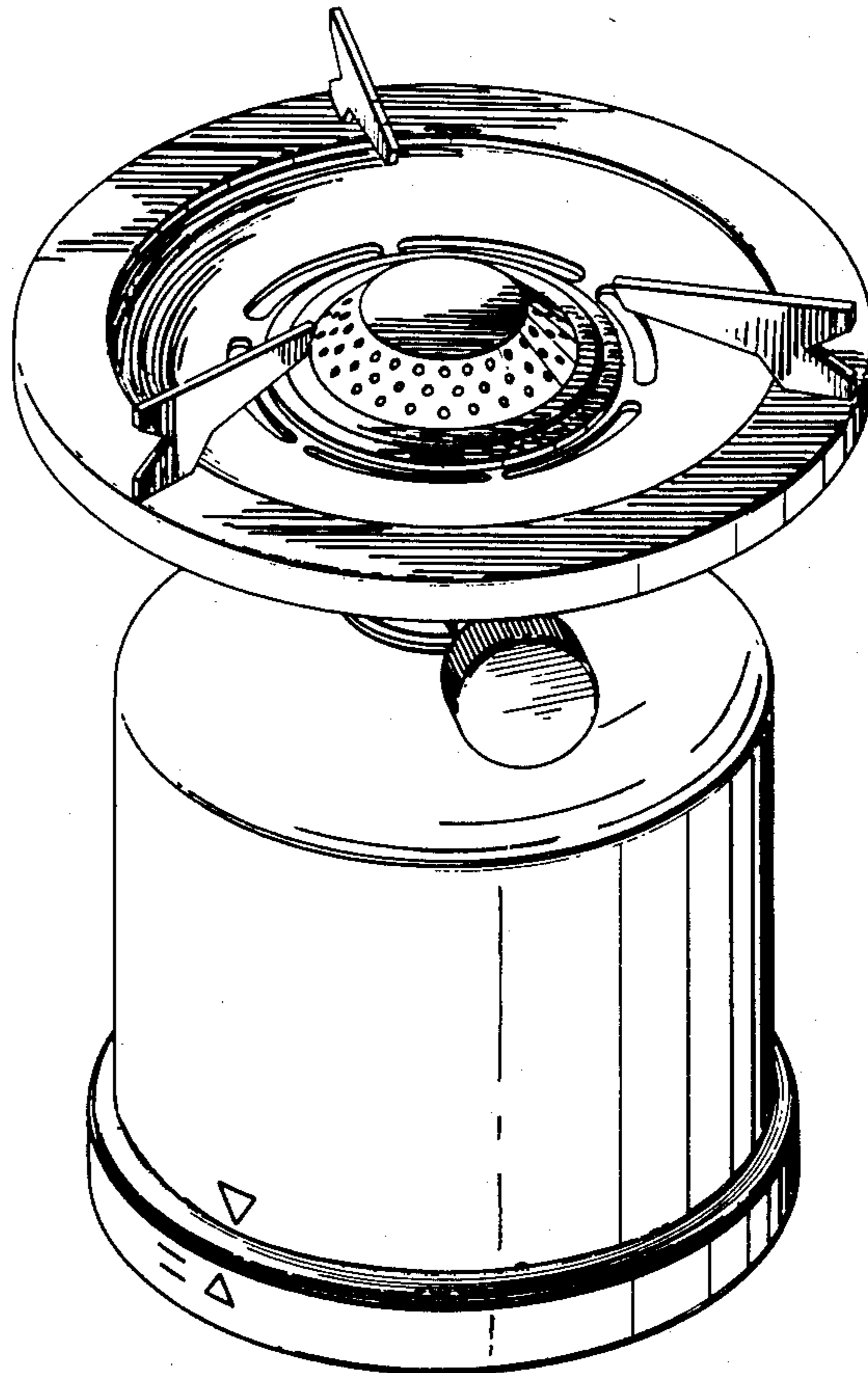
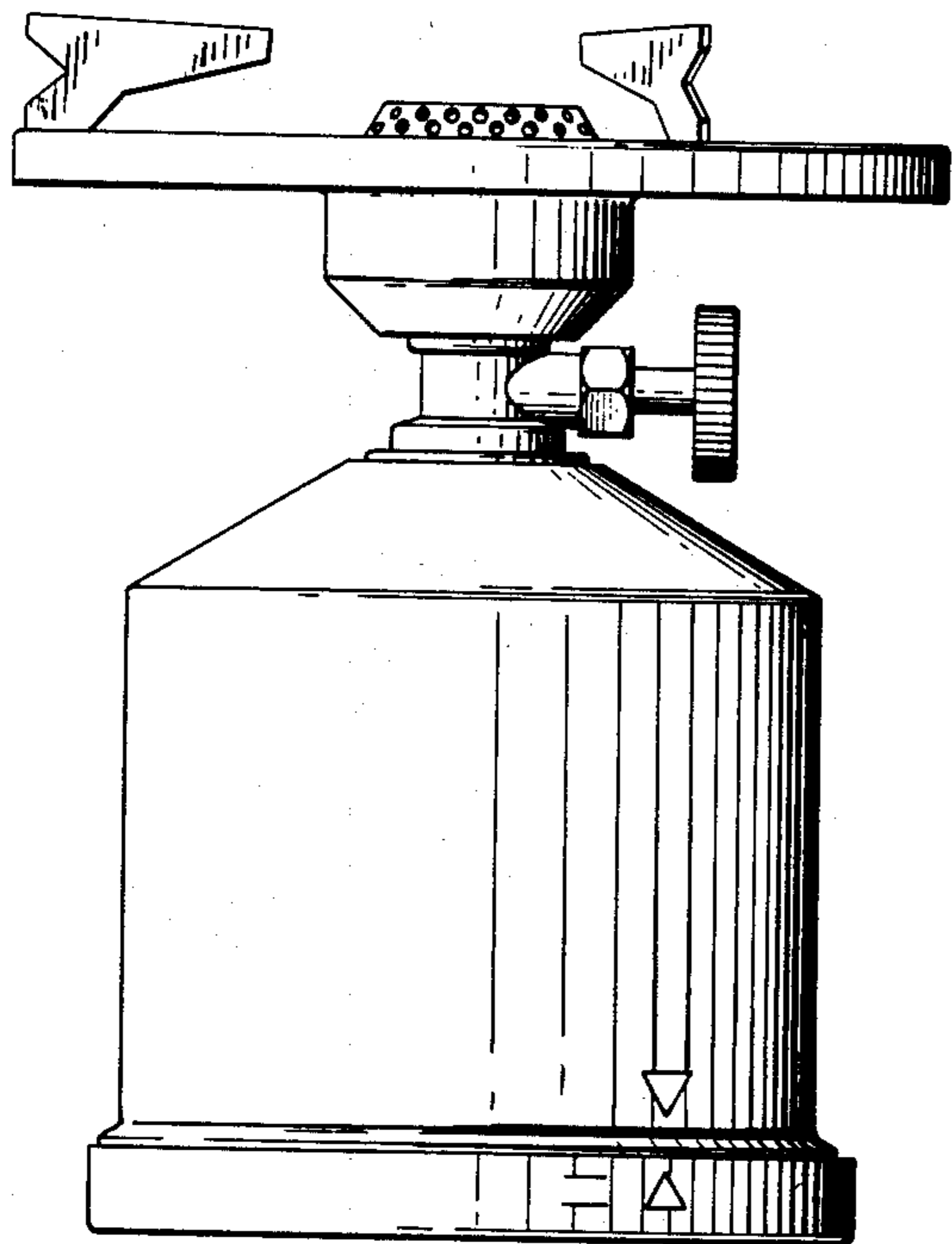

**FIG. 1**

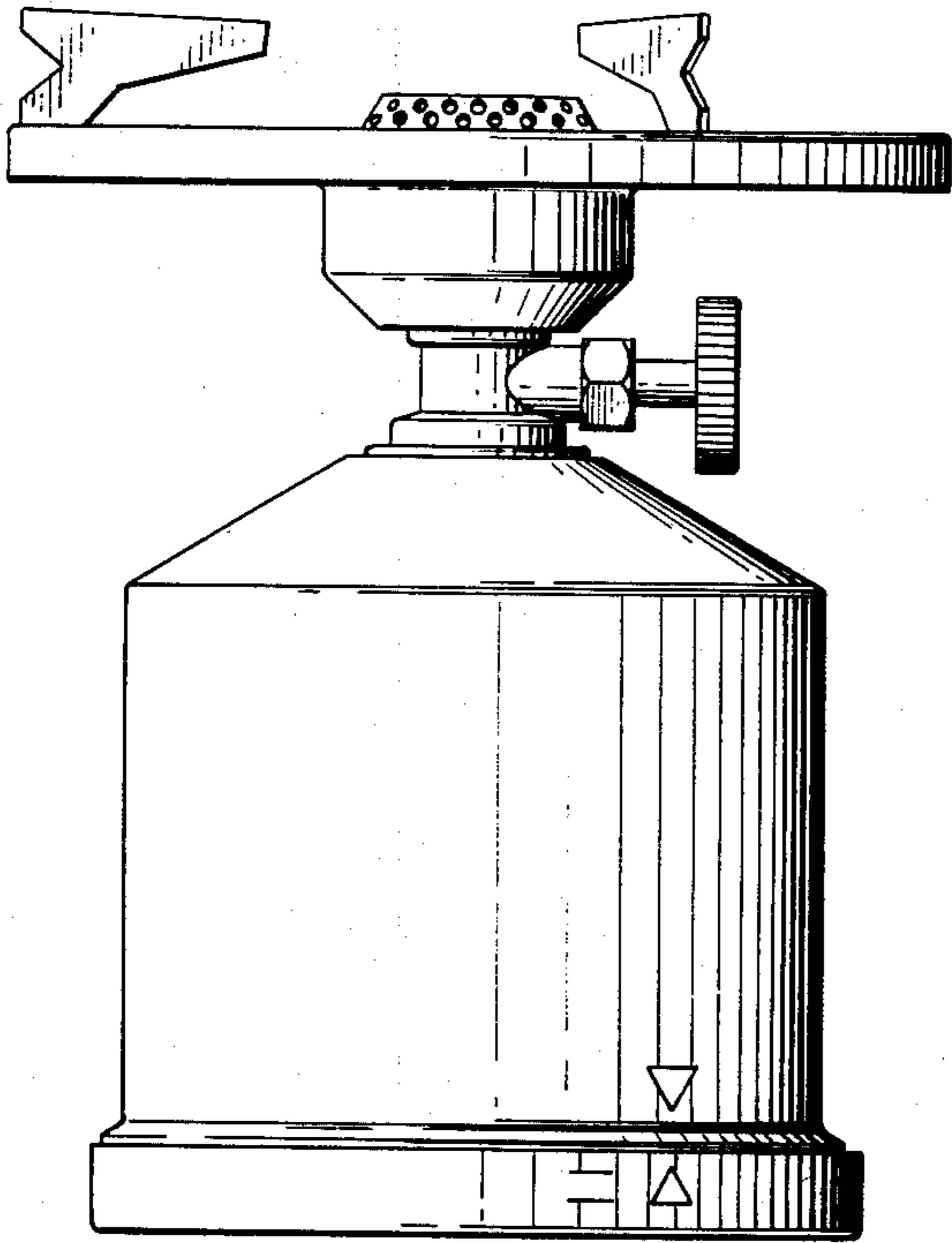

**FIG. 2**

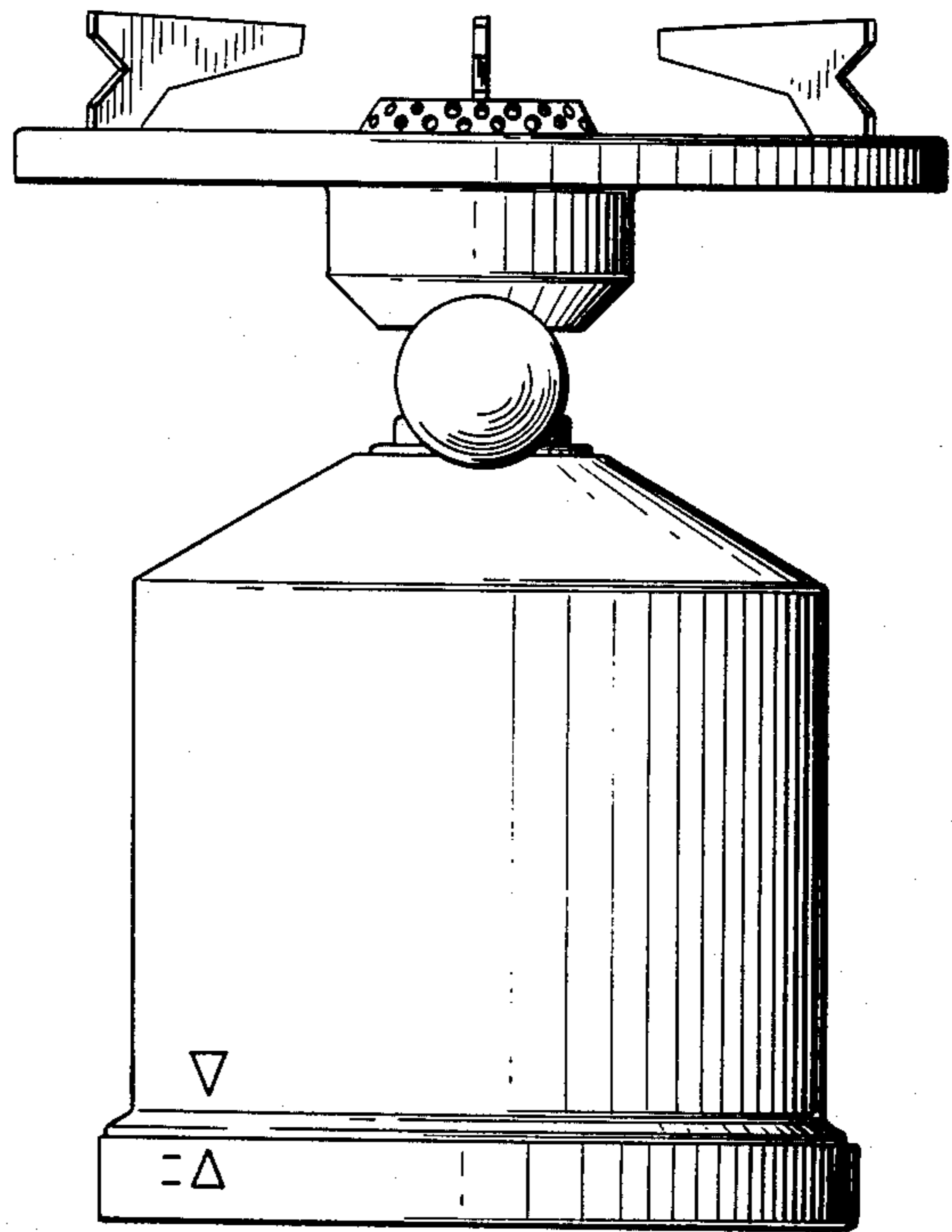

**FIG. 3**

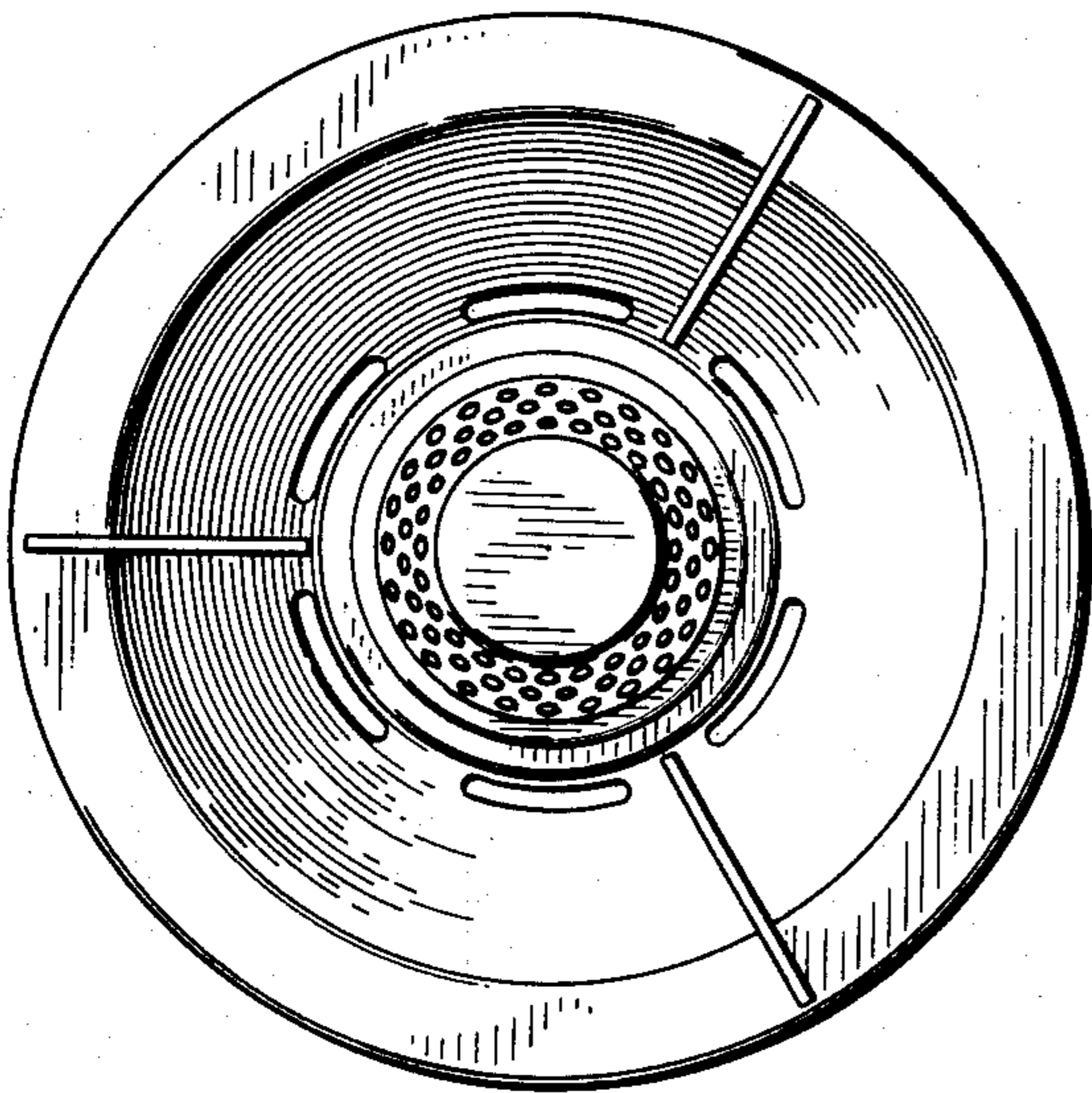

**FIG. 4**

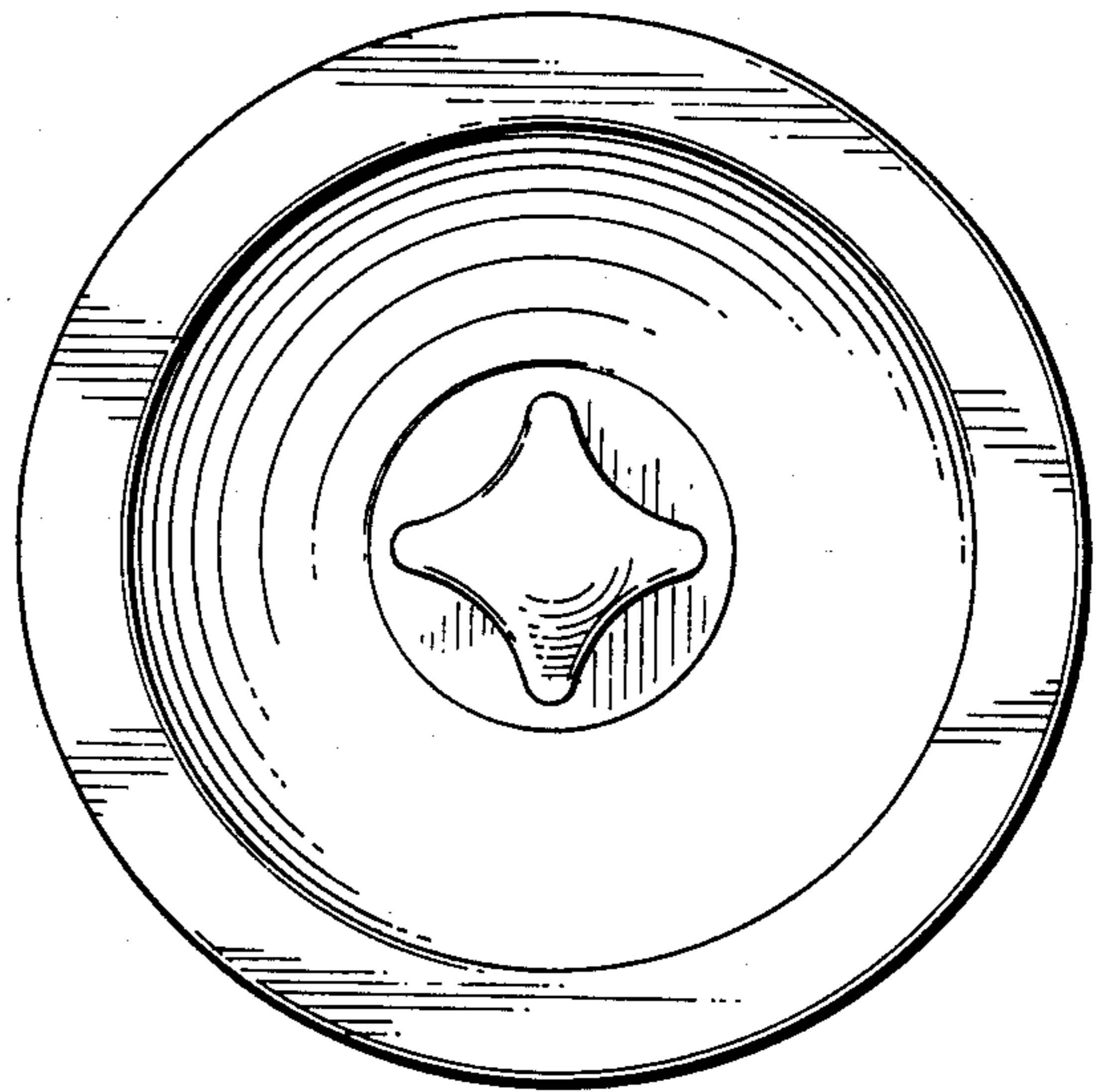

FIG 6

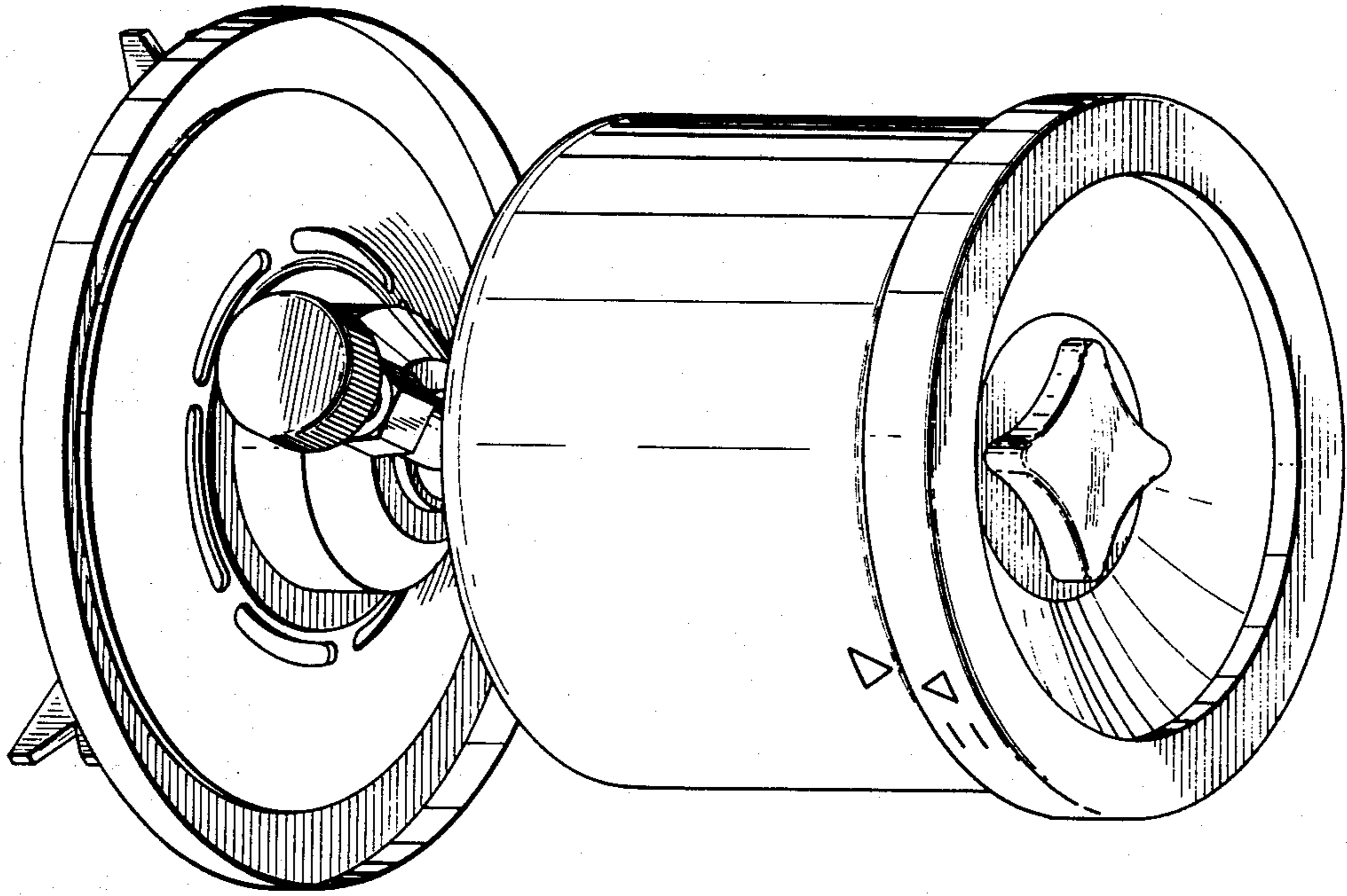

FIG 5

