

[54] RIBBON CONTAINER

[76] Inventor: Dale R. Hodges, 4103 Inwood Road, Dallas, Tex. 75209

[**] Term: 14 Years

[21] Appl. No.: 599,475

[22] Filed: July 28, 1975

[51] Int. Cl. D9-03

[52] U.S. Cl. D9/238

[58] Field of Search D87/1 R, 1 B, 1 C, 1 D, D87/5 D, 5 E; D3/19 B; 229/8; D7/77, 83, 84; D9/216, 222-240; 206/457

[56] References Cited

U.S. PATENT DOCUMENTS

1,735,191	11/1929	Weisenberg	229/8
2,780,403	2/1957	James	206/457
D. 107,793	1/1938	Rathbun	D9/239
D. 142,181	8/1945	Coleman	D9/238
D. 238,978	2/1976	Getchell et al.	D87/1 R

OTHER PUBLICATIONS

Vogue, Dec. 1, 1936, p. 119, item: bottom right corner.

Primary Examiner—Joel Stearman

Assistant Examiner—George P. Word

Attorney, Agent, or Firm—D. Carl Richards

[57] CLAIM

The ornamental design for a ribbon container, substantially as shown and described.

DESCRIPTION

FIG. 1 is a perspective view of a ribbon container showing my new design;

FIG. 2 is a reduced scale top plan view;

FIG. 3 is a front elevational view thereof;

FIG. 4 is a left side elevational view;

FIG. 5 is a right side elevational view;

FIG. 6 is a rear elevational view.

FIG. 7 is a bottom plan view thereof;

FIG. 8 is a perspective view of the container with the lid removed; and

FIG. 9 is a perspective view of the lid removed from the container.





FIG. 1

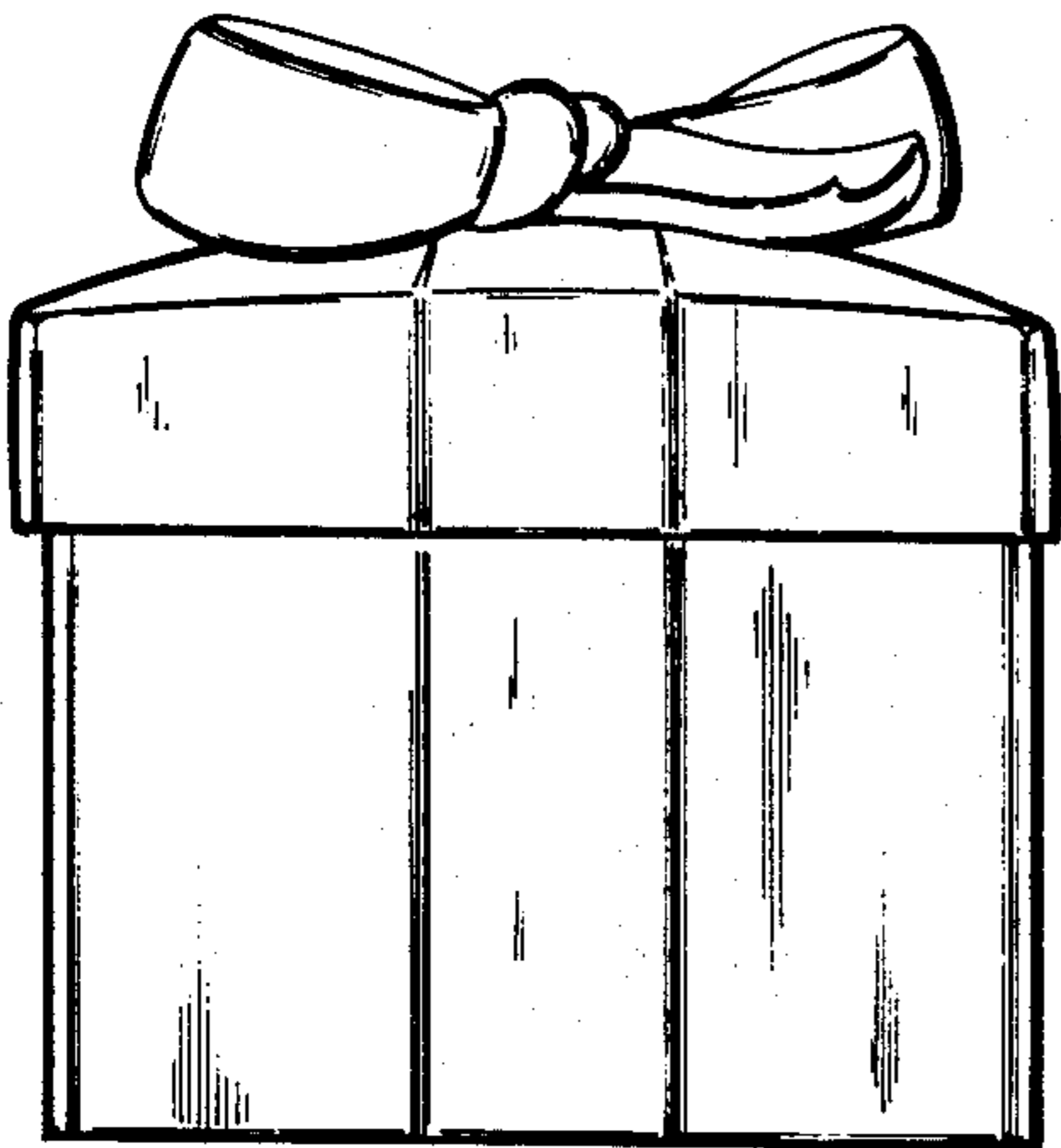

FIG. 3



FIG. 2

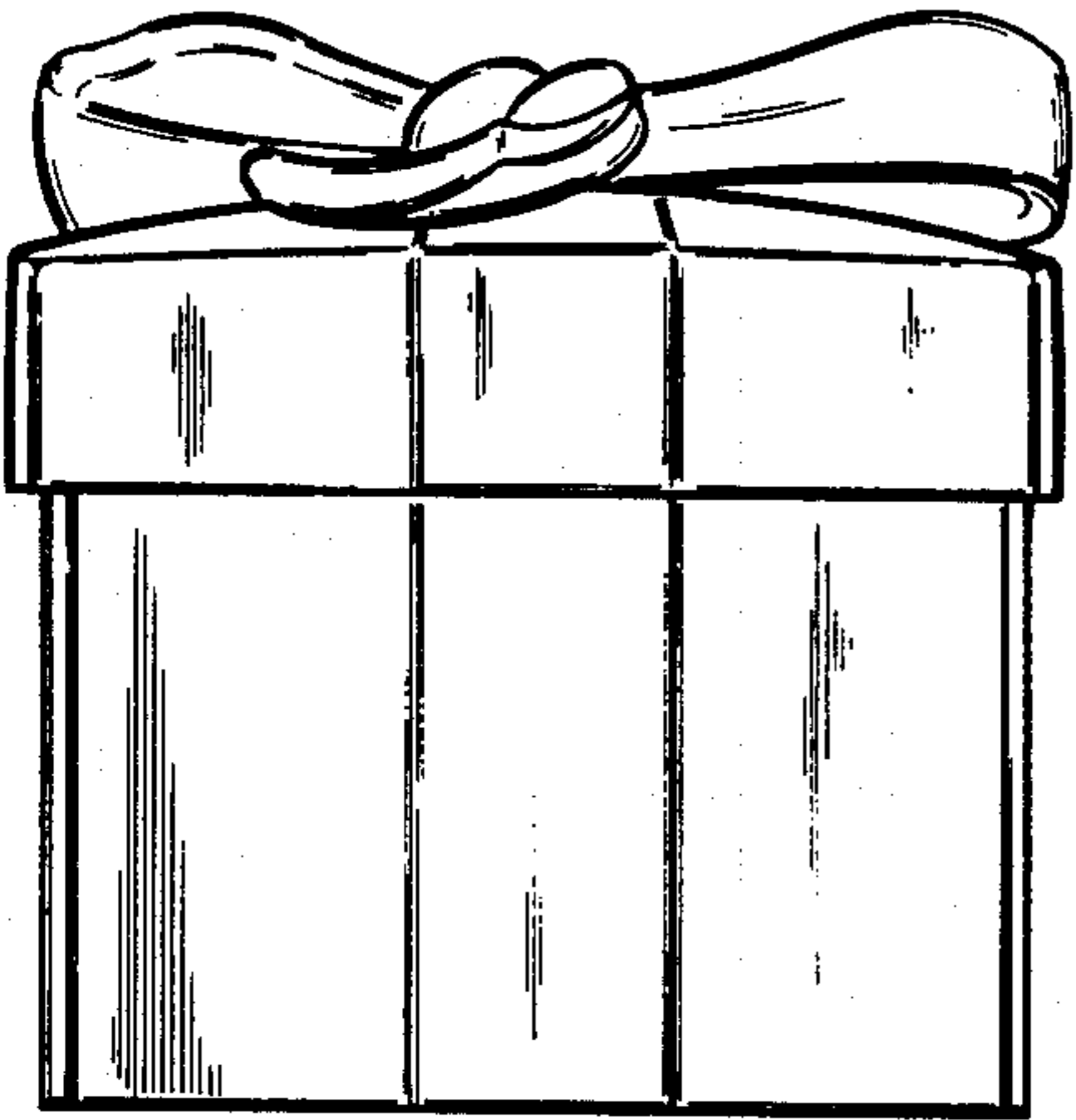

FIG. 4

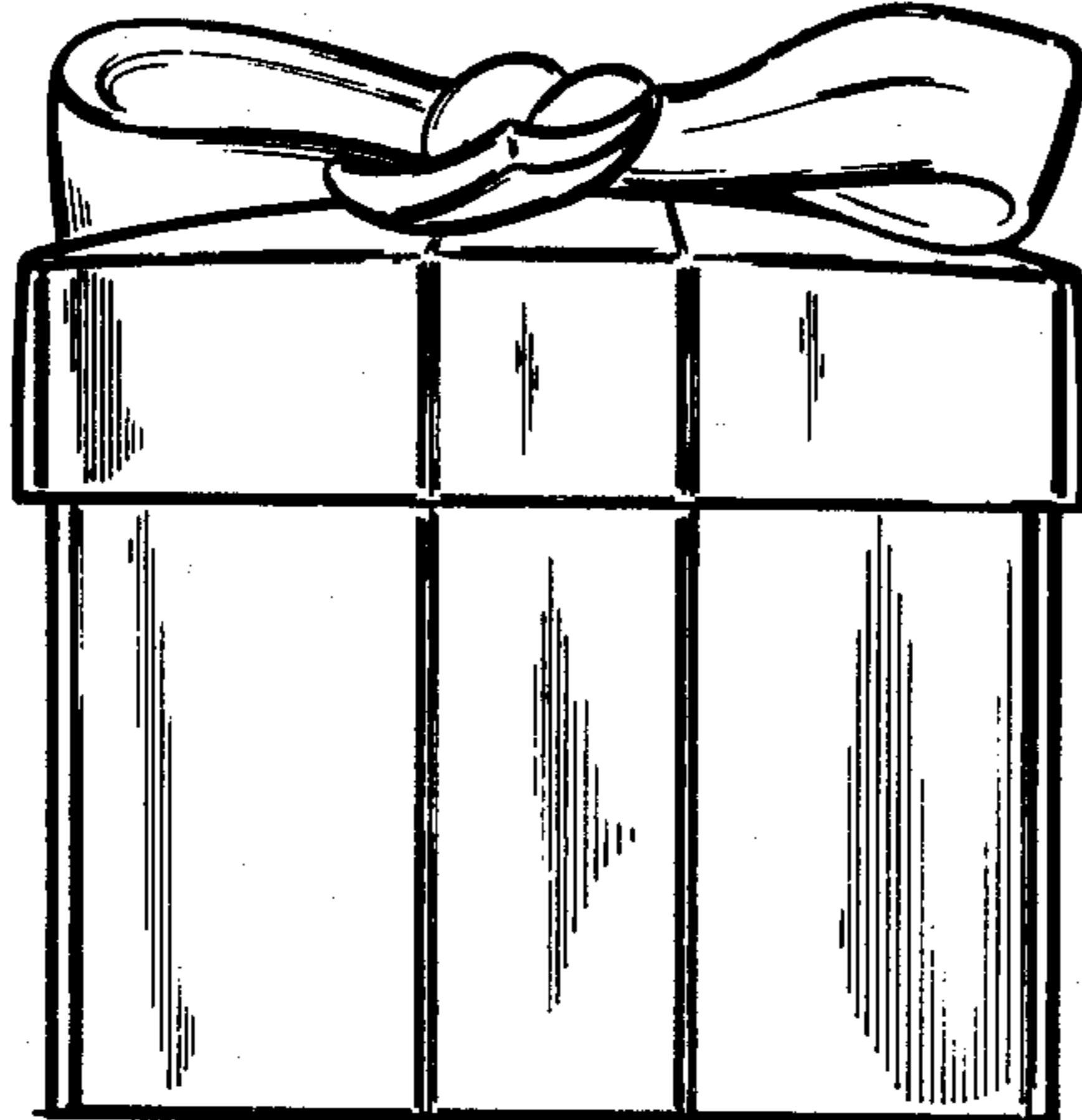

FIG. 5

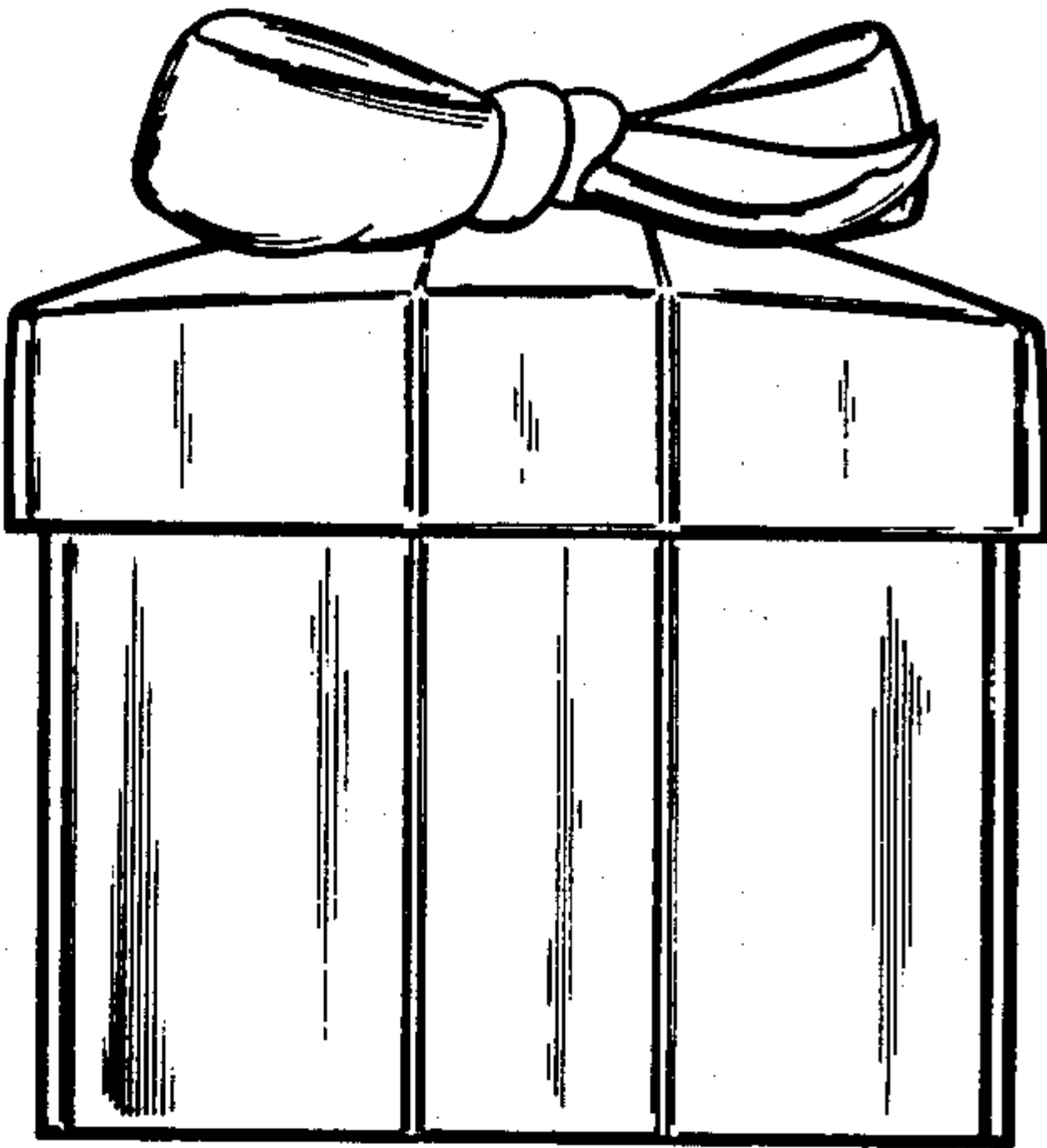

FIG. 6

FIG. 7

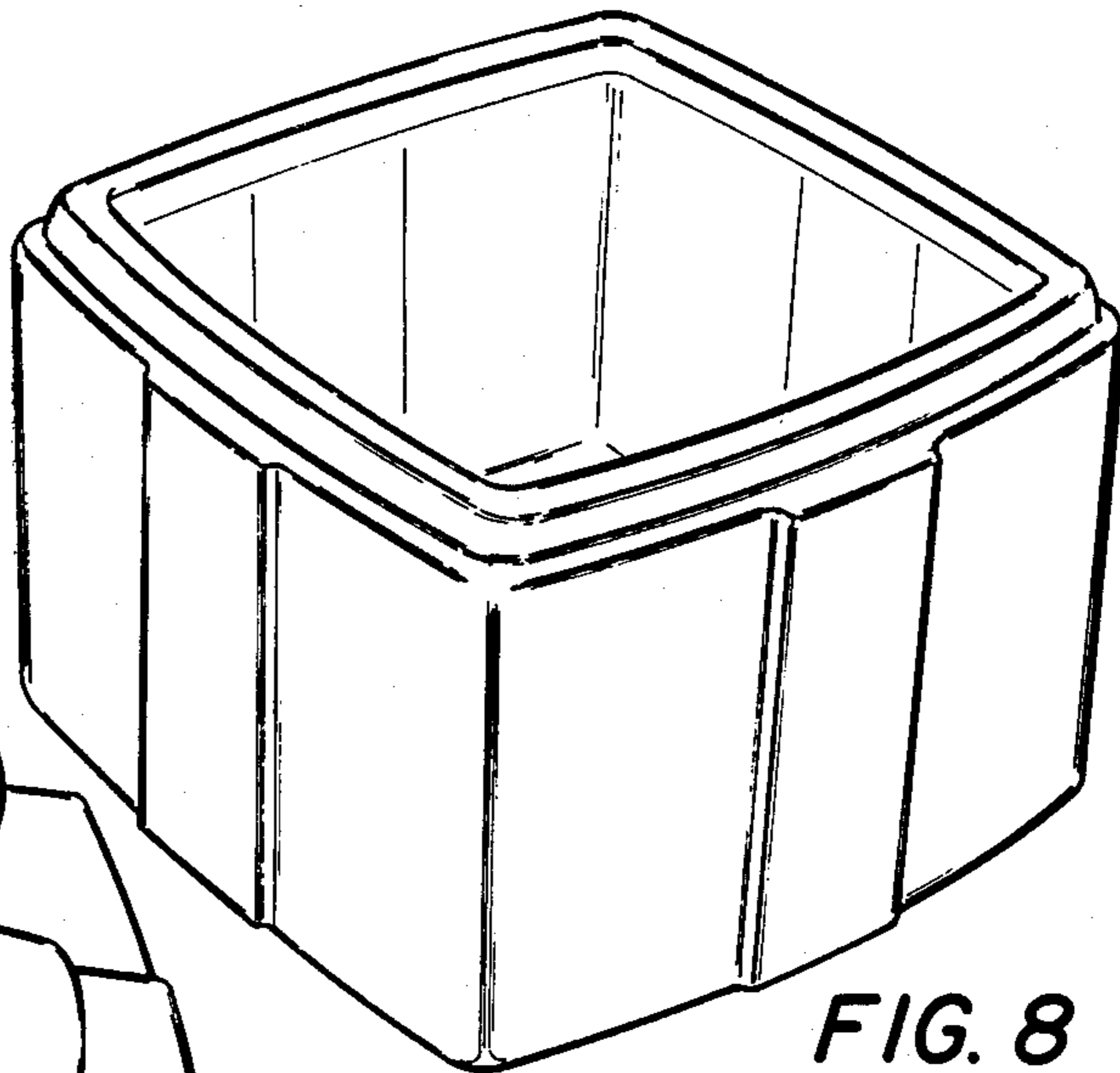
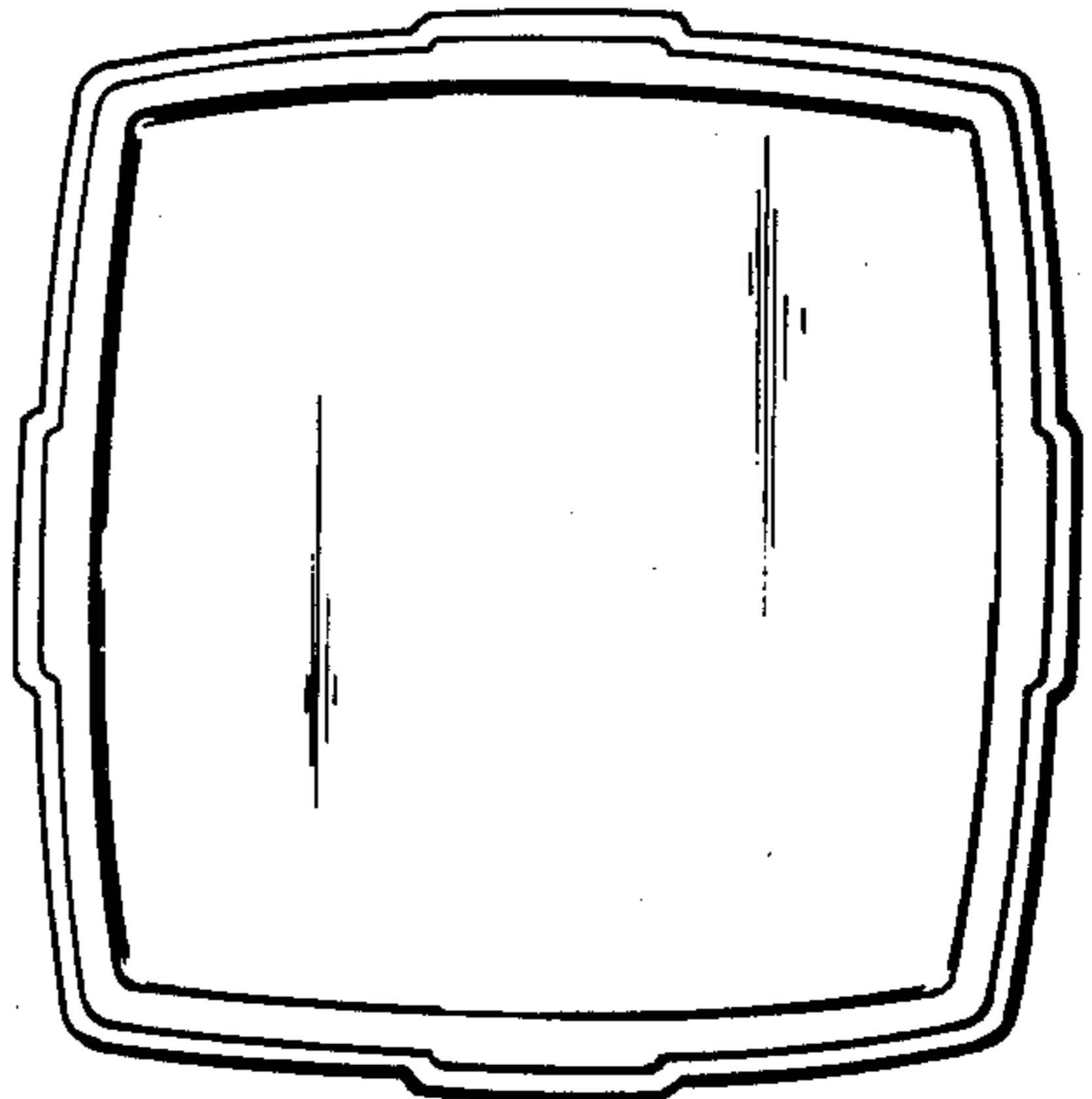

FIG. 8

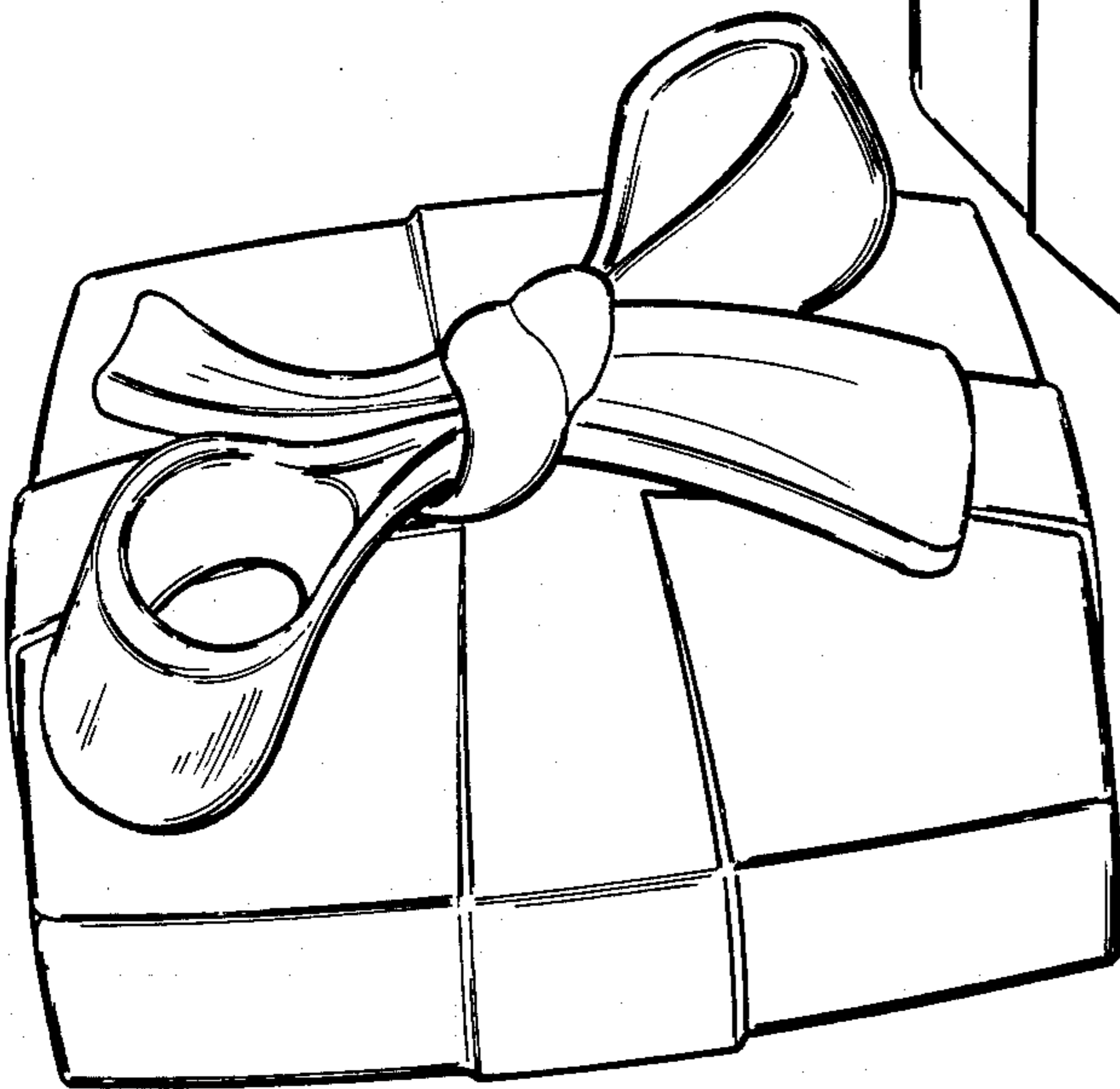

FIG. 9