

[54] CUP AND SAUCER COMBINATION

[75] Inventor: Sven-Eric Juhlin, Ingaro, Sweden

[73] Assignee: Aktiebolaget Gustavsbergs Fabriker, Gustavsberg, Sweden

[**] Term: 14 Years

[21] Appl. No.: 665,303

[22] Filed: Mar. 9, 1976

[30] Foreign Application Priority Data

Sept. 24, 1975 Sweden 751871

[51] Int. Cl. D7-01

[52] U.S. Cl. D7/3

[58] Field of Search 220/23.83, 23.86; 206/502; D7/23, 2, 3, 4, 45, 6-15, 22

[56] References Cited

U.S. PATENT DOCUMENTS

2,755,644	7/1956	Watson	D7/3 X
2,932,437	4/1960	Wilcox	D7/9 X
3,123,273	3/1964	Miller	D7/9 X
D. 101,958	11/1936	Kogan	D7/9
D. 210,476	3/1968	Gulotta	D7/3
D. 227,532	7/1973	Refsgaard	D7/9

FOREIGN PATENT DOCUMENTS

539,522 4/1957 Canada 220/23.83

OTHER PUBLICATIONS

Housewares, Dec. 1971, p. 44, insulated mug shown at top left panel-Happy Face/Smile.

Primary Examiner—Winifred E. Herrmann

Attorney, Agent, or Firm—David Toren

[57] CLAIM

The ornamental design for a cup and saucer combination, as shown.

DESCRIPTION

FIG. 1 is a perspective view of a cup and saucer combination showing my new design;

FIG. 2 is a top plan view thereof of the cup with the saucer removed;

FIG. 3 is a side elevational view of the cup;

FIG. 4 is an end elevational view of the cup;

FIG. 5 is a bottom plan view of the cup;

FIG. 6 is a top plan view of the saucer with the cup removed;

FIG. 7 is an elevational view of the saucer; and

FIG. 8 is a bottom plan view of the saucer.

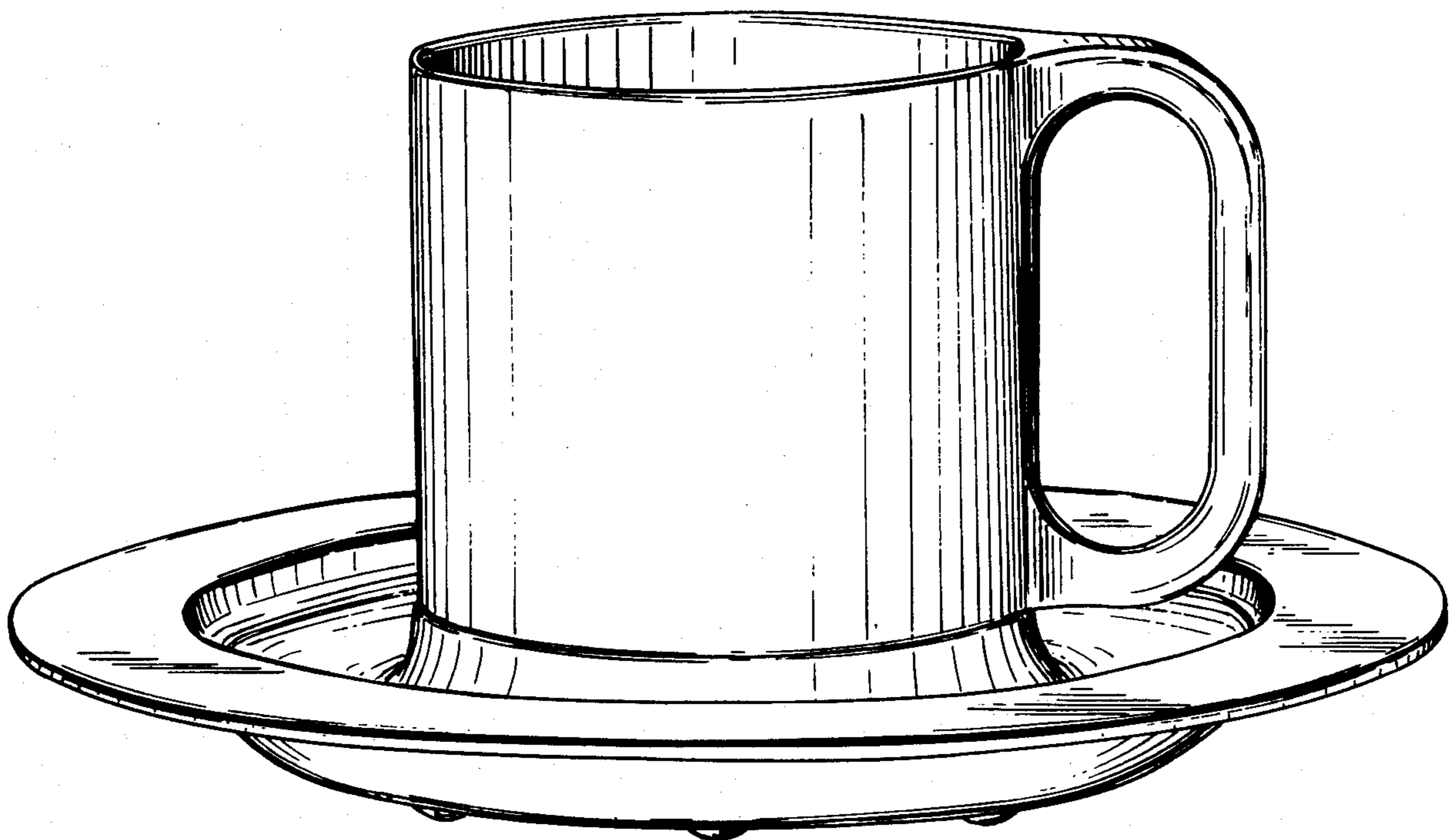

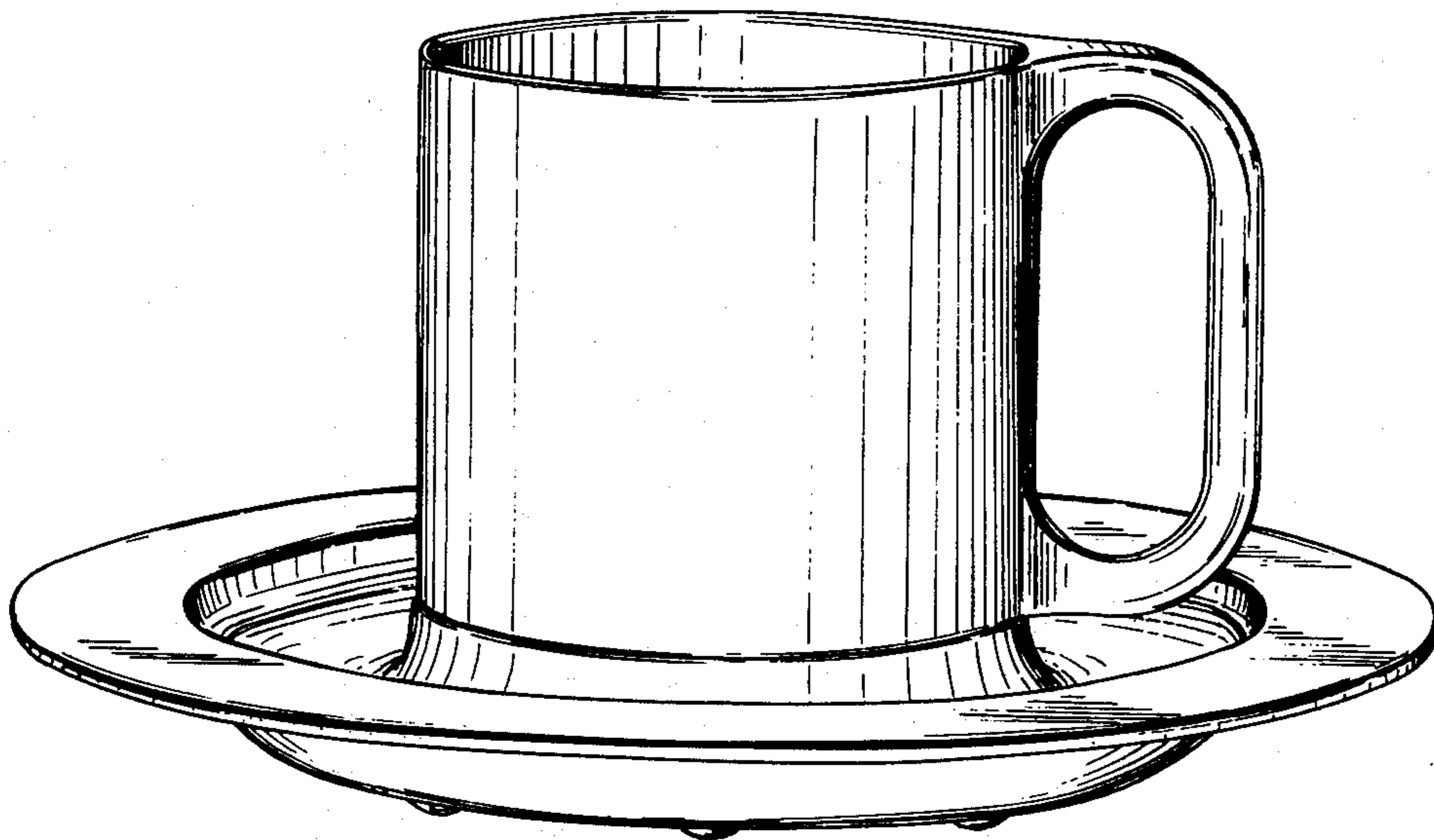

FIG. 1

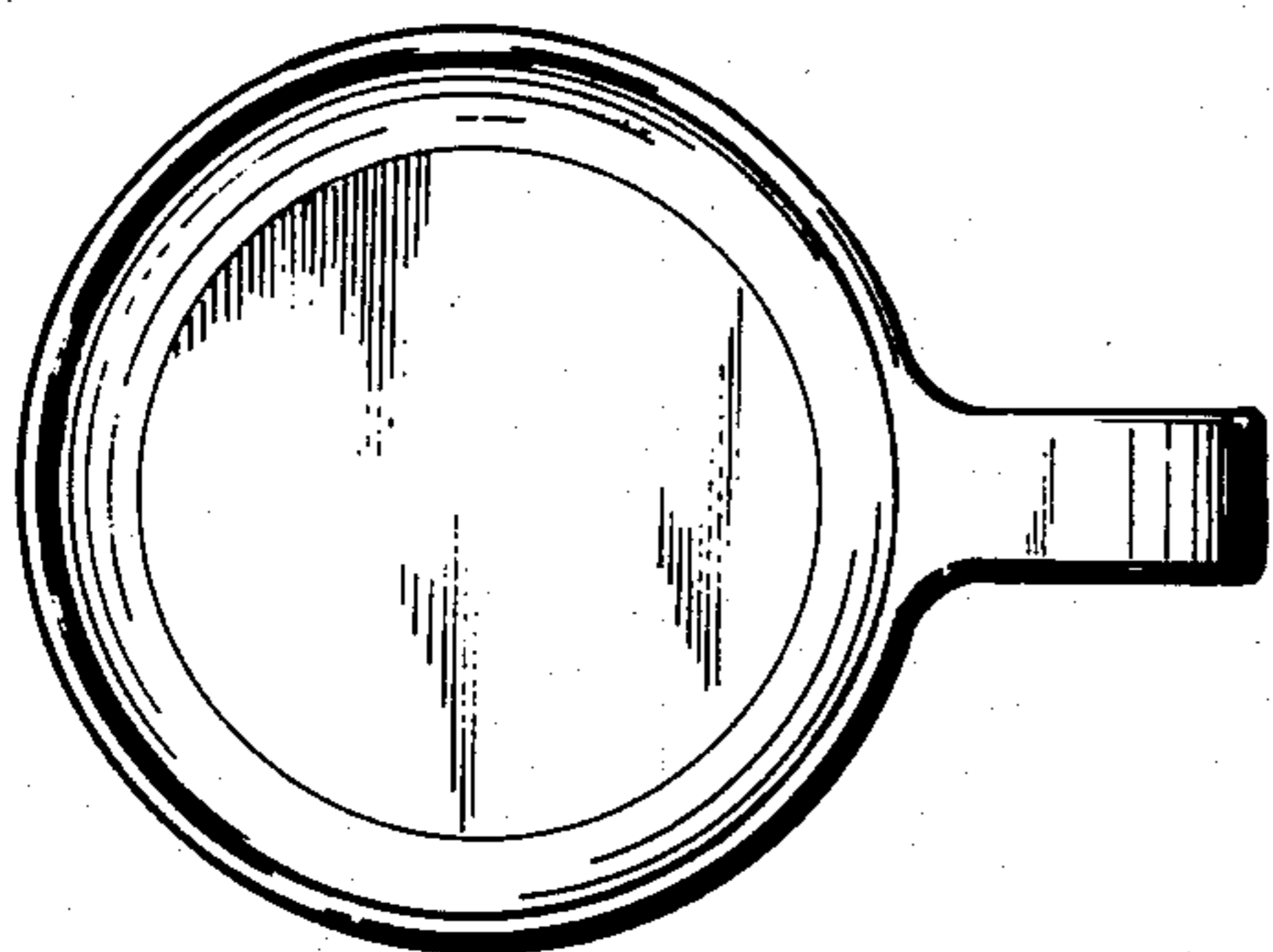

FIG. 2

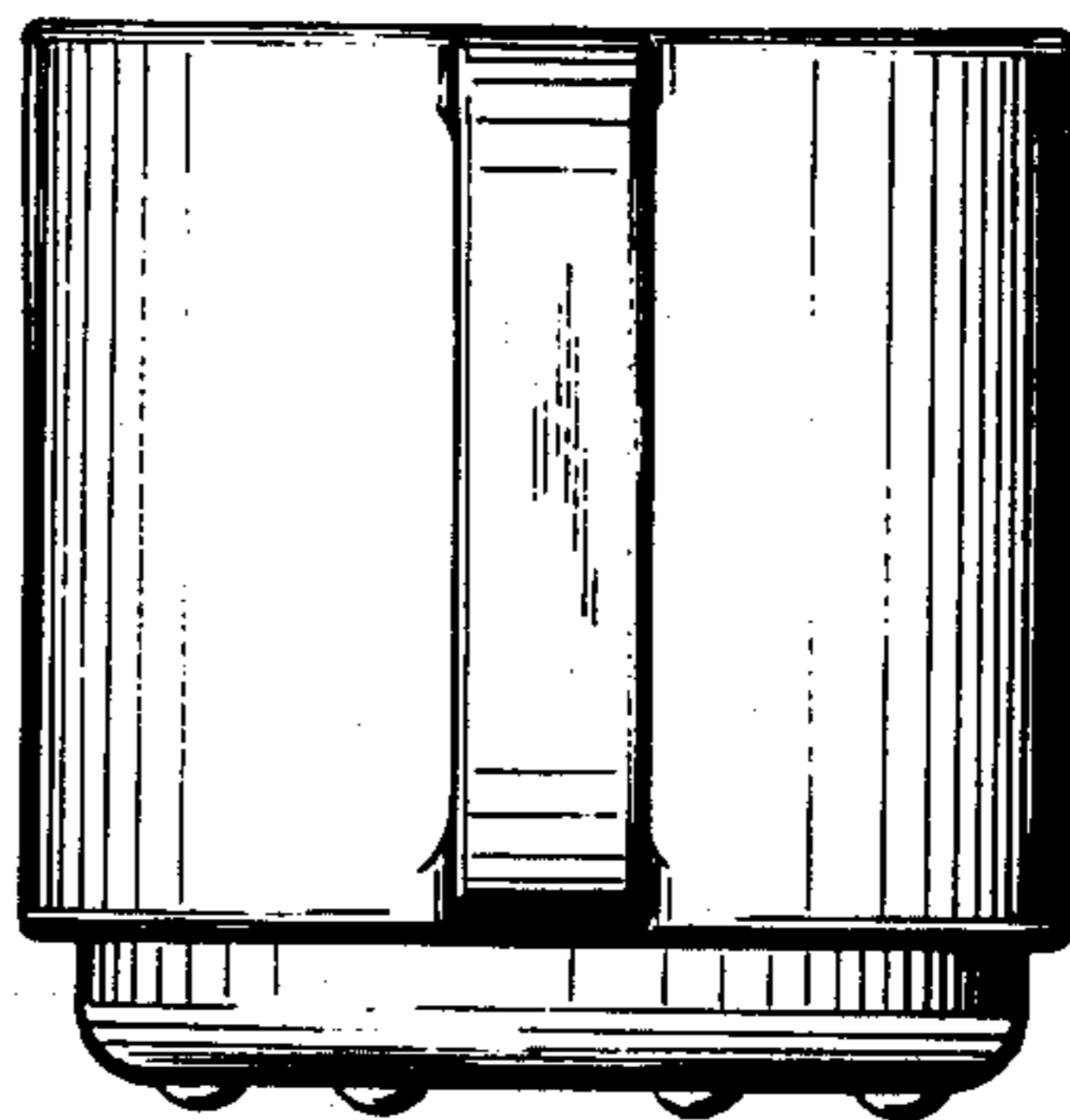

FIG. 4

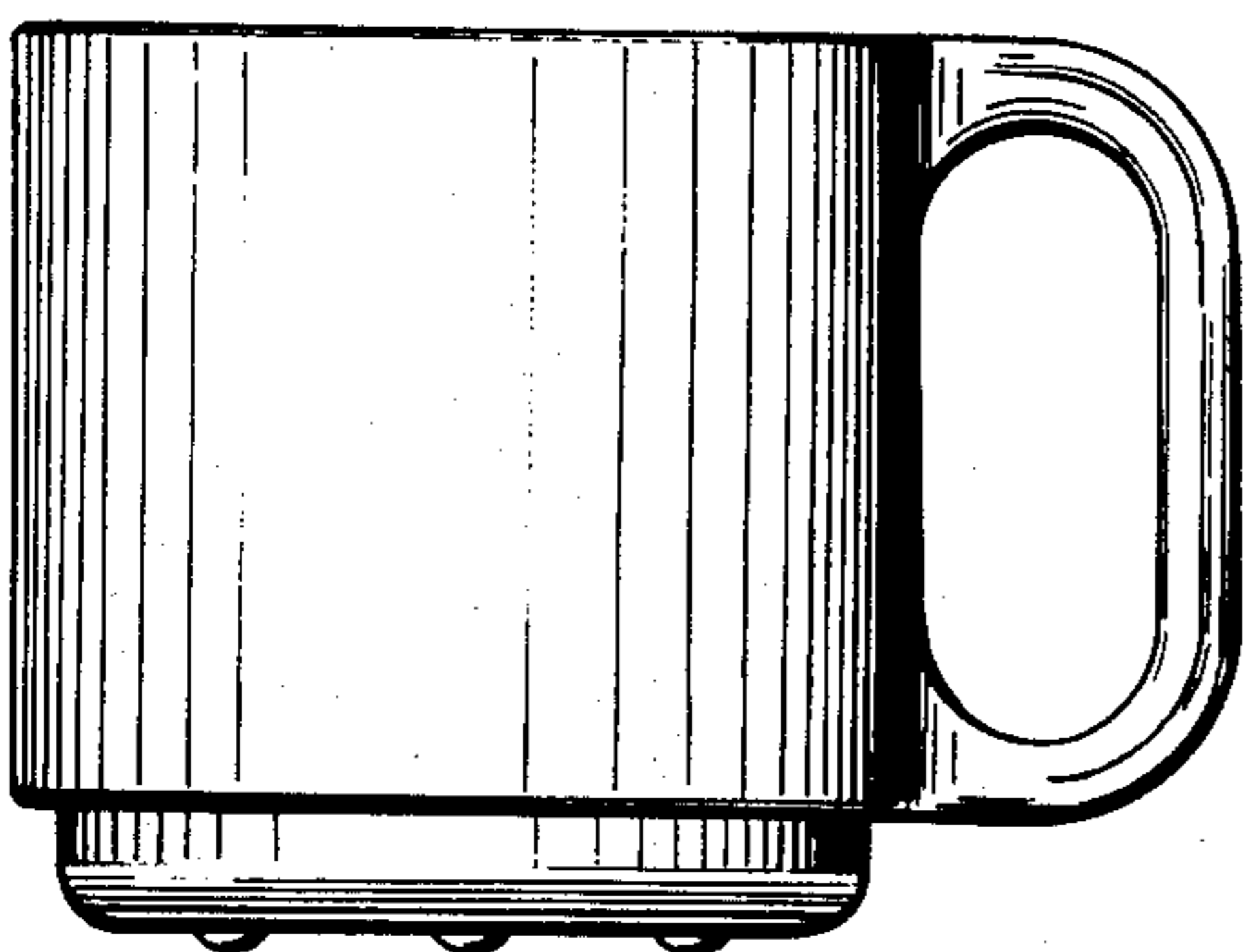

FIG. 3

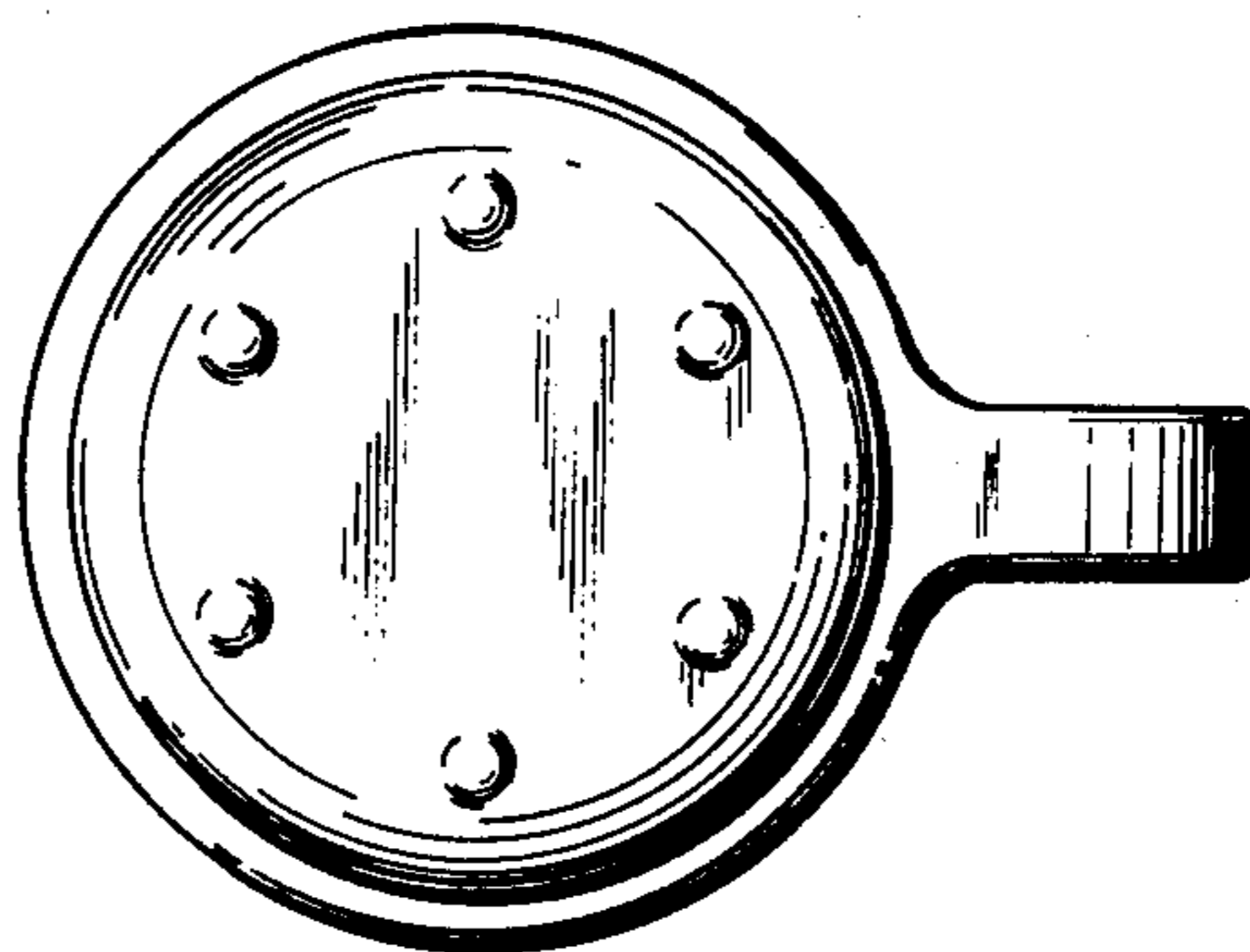

FIG. 5

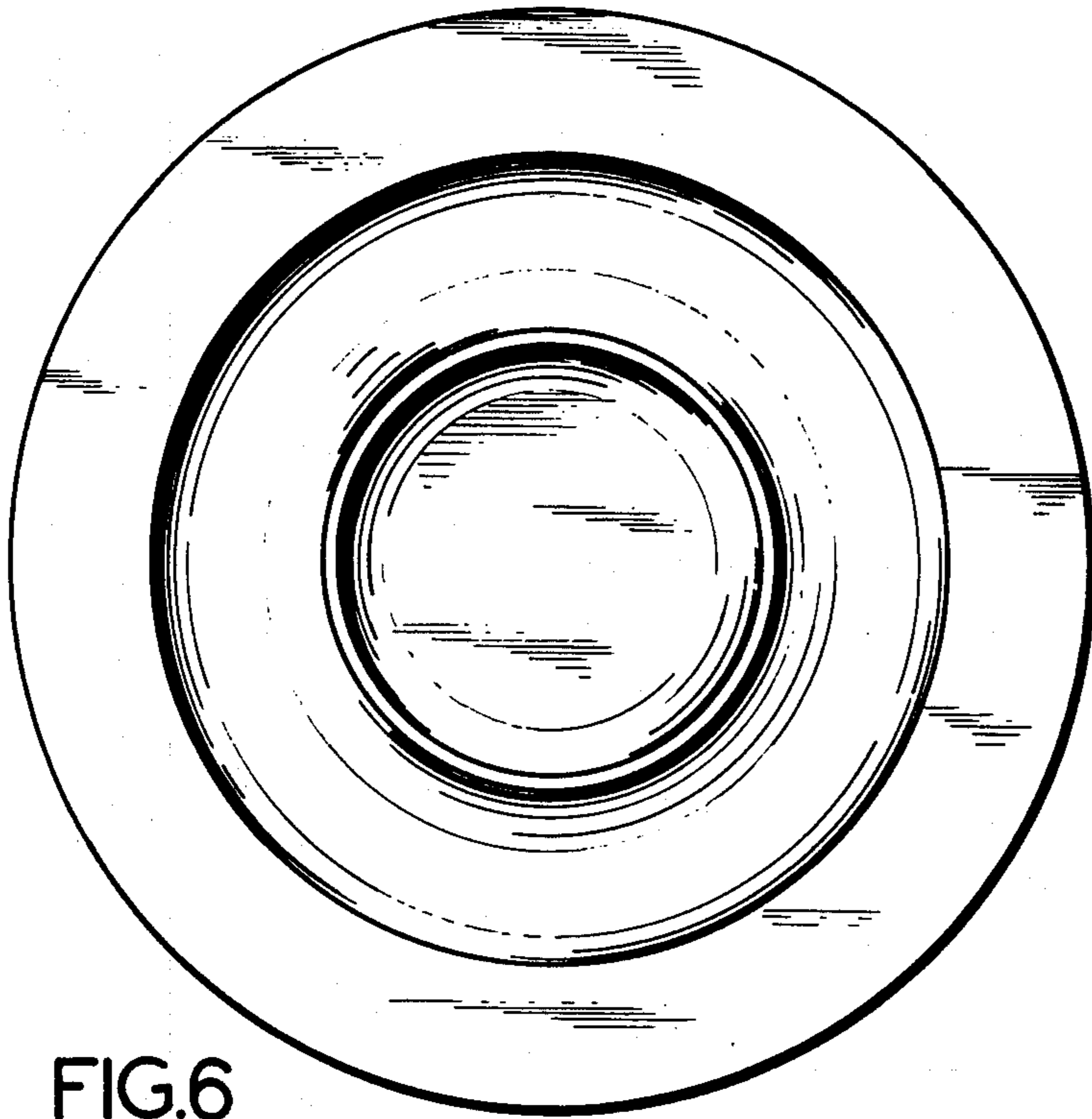

FIG. 6

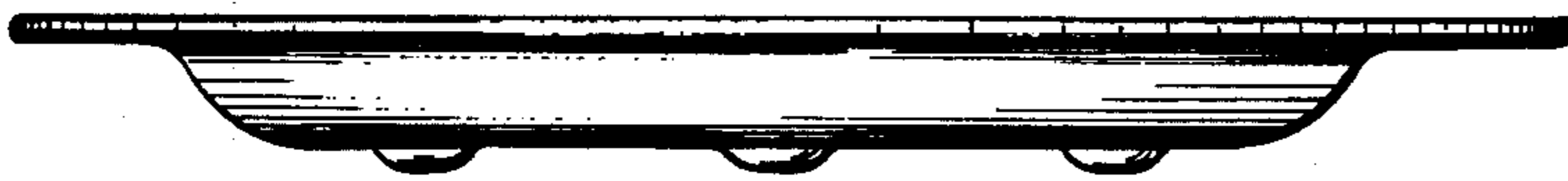

FIG. 7

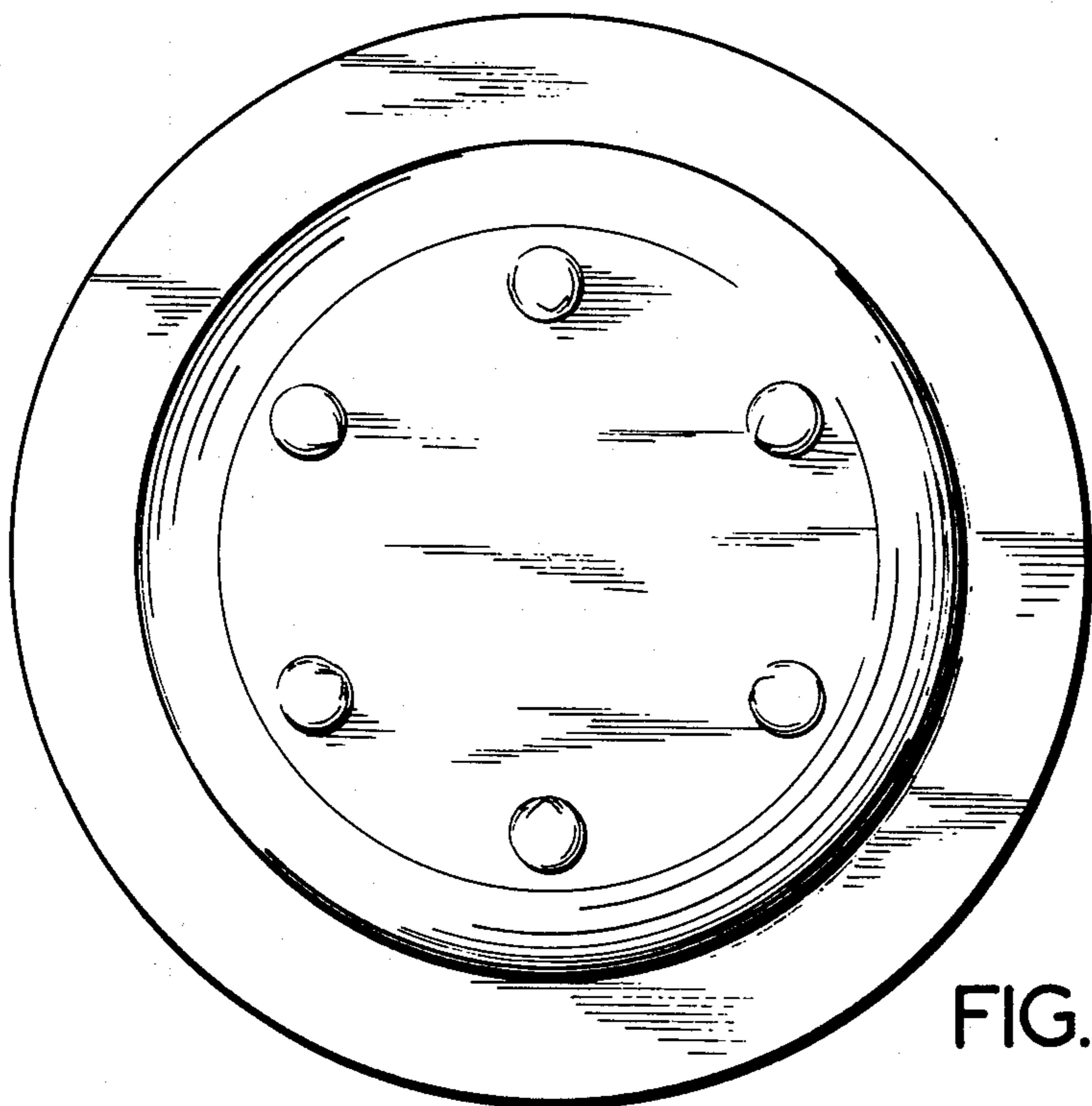

FIG. 8