

[54] SUPPORT STAND FOR A PORTABLE CALCULATOR

[76] Inventor: Jack Allen Turner, R.R. No. 2, Box 111, Centerville, Ind. 47330

[**] Term: 14 Years

[21] Appl. No.: 632,449

[22] Filed: Nov. 17, 1975

[51] Int. Cl. D6-04

[52] U.S. Cl. D6/181

[58] Field of Search D6/85, 181; D19/92, D19/86, 75; D9/242, 222, 243, 230, 221, 244, 246, 171; D87/1 B

[56] References Cited

U.S. PATENT DOCUMENTS

1,501,016	7/1924	Young	D9/230 X
1,932,429	10/1933	Wellman	D9/222 X
2,444,366	8/1948	Epps	D9/230 X
D. 76,793	11/1928	Gordon	D19/92
D. 206,468	12/1966	Neustadter et al.	D19/92 X
D. 218,542	8/1970	Neilsen	D19/92 X

Primary Examiner—Bruce W. Dunkins
Attorney, Agent, or Firm—Thomas P. Jenkins

[57] CLAIM

The ornamental design for a support stand for a portable calculator, as shown and described.

DESCRIPTION

FIG. 1 is a perspective view of an embodiment of the support stand for a portable calculator showing my new design;

FIG. 2 is a front elevational view of the stand of FIG. 1;

FIG. 3 is a back elevational view of the stand of FIG. 1;

FIG. 4 is a side elevational view of the stand of FIG. 1, the side opposite the side shown in FIG. 4 being a mirror image thereof;

FIG. 5 is a top plan view of the stand of FIG. 1;

FIG. 6 is a bottom plan view of the stand of FIG. 1;

FIG. 7 is a perspective view of another embodiment of the support stand for a portable calculator according to my new design;

FIG. 8 is a front elevational view of the stand of FIG. 7;

FIG. 9 is a side elevational view of the stand of FIG. 7, the side opposite the side shown in FIG. 9 being the mirror image thereof;

FIG. 10 is a back elevational view of the stand of FIG. 7;

FIG. 11 is a top plan view of the stand of FIG. 7; and
FIG. 12 is a bottom plan view of the stand of FIG. 7.

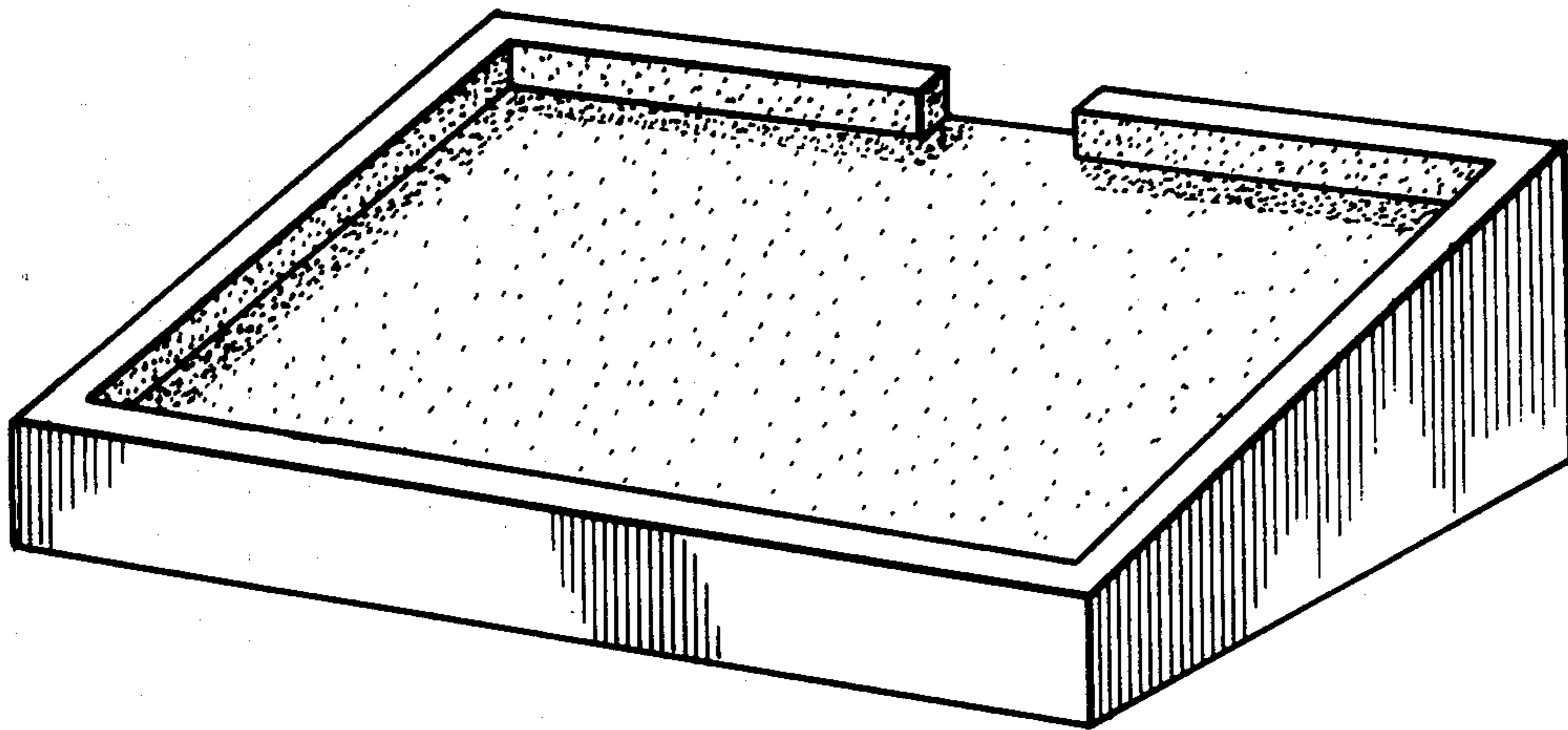

Fig. 1

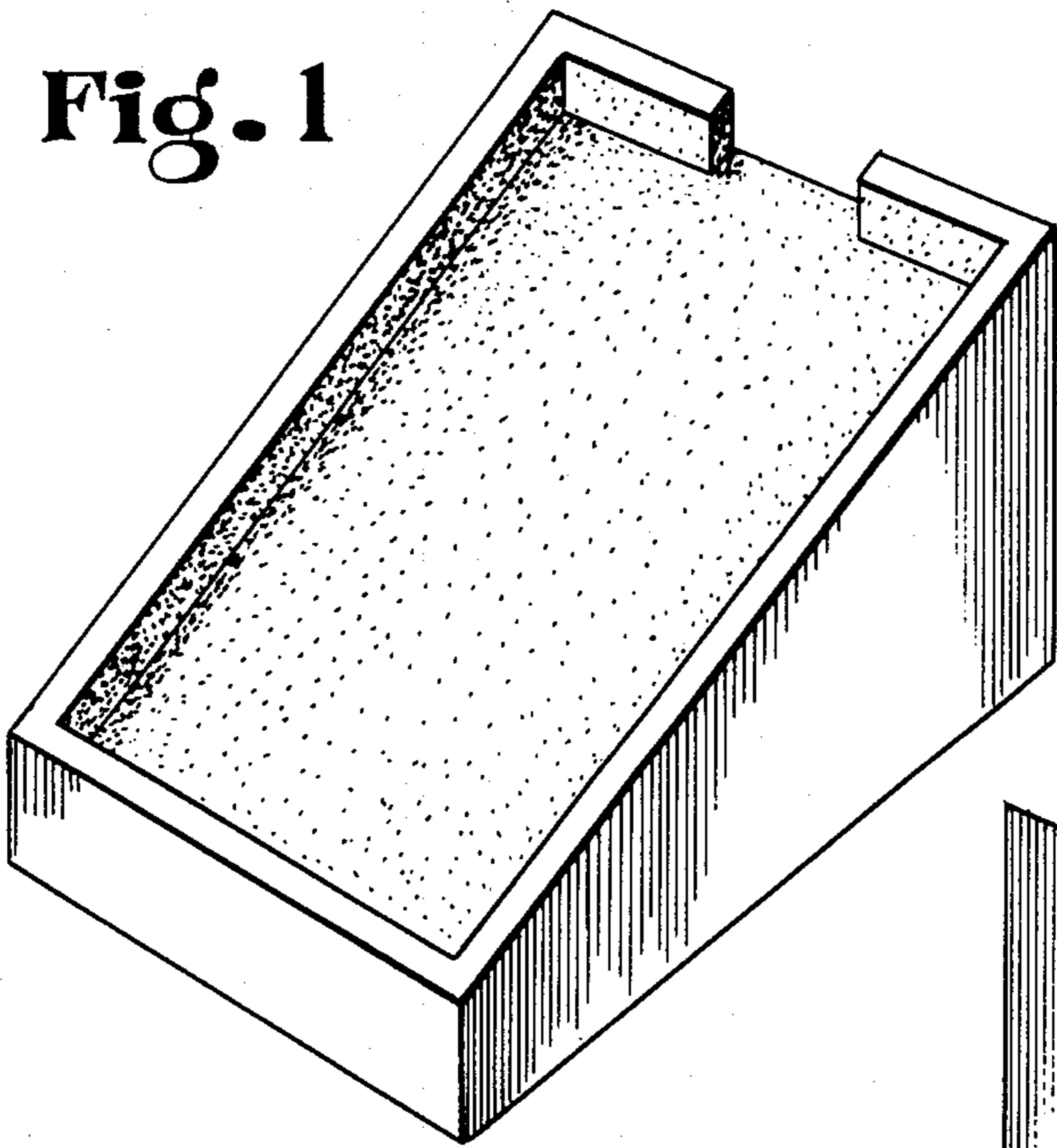

Fig. 4

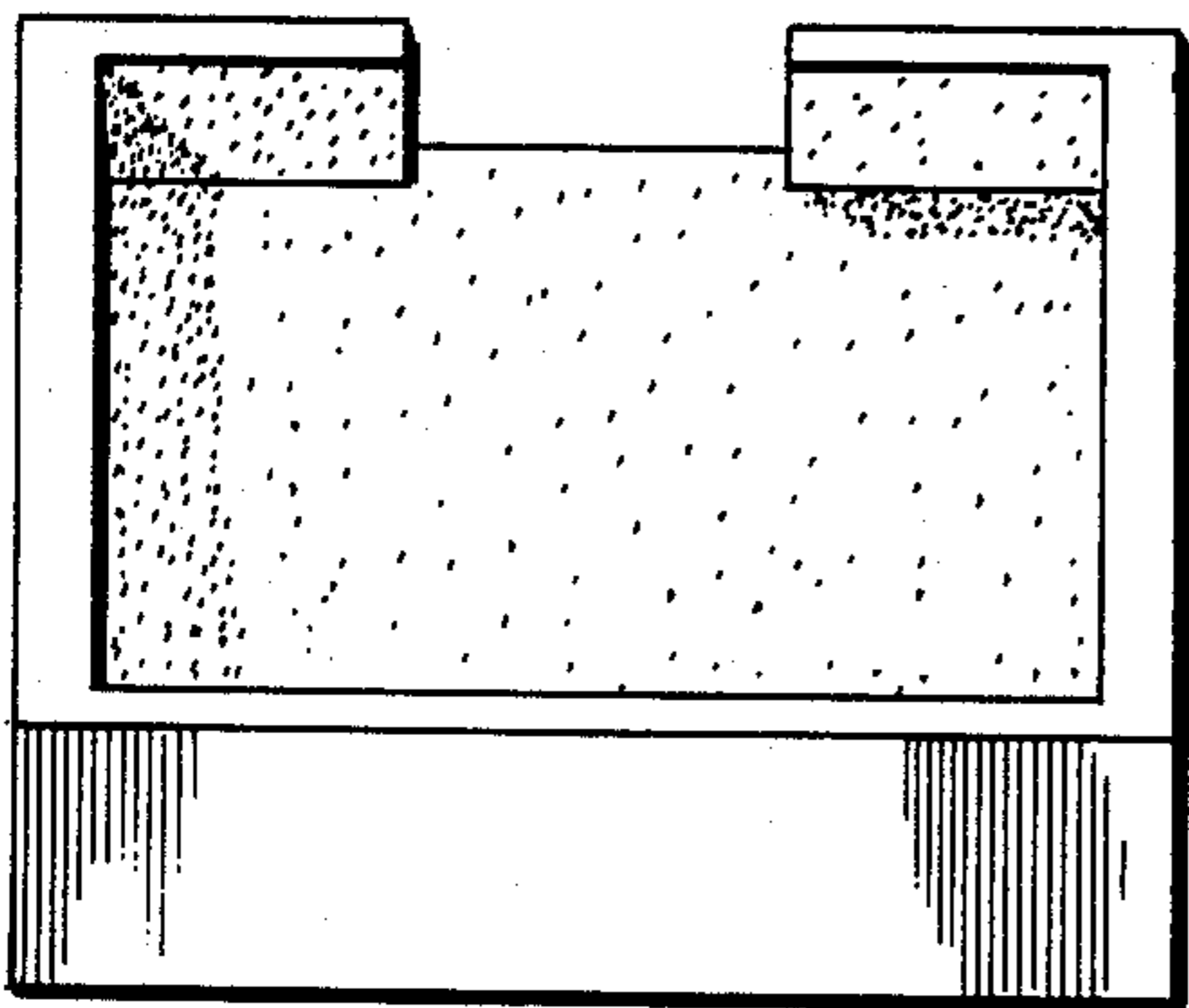
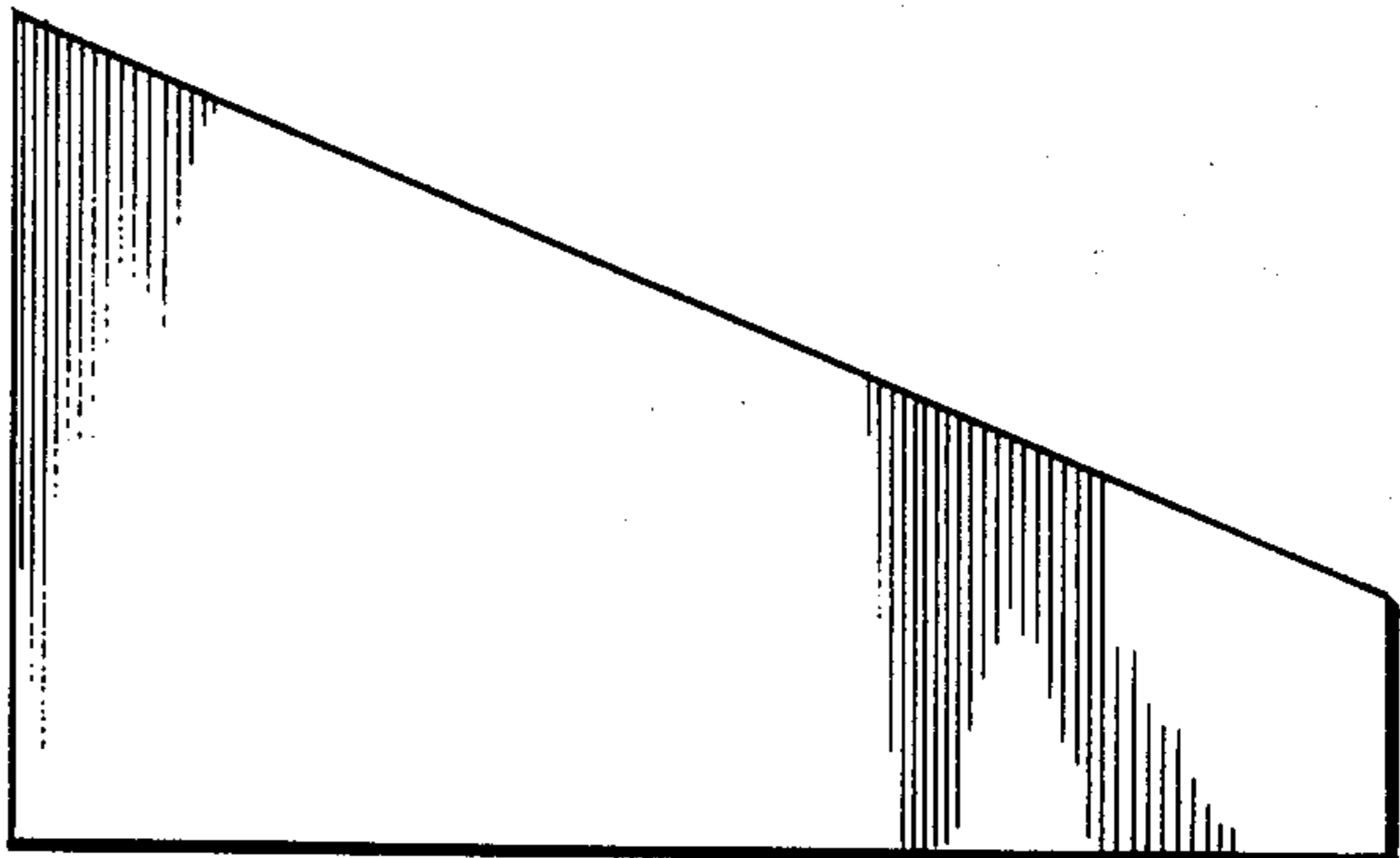

Fig. 2

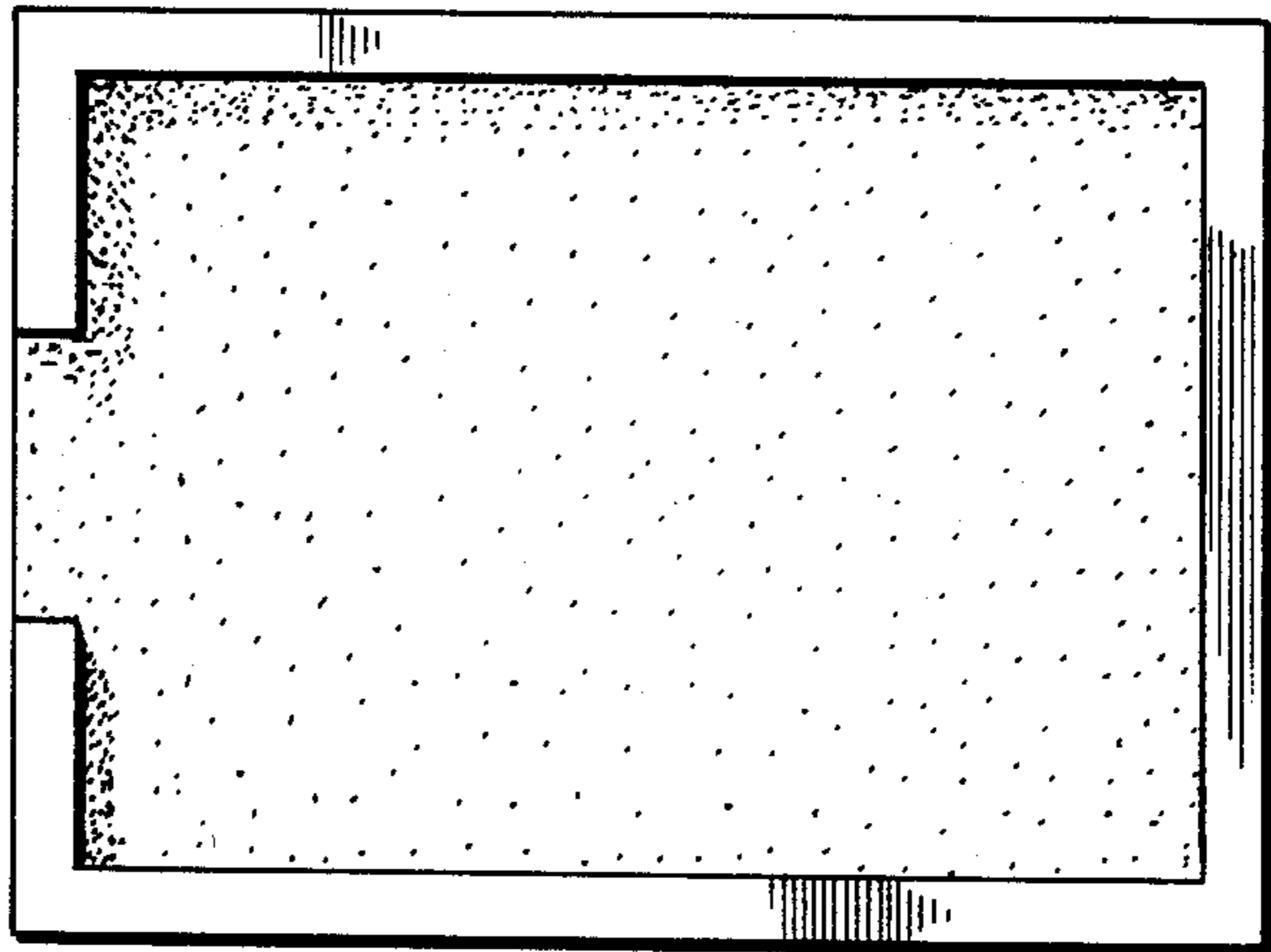

Fig. 5

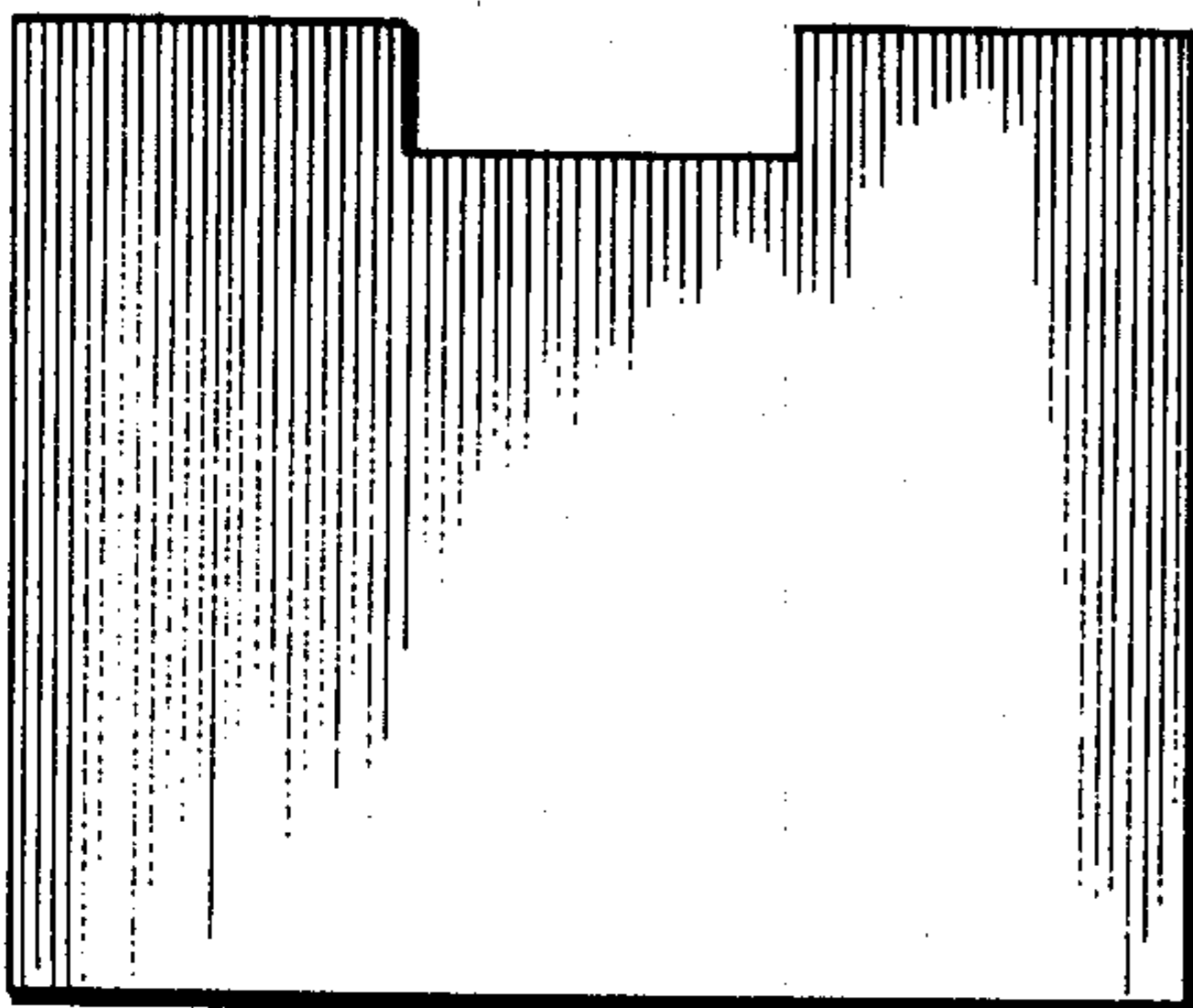

Fig. 3

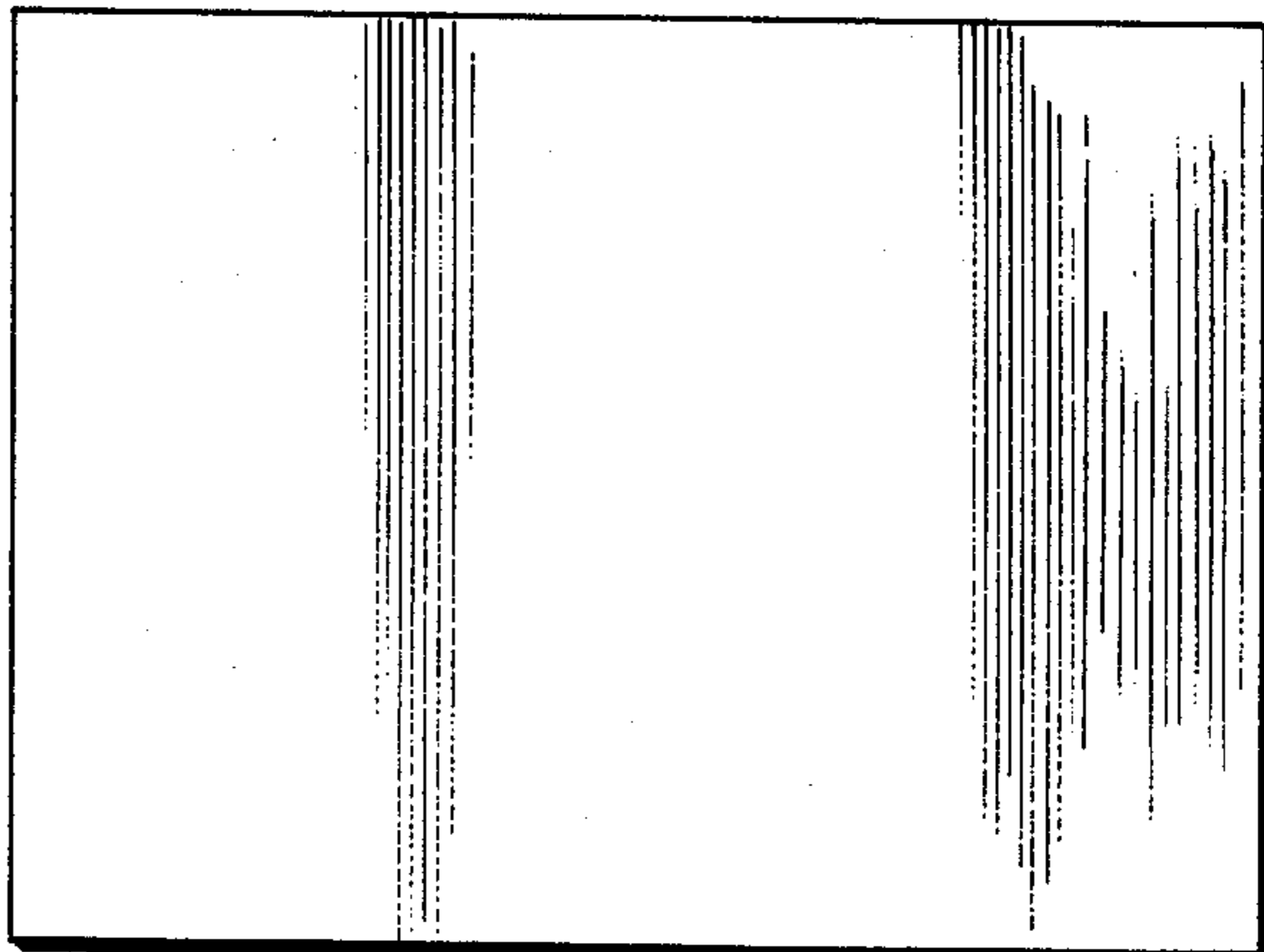

Fig. 6

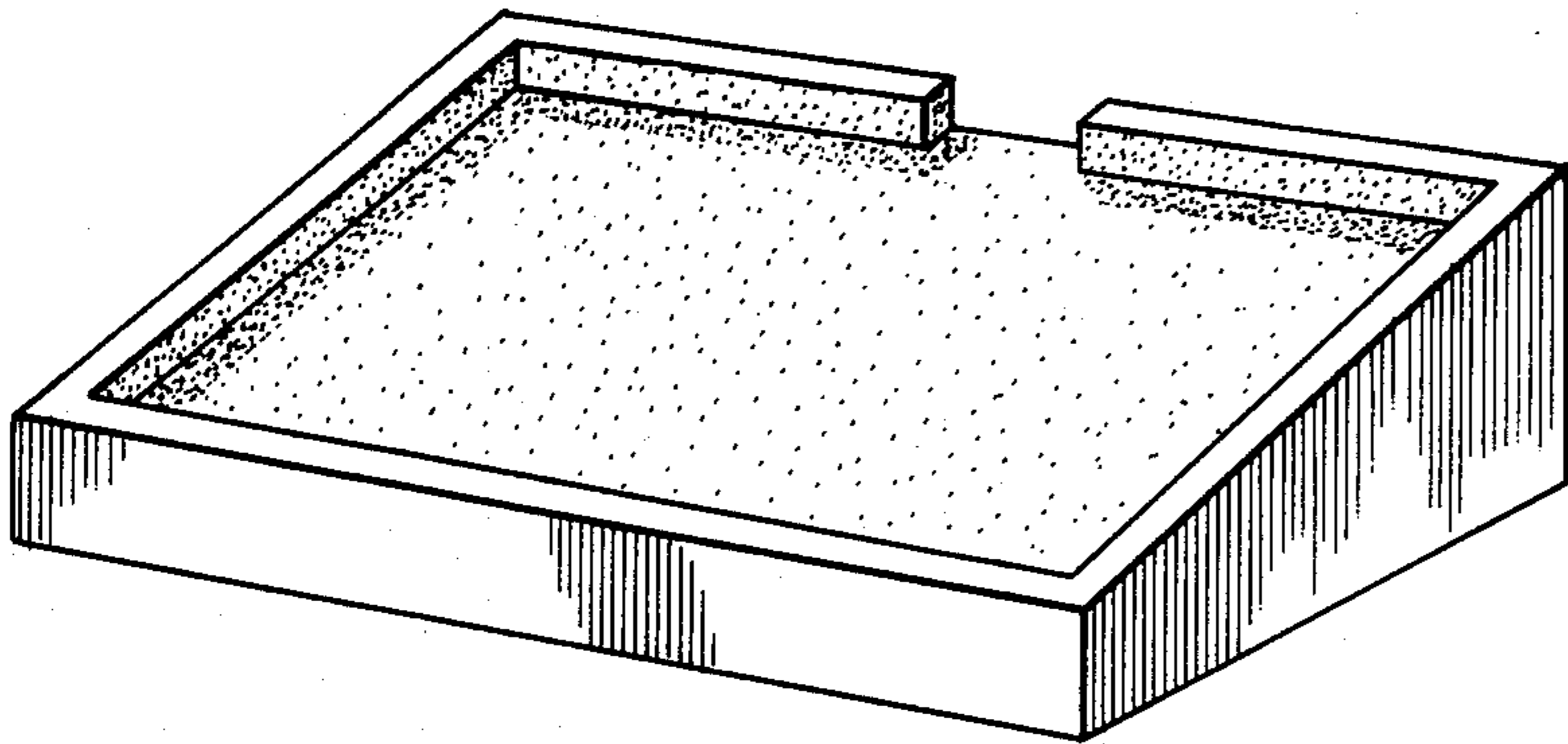

Fig. 7

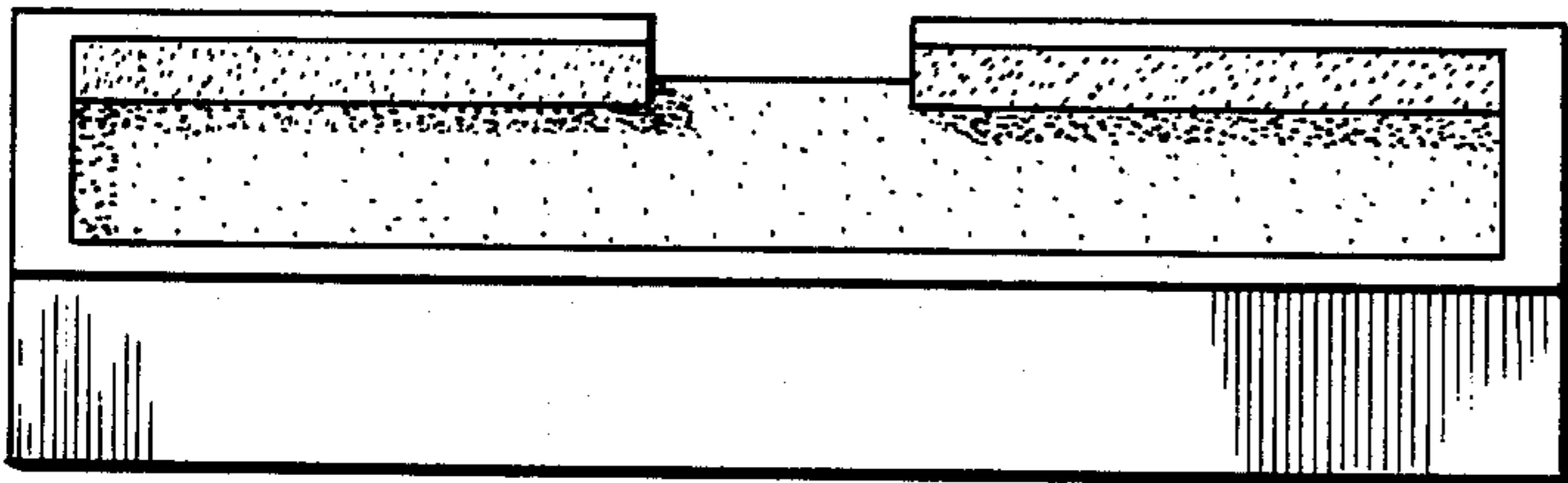

Fig. 8

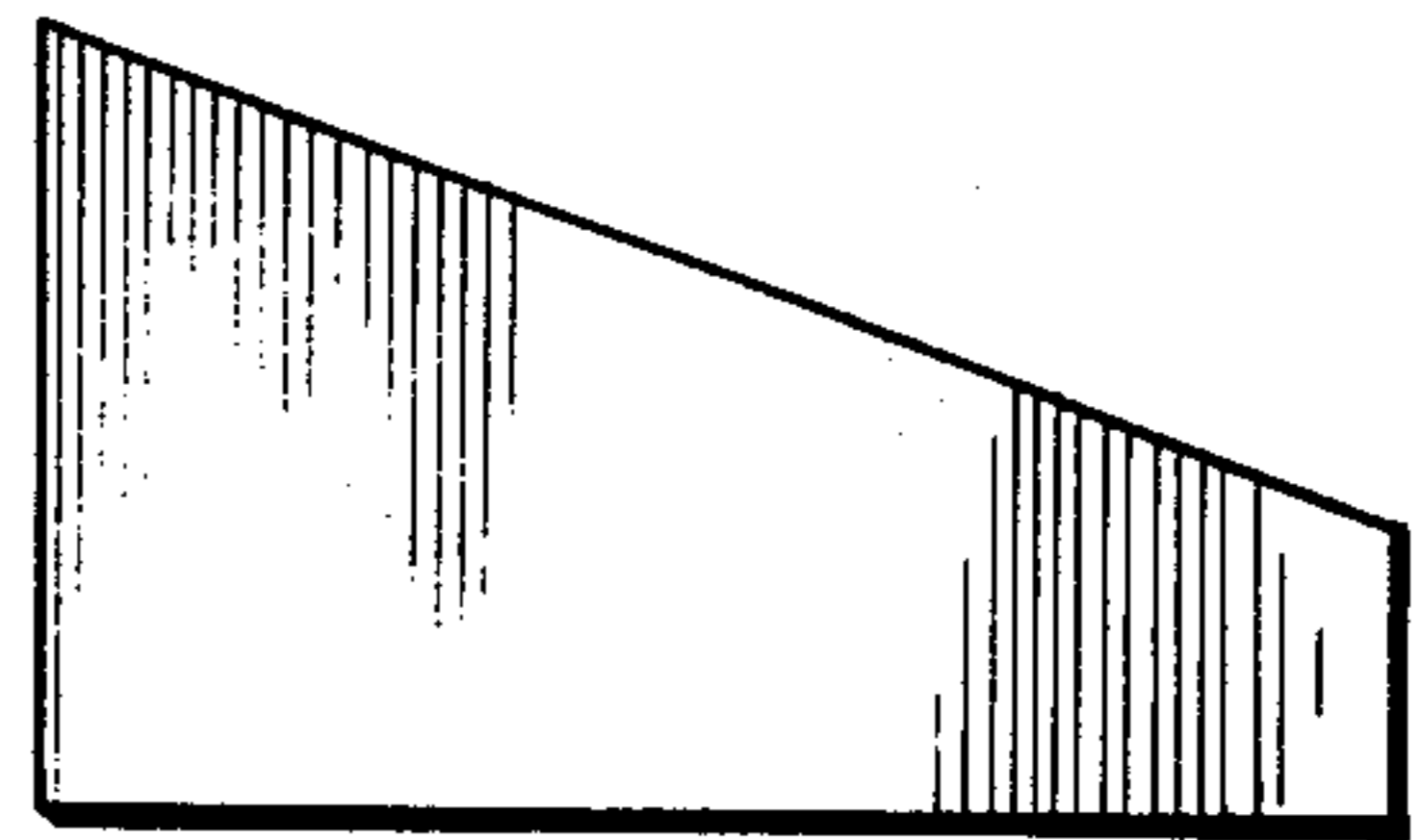

Fig. 9

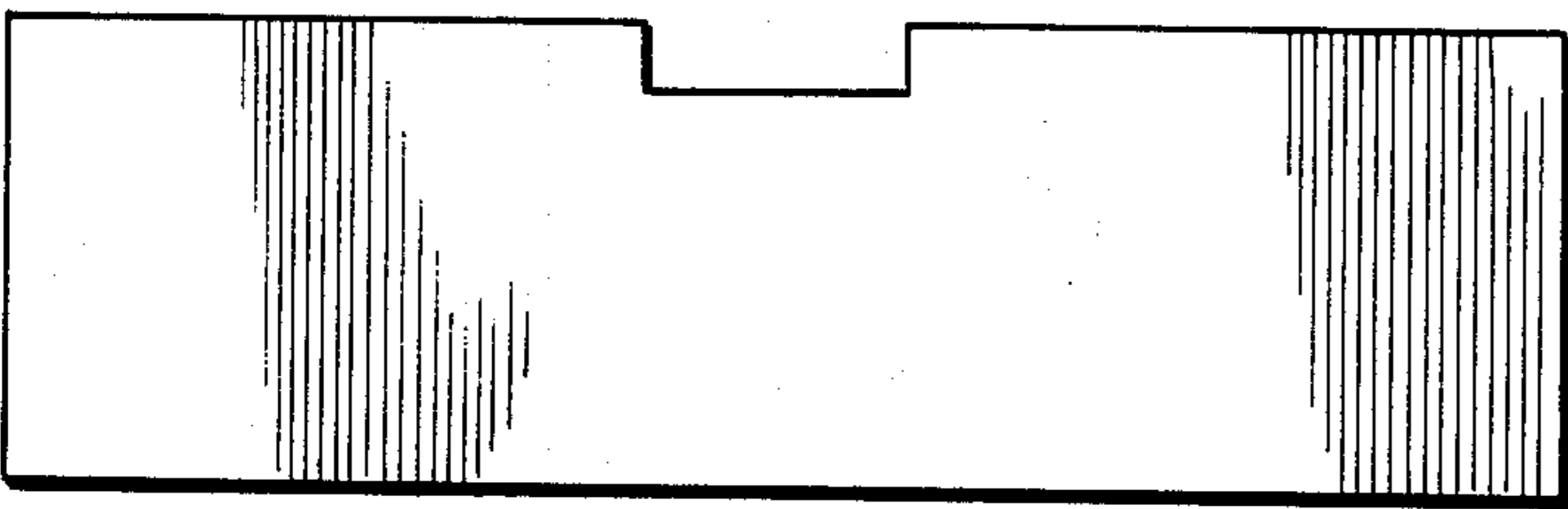

Fig. 10

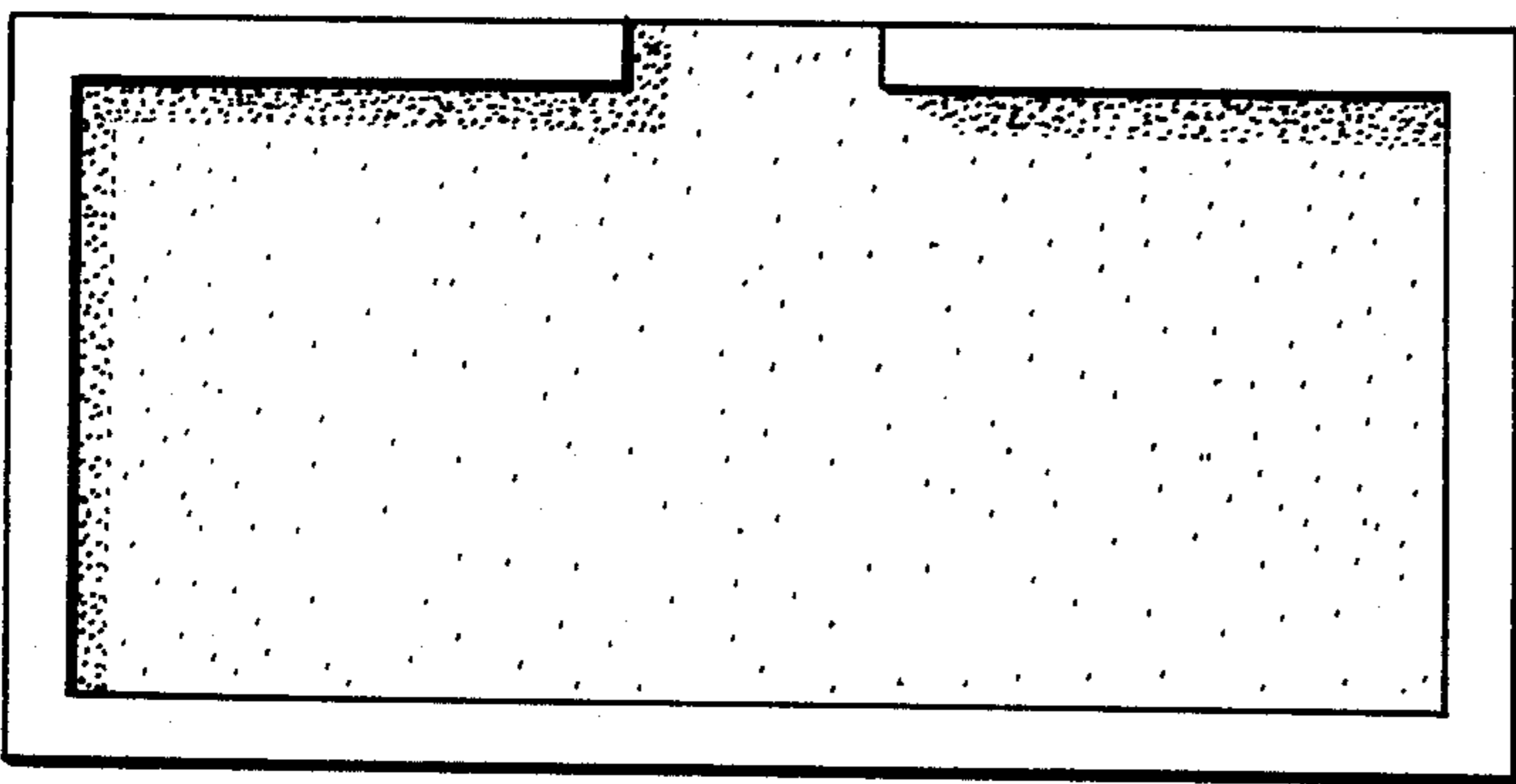

Fig. 11

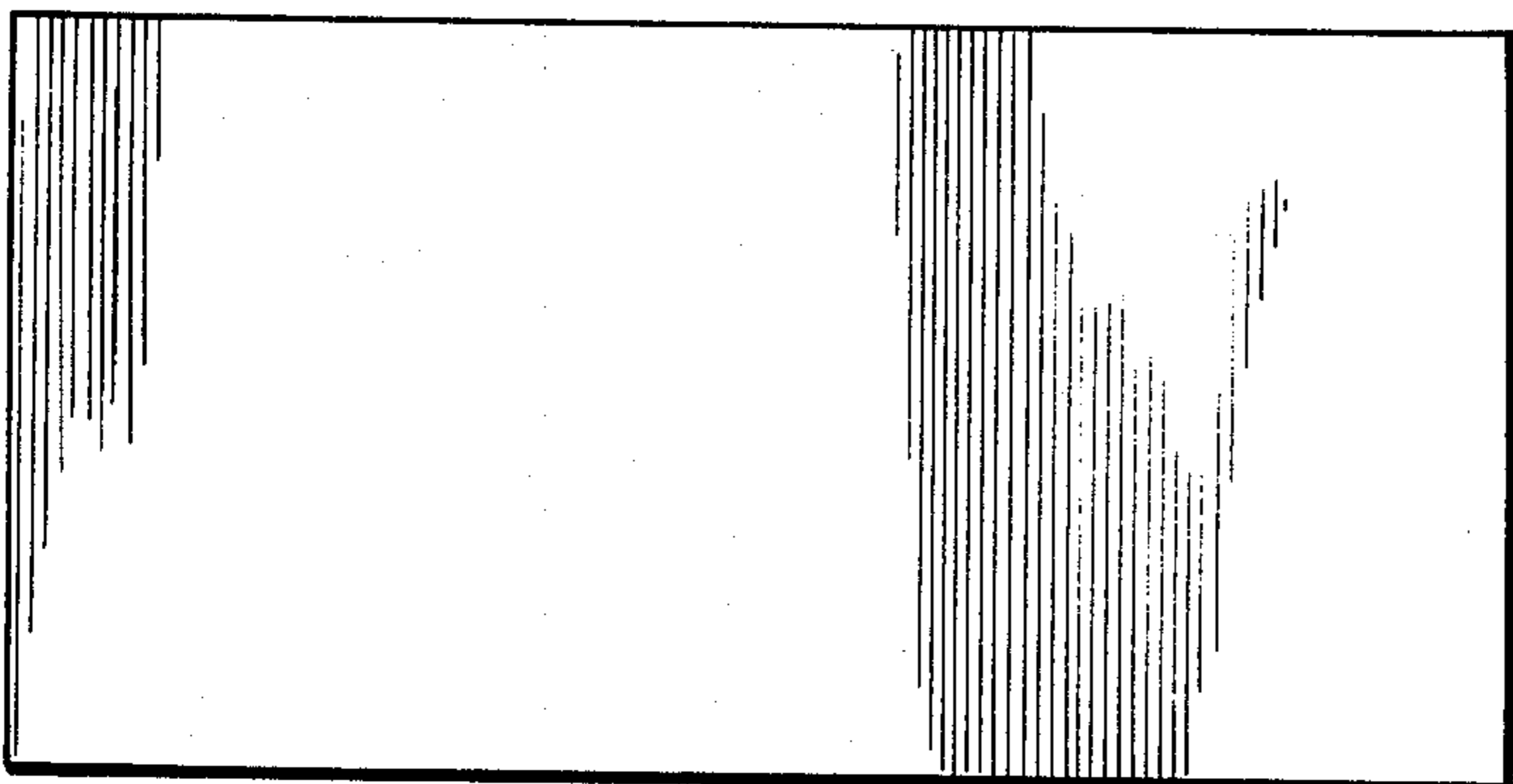

Fig. 12