

[54] COMBINED SHOWER AND LAVATORY MODULE FOR CAMPERS, MOTOR HOMES AND THE LIKE

[76] Inventor: Sheldon Baer, 2970 Dona Emilia Drive, Studio City, Calif. 91604

[**] Term: 14 Years

[21] Appl. No.: 643,160

[22] Filed: Dec. 22, 1975

[51] Int. Cl. D23-02

[52] U.S. Cl. D23/49

[58] Field of Search D23/48-50, D23/55-57; 4/1-5, 10, 146, 148, 152-155, 173, 178, 180, 185 S, 185 AB, 185 L

[56] References Cited

U.S. PATENT DOCUMENTS

3,533,200	10/1970	Zoebelein	4/146
D. 186,209	9/1959	Everett	D23/49
D. 203,253	12/1965	Kanter	D23/49
D. 225,848	1/1973	Fulton et al.	D23/49
D. 227,569	7/1973	Callahan	D23/49
D. 228,066	8/1973	Humphries, Jr.	D23/49

OTHER PUBLICATIONS

Architectural Record, Feb. 1961, p. 200, "Pint-Size Prefab Bathroom".

Primary Examiner—James R. Largen
Attorney, Agent, or Firm—Don B. Finkelstein

[57] CLAIM

The ornamental design for a combined shower and lavatory module for campers, motor homes and the like, as shown.

DESCRIPTION

FIG. 1 is a front perspective view of a combined shower and lavatory module for campers, motor homes, and the like, showing my new design;

FIG. 2 is a right side perspective view thereof;

FIG. 3 is a left side perspective view thereof;

FIG. 4 is a rear perspective view thereof;

FIG. 5 is a top plan view thereof;

FIG. 6 is a bottom plan view thereof;

FIG. 7 is another front perspective view thereof;

FIG. 8 is a fragmentary perspective view showing the lavatory portion of the module;

FIG. 9 is a third front perspective view thereof;

FIG. 10 is a fragmentary perspective view showing the details of the soap holder portion of the module;

FIG. 11 is a fragmentary perspective view showing the details of the interior floor portion of the module;

FIG. 12 is a sectional view along the line 12-12 of FIG. 1.

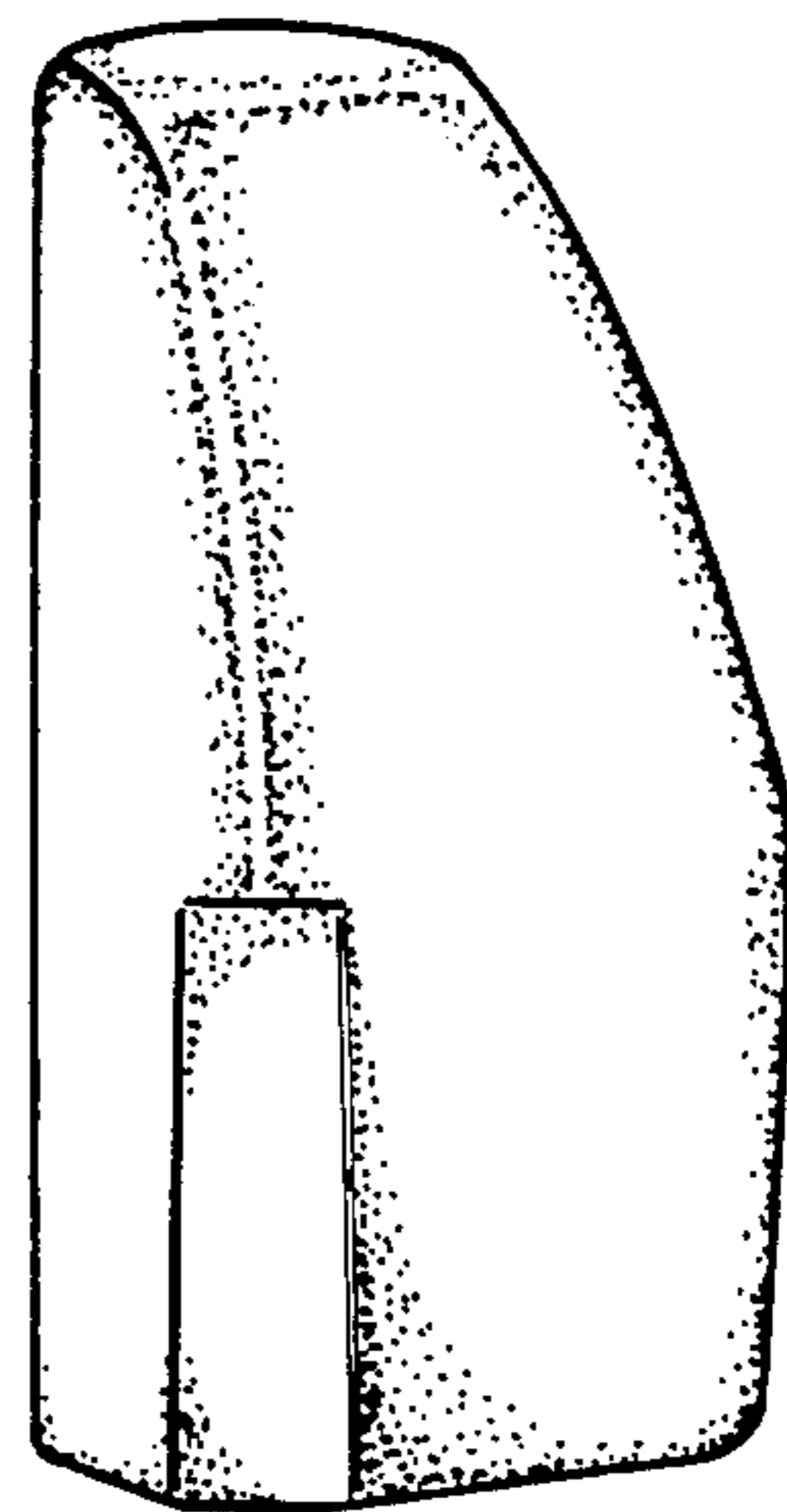
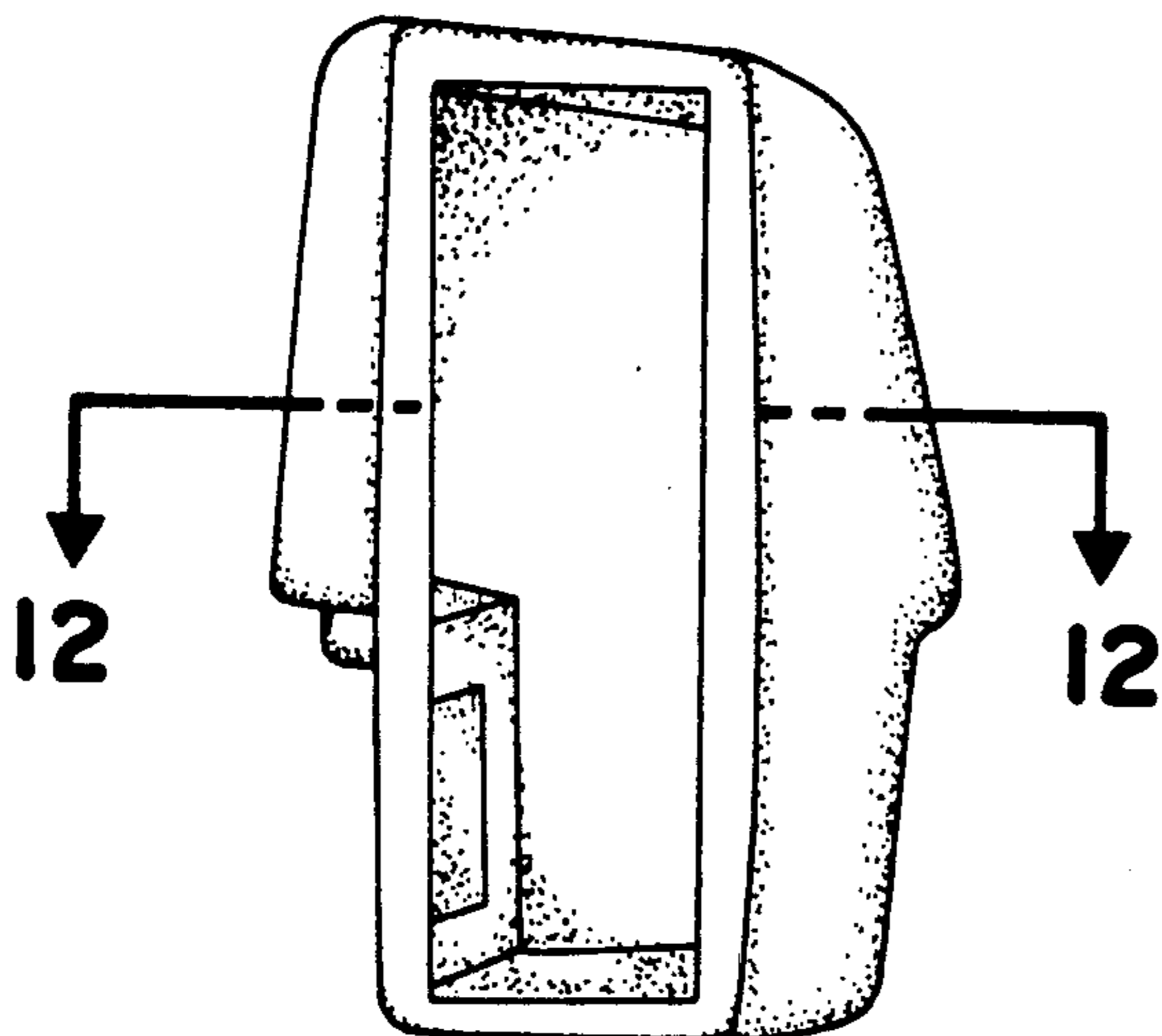

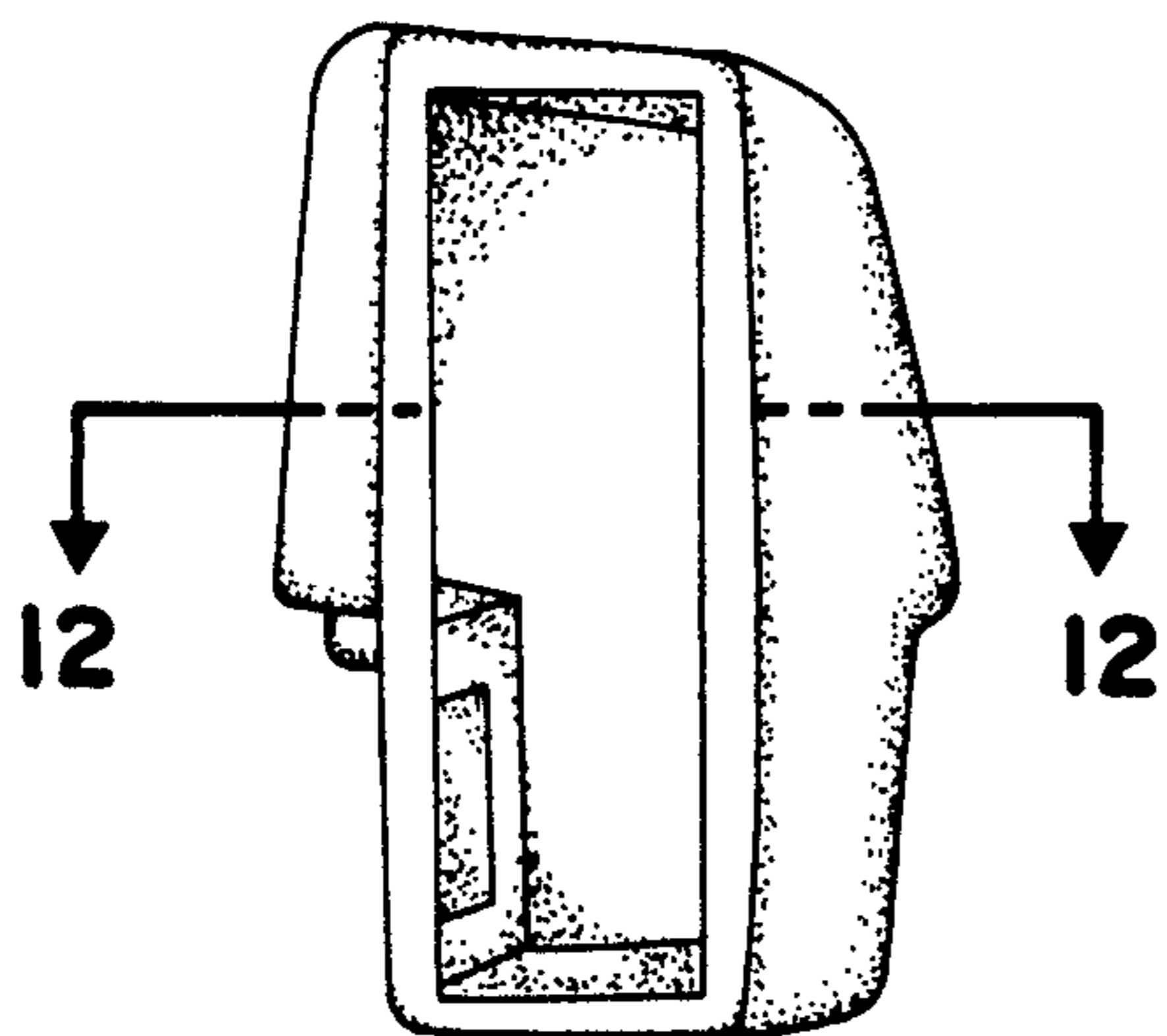

FIG. 1.

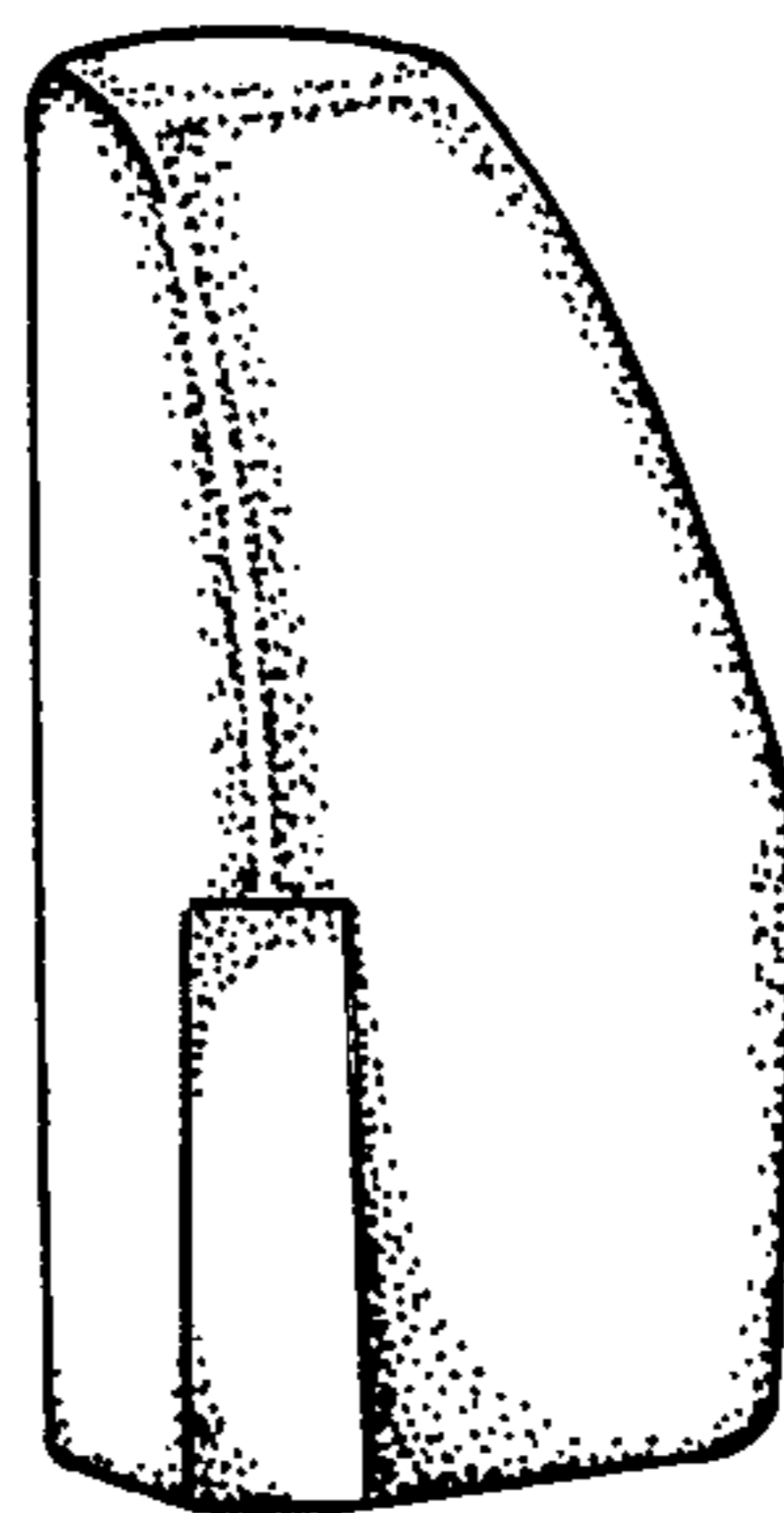

FIG. 2.

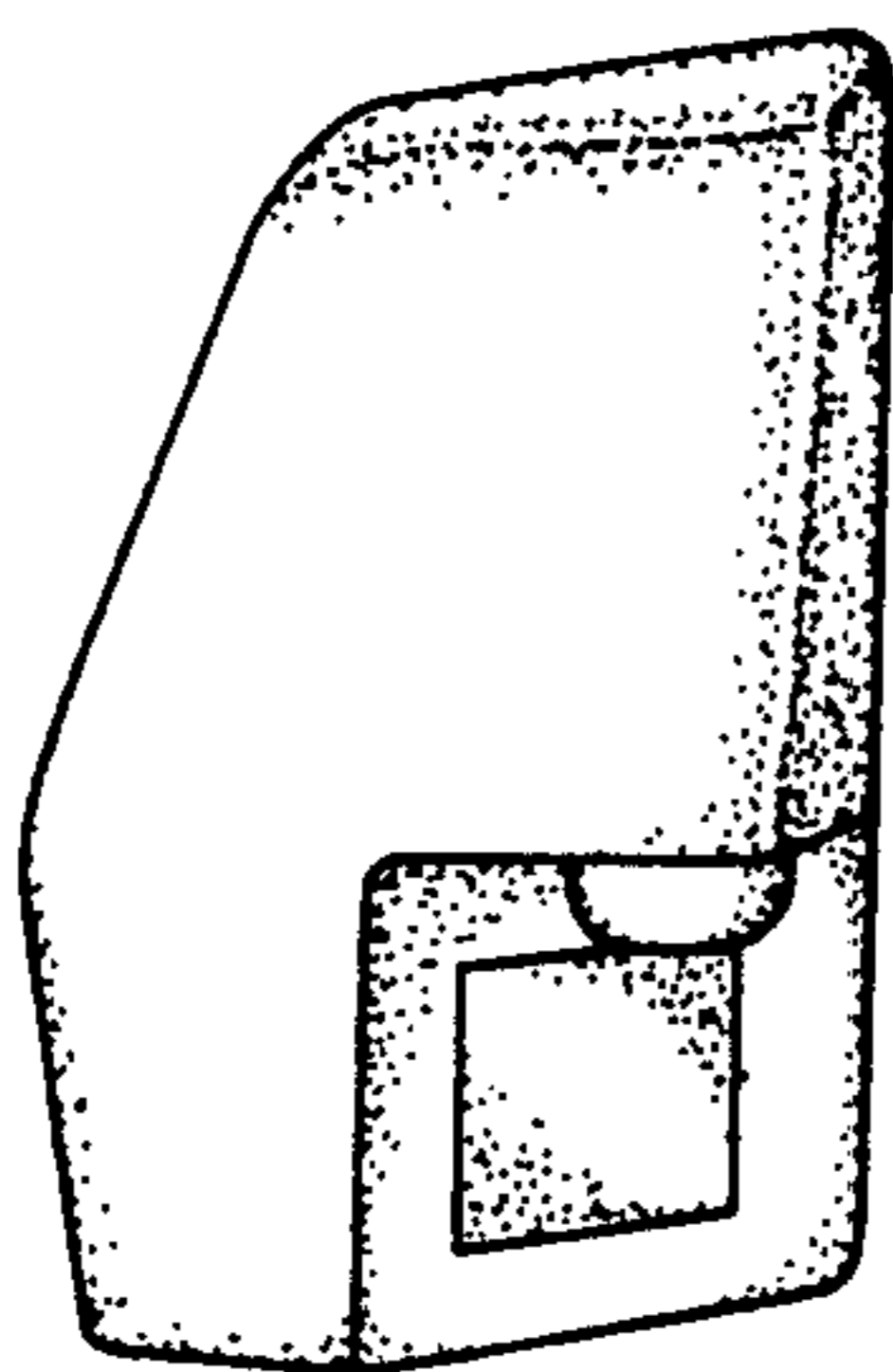

FIG. 3.

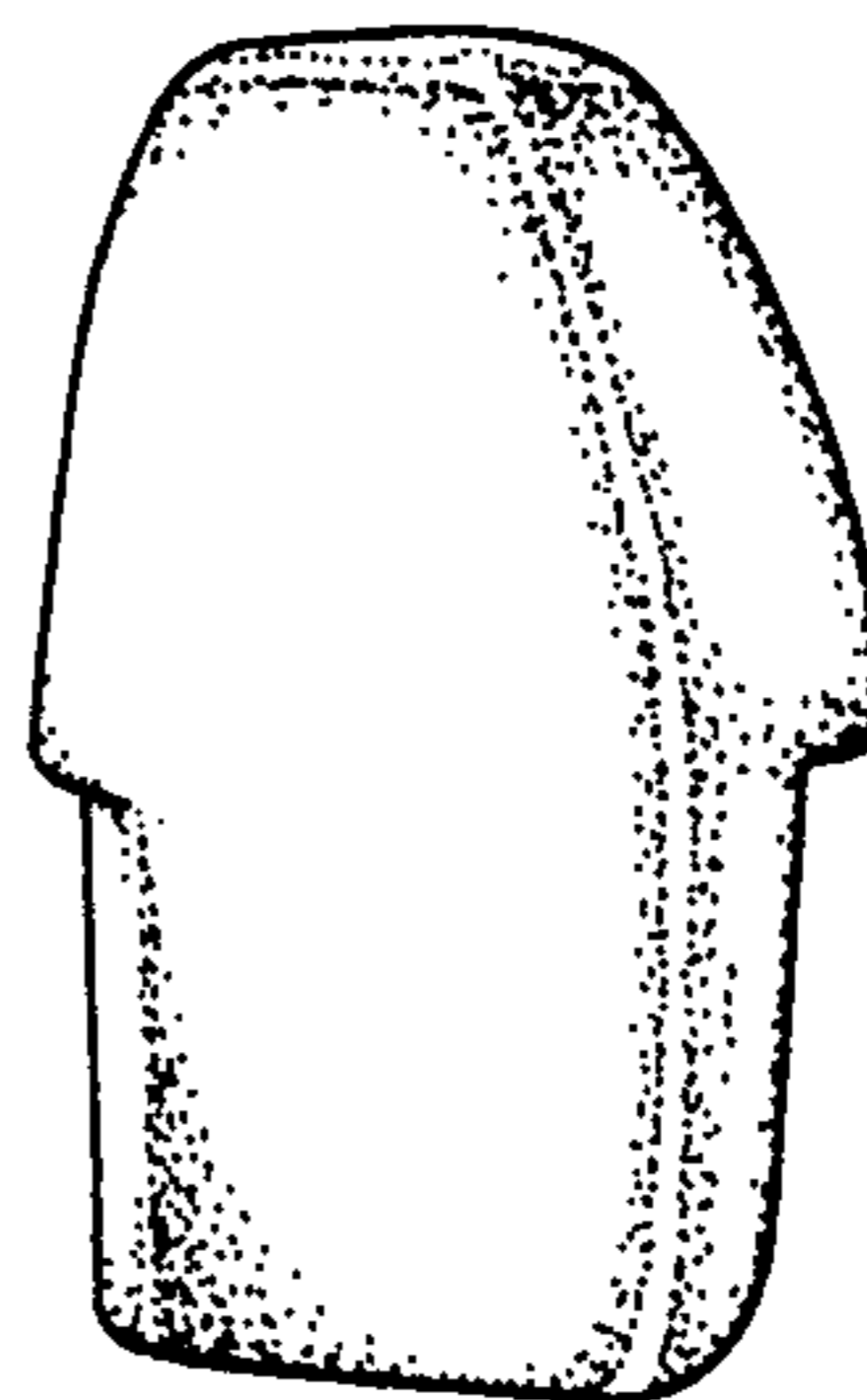

FIG. 4.

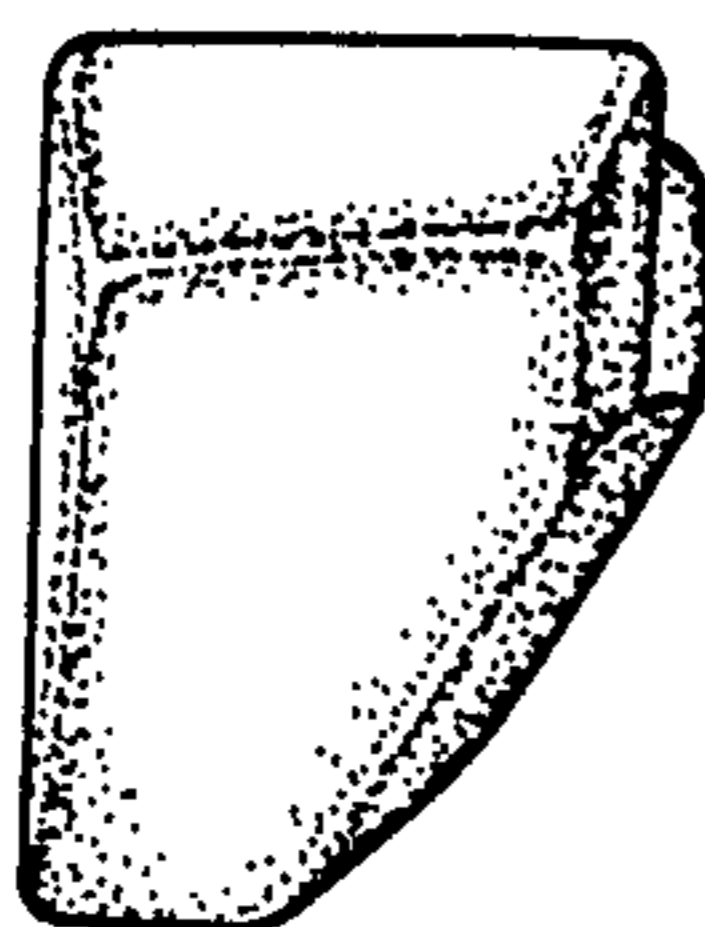

FIG. 5.

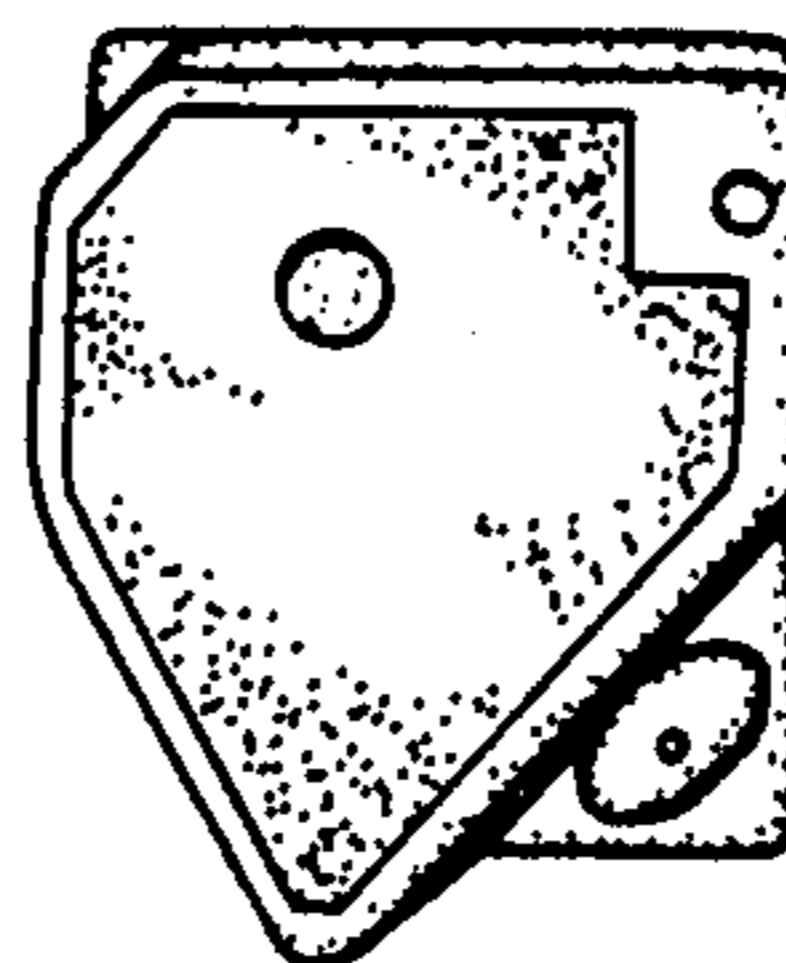

FIG. 6.

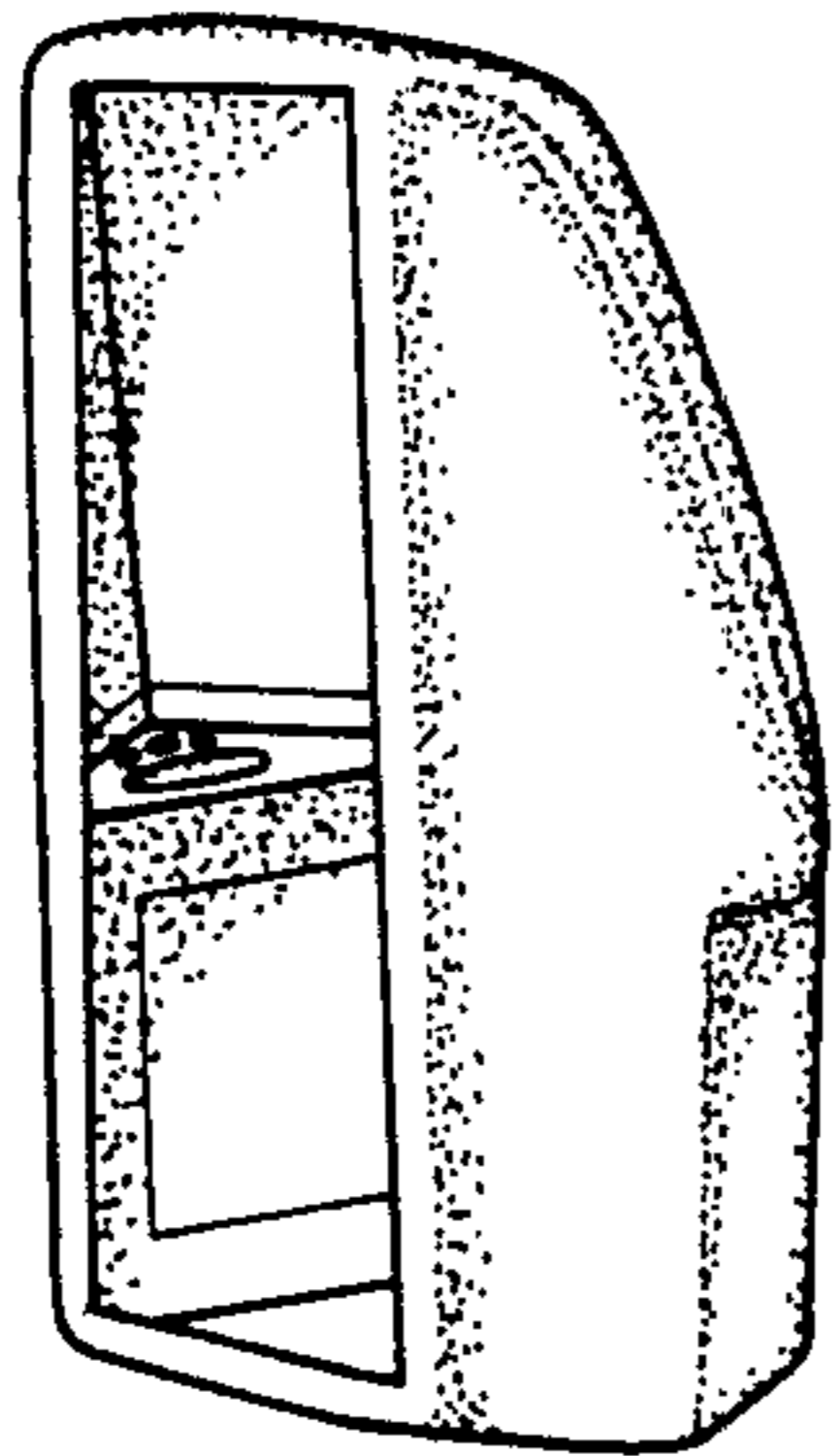

FIG. 7.

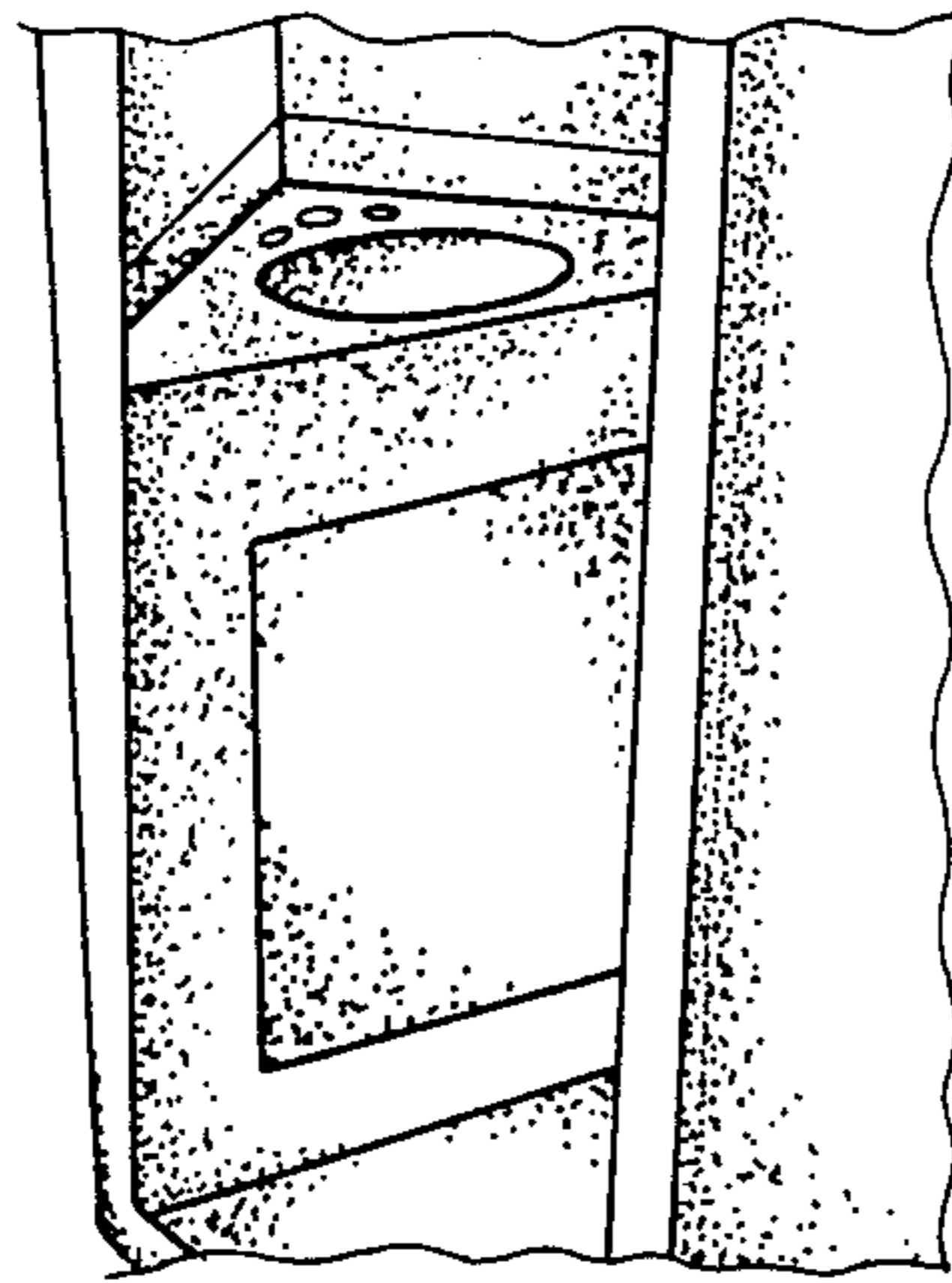

FIG. 8.

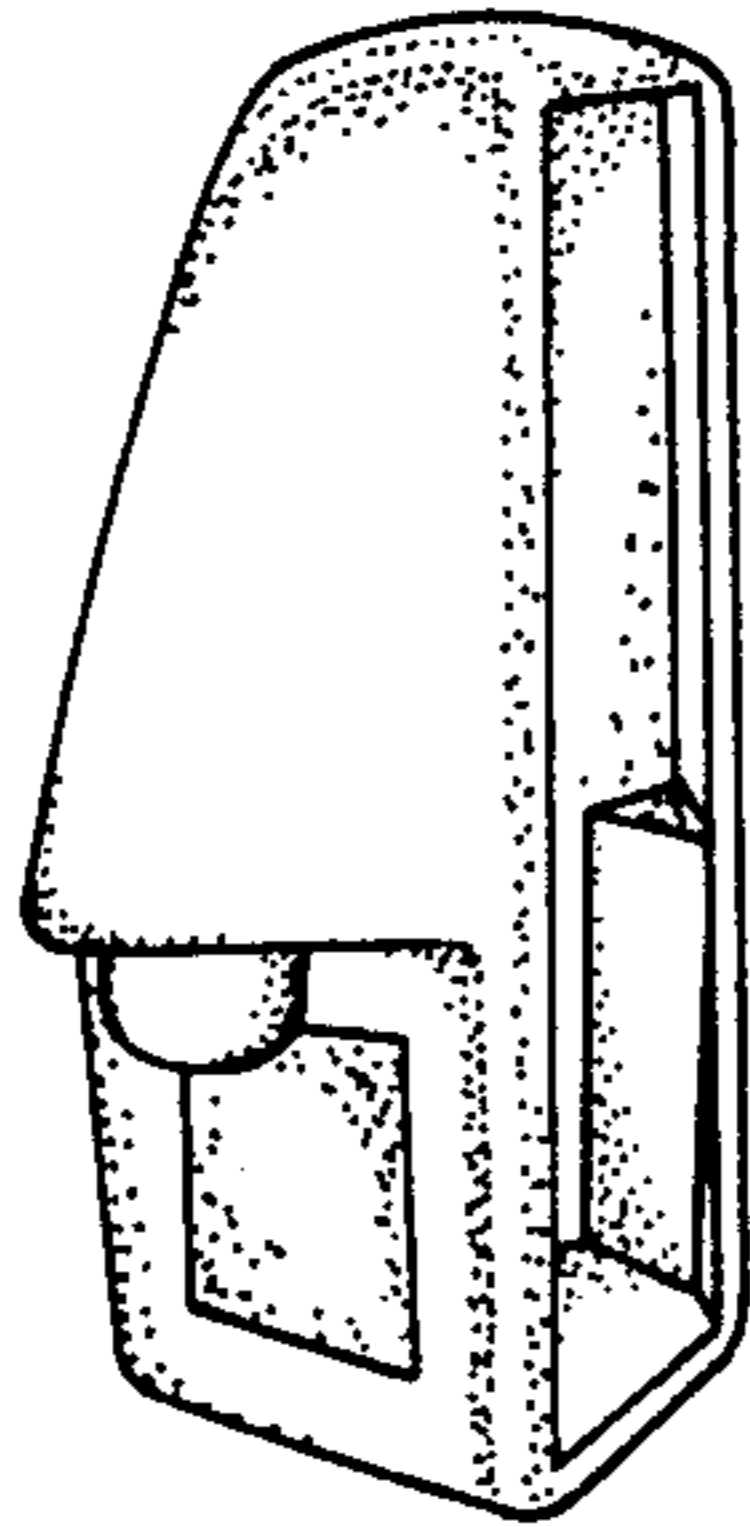

FIG. 9.

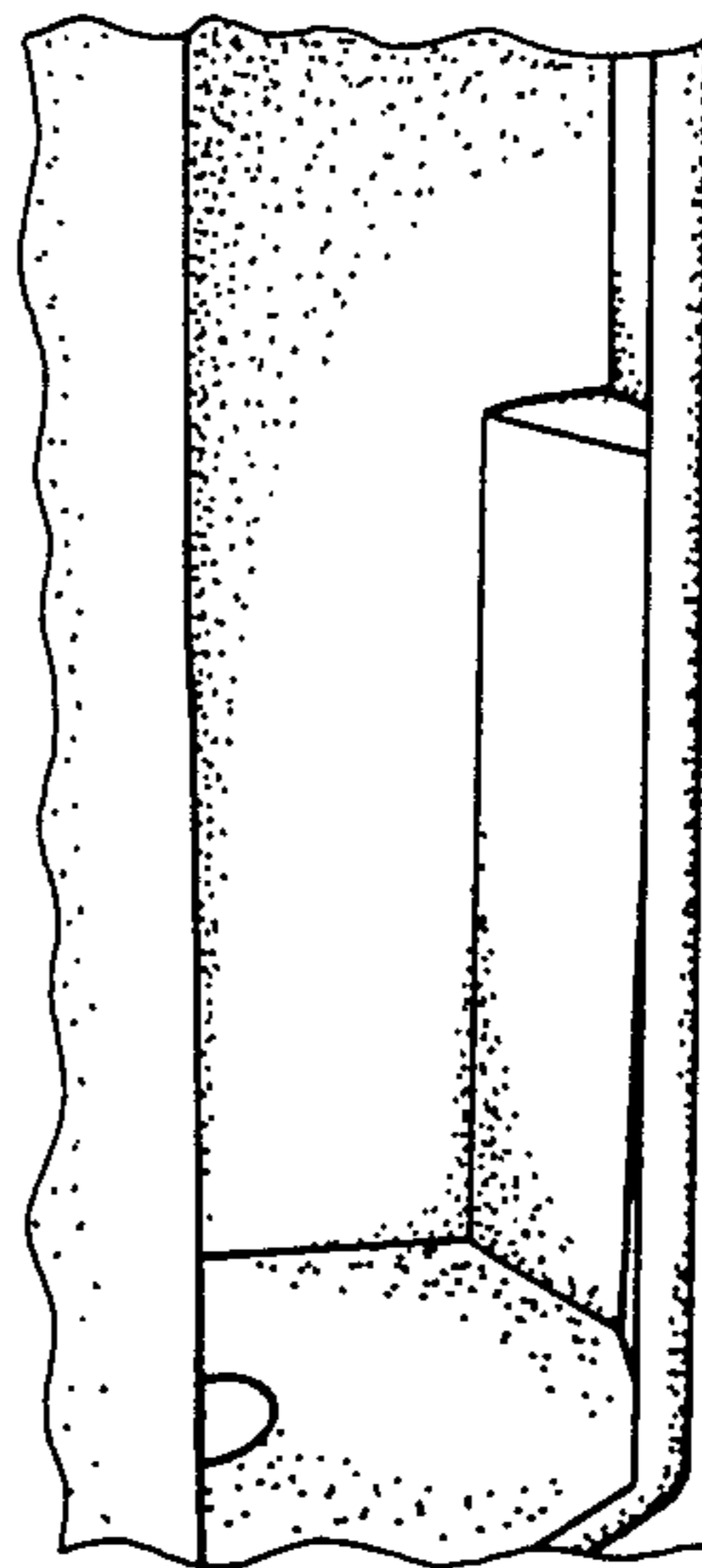

FIG. 10.

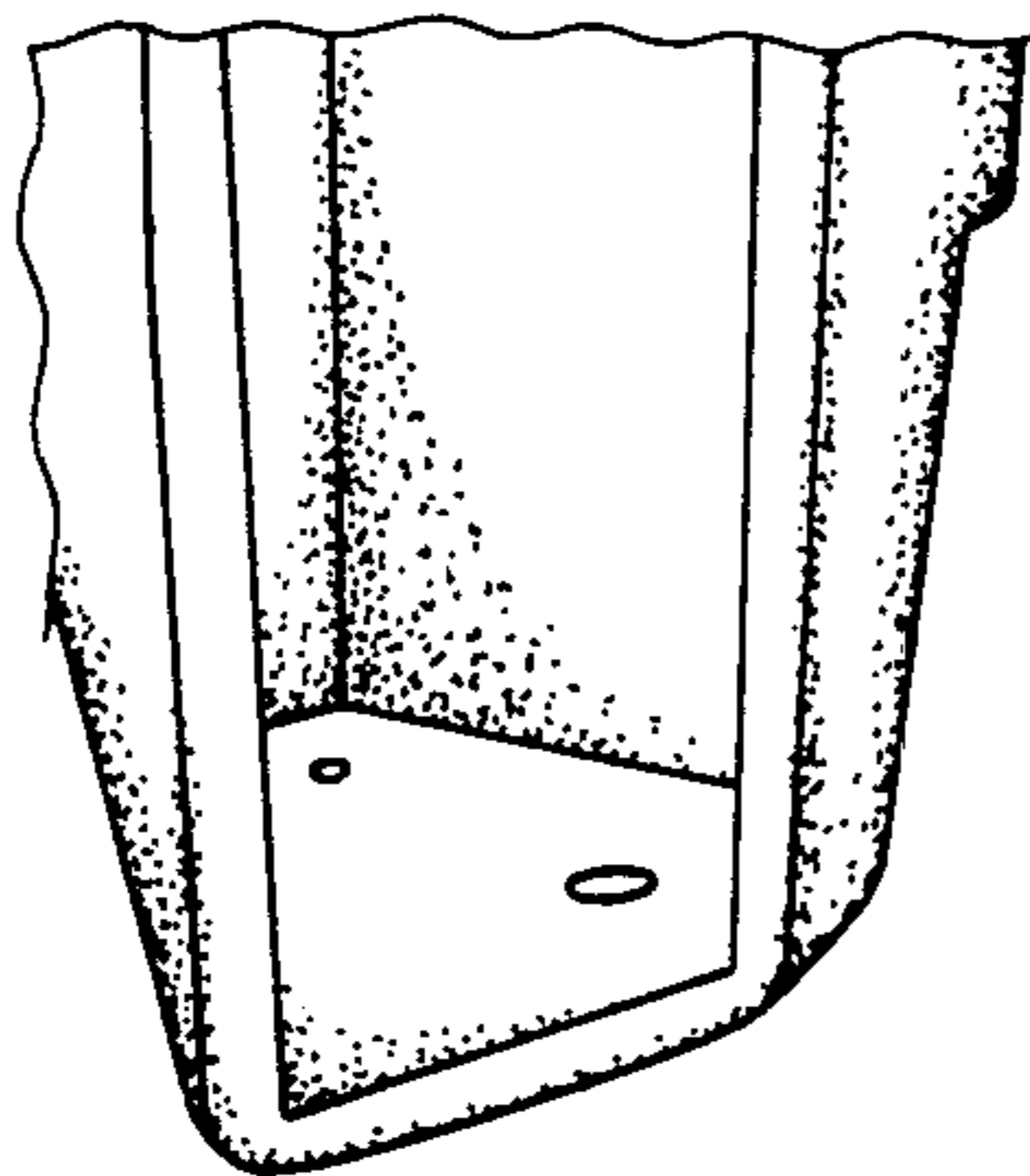

FIG. 11.

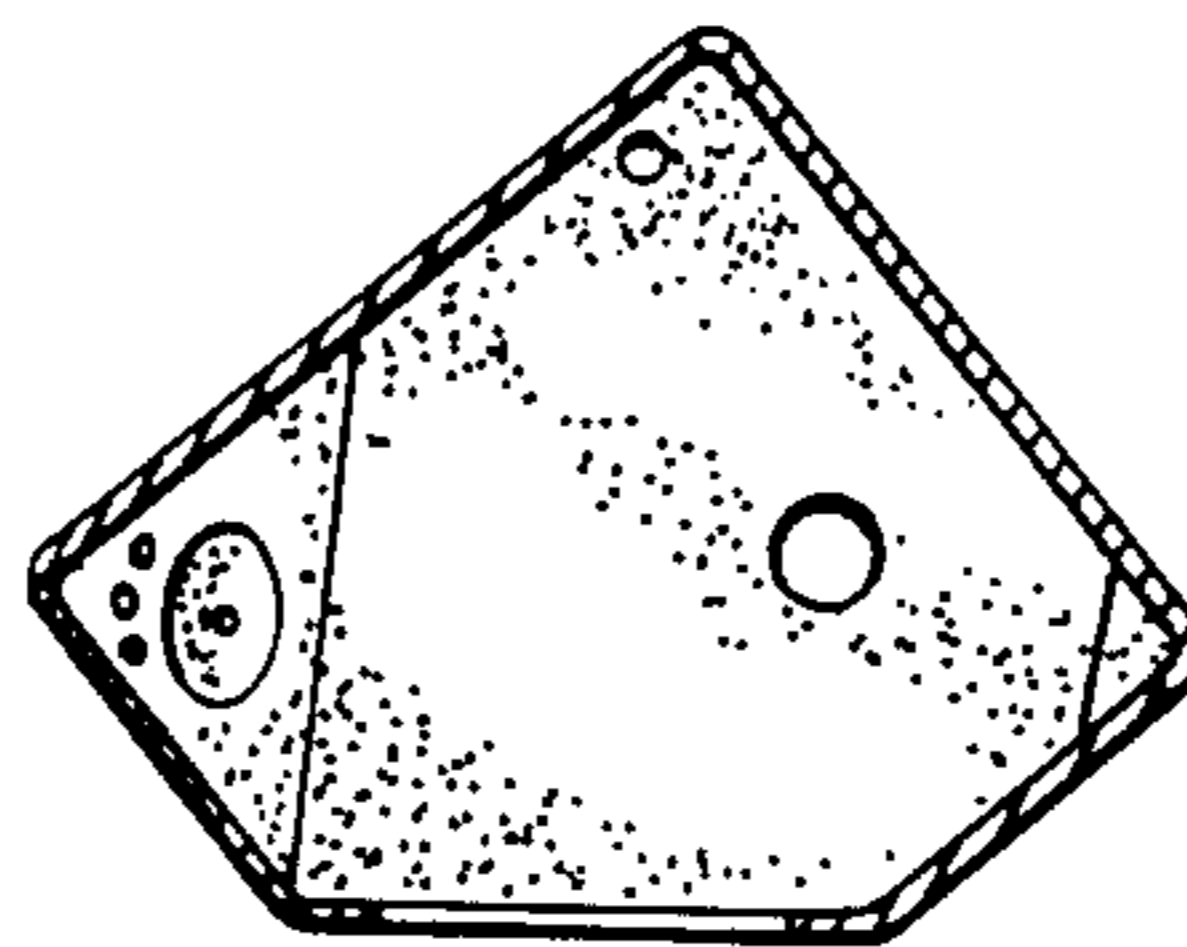

FIG. 12.