

[54] CONTAINER FOR MACHINE TOOL COOLANT

[76] Inventors: **Shirl R. Alger**, 2628 Gallio Ave., Rowland Heights, Calif. 91748; **Ronald S. Arnold**, 908 W. Oakcrest Ave., Brea, Calif. 92621; **James W. Kelso**, 1061 Chautauqua Blvd., Pacific Palisades, Calif. 90272; **Manfred Schuler**, 4100-C Patrice Road, Newport Beach, Calif. 92663

[\*\*] Term: 14 Years

[21] Appl. No.: 657,449

[22] Filed: Feb. 12, 1976

[51] Int. Cl. .... D23-01

[52] U.S. Cl. .... D23/2

[58] Field of Search ..... D23/1-4; 239/373; 220/548, 345

[56] References Cited

U.S. PATENT DOCUMENTS

920,855	5/1909	Forester .....	239/371 X
2,850,323	9/1958	Veres .....	239/424 X
3,106,346	10/1963	Thomas .....	239/371 X
3,253,788	5/1966	McHugh et al. ....	239/318 X
3,897,885	8/1975	Joyco .....	220/345

Primary Examiner—James R. Lergen  
Attorney, Agent, or Firm—William P. Green

[57] CLAIM

The ornamental design for a container for machine tool coolant, as shown.

DESCRIPTION

FIG. 1 is a perspective view taken from the front, top and right side of a container for machine tool coolant showing my new design;  
FIG. 2 is a top plan view thereof;  
FIG. 3 is a front elevational view thereof;  
FIG. 4 is a bottom plan view thereof;  
FIG. 5 is a left side elevational view thereof;  
FIG. 6 is a rear elevational view thereof; and  
FIG. 7 is a cross sectional view taken on line 7-7 of FIG. 5.

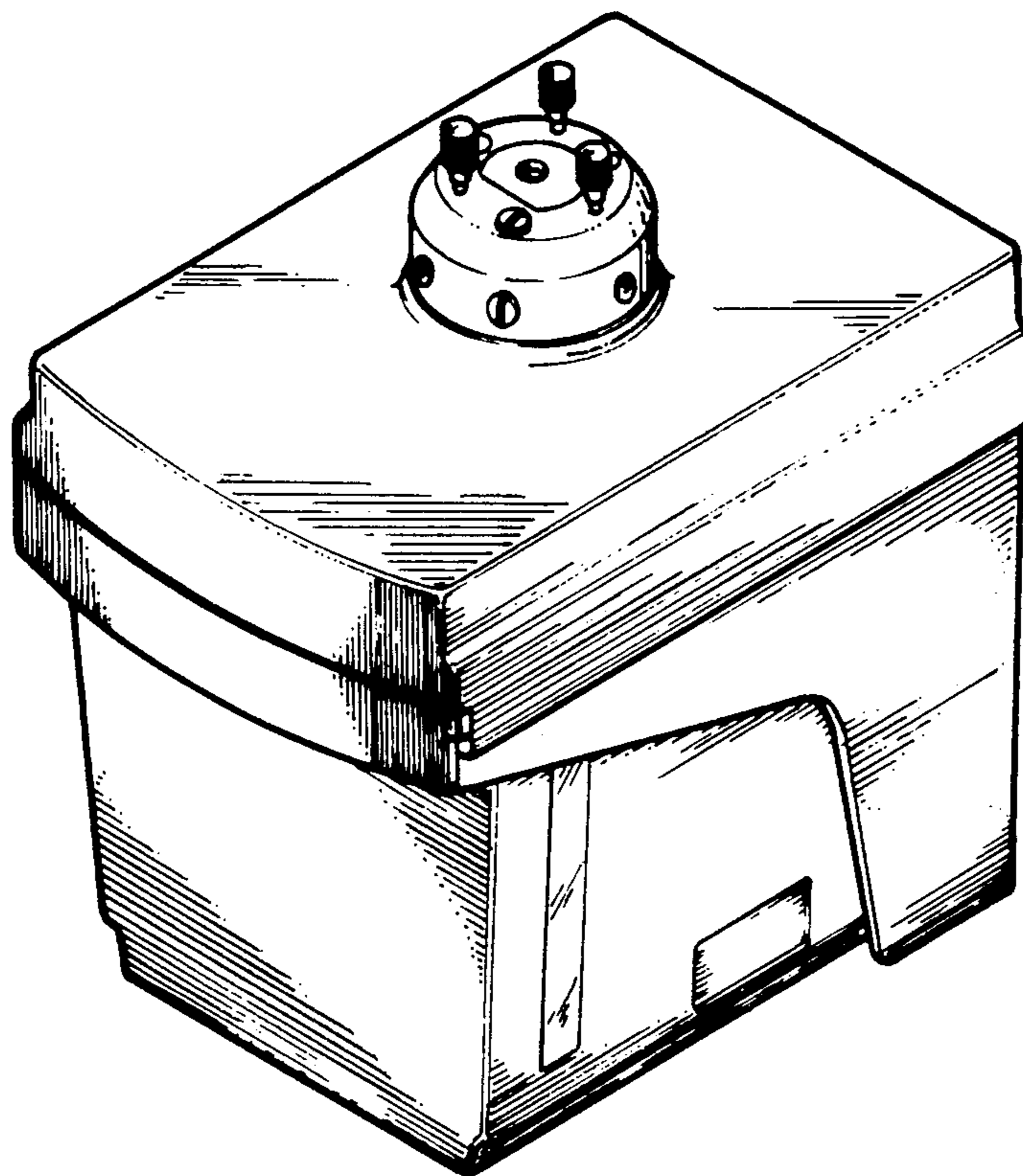

FIG. 1

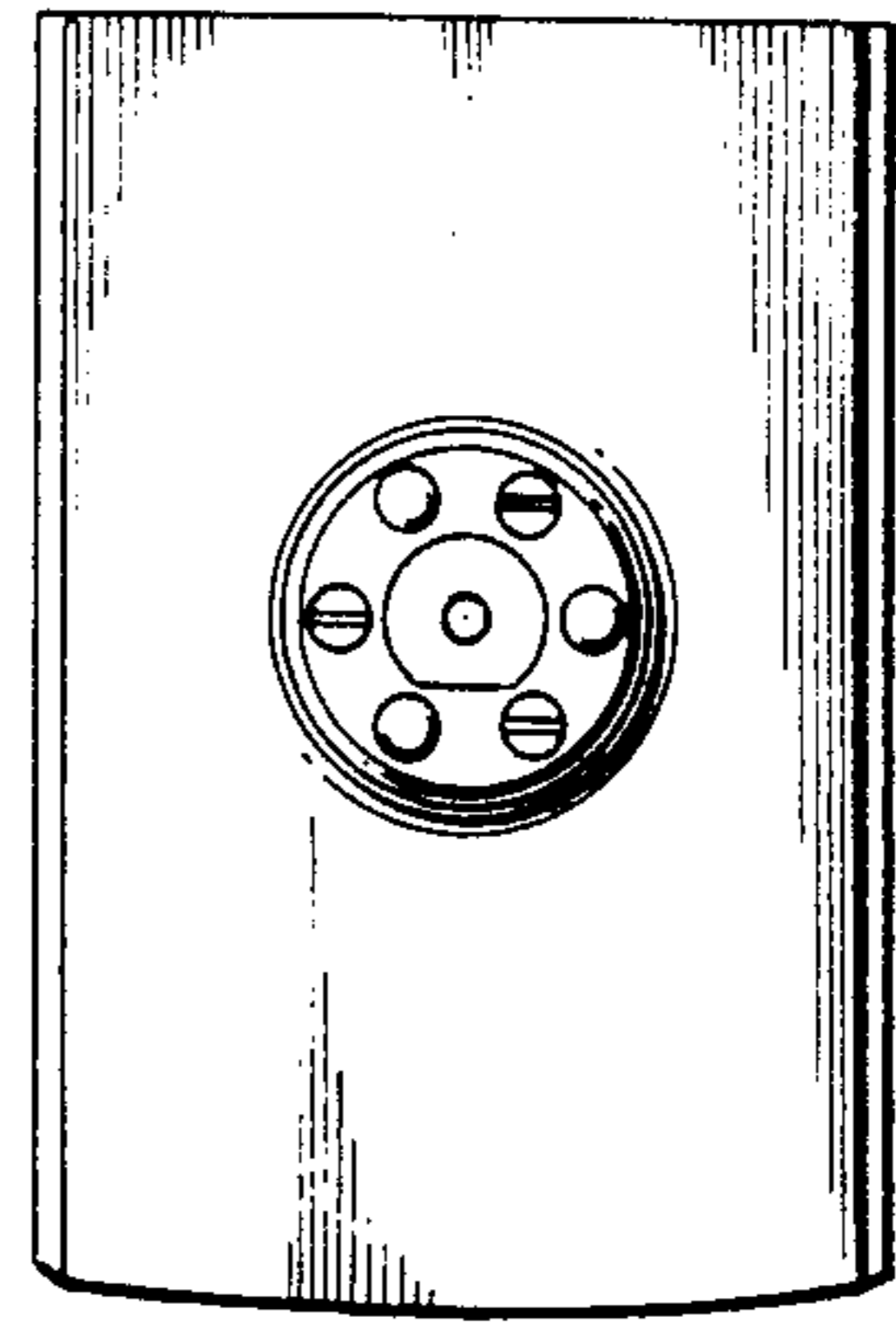
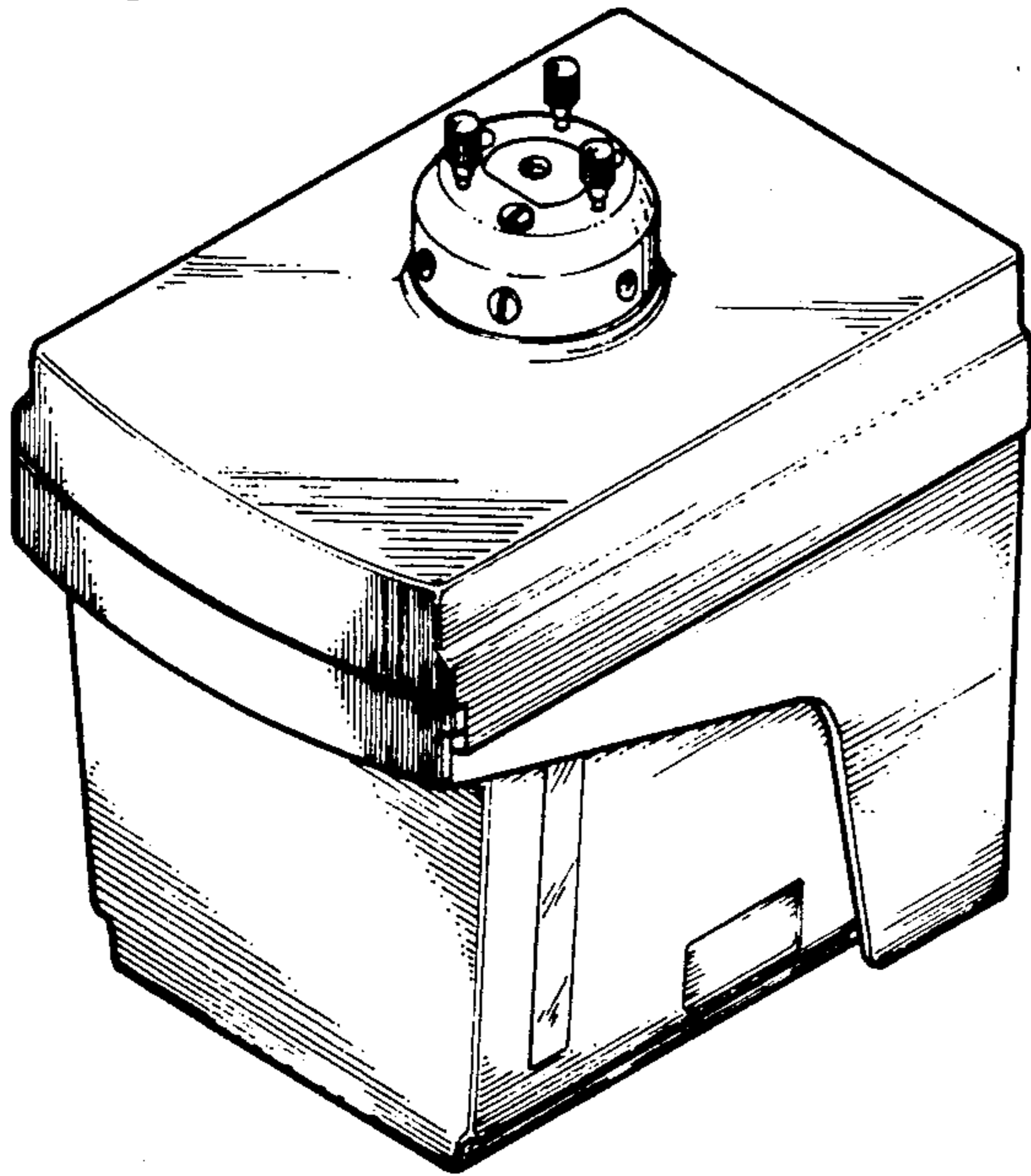

FIG. 2

FIG. 4

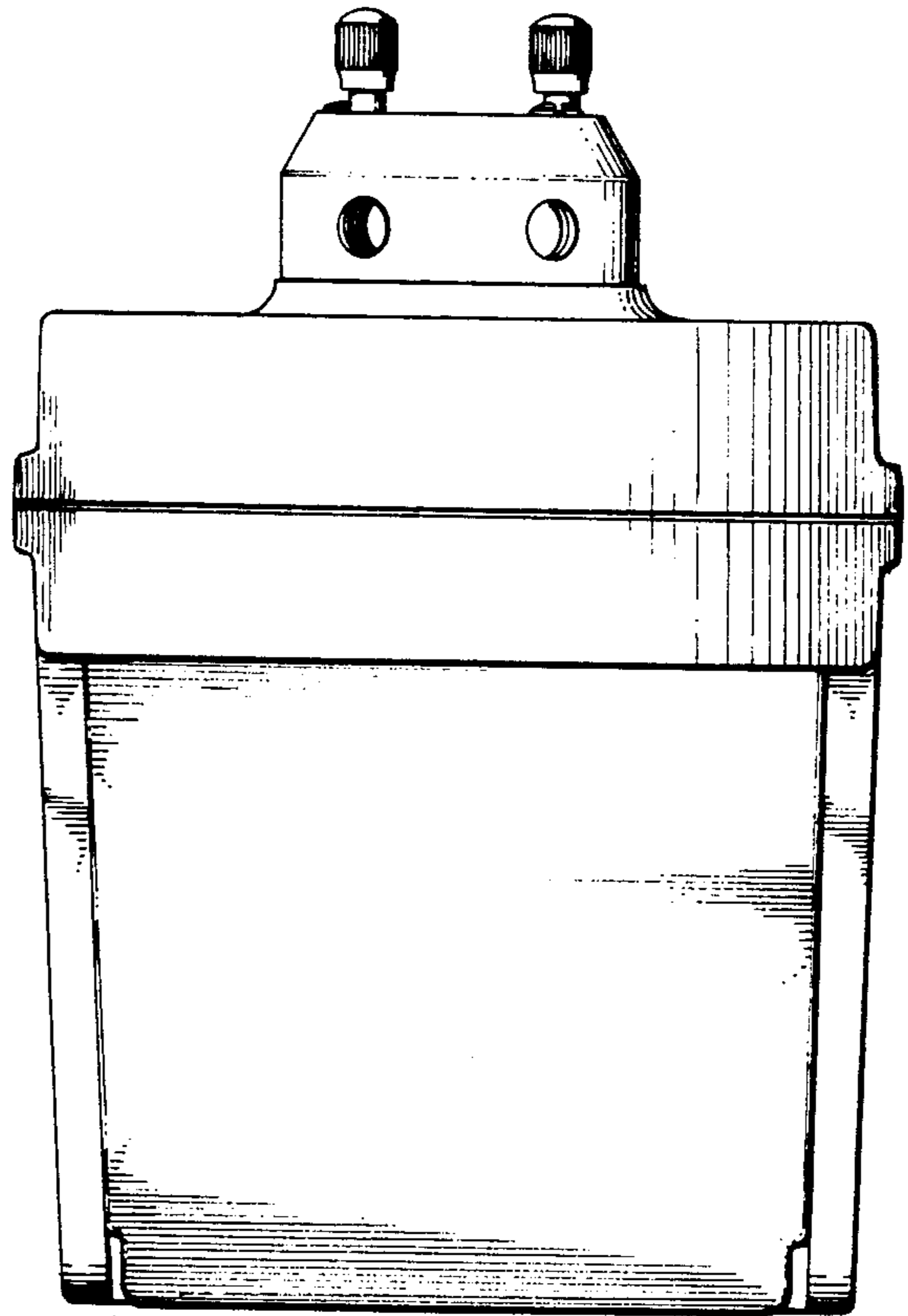
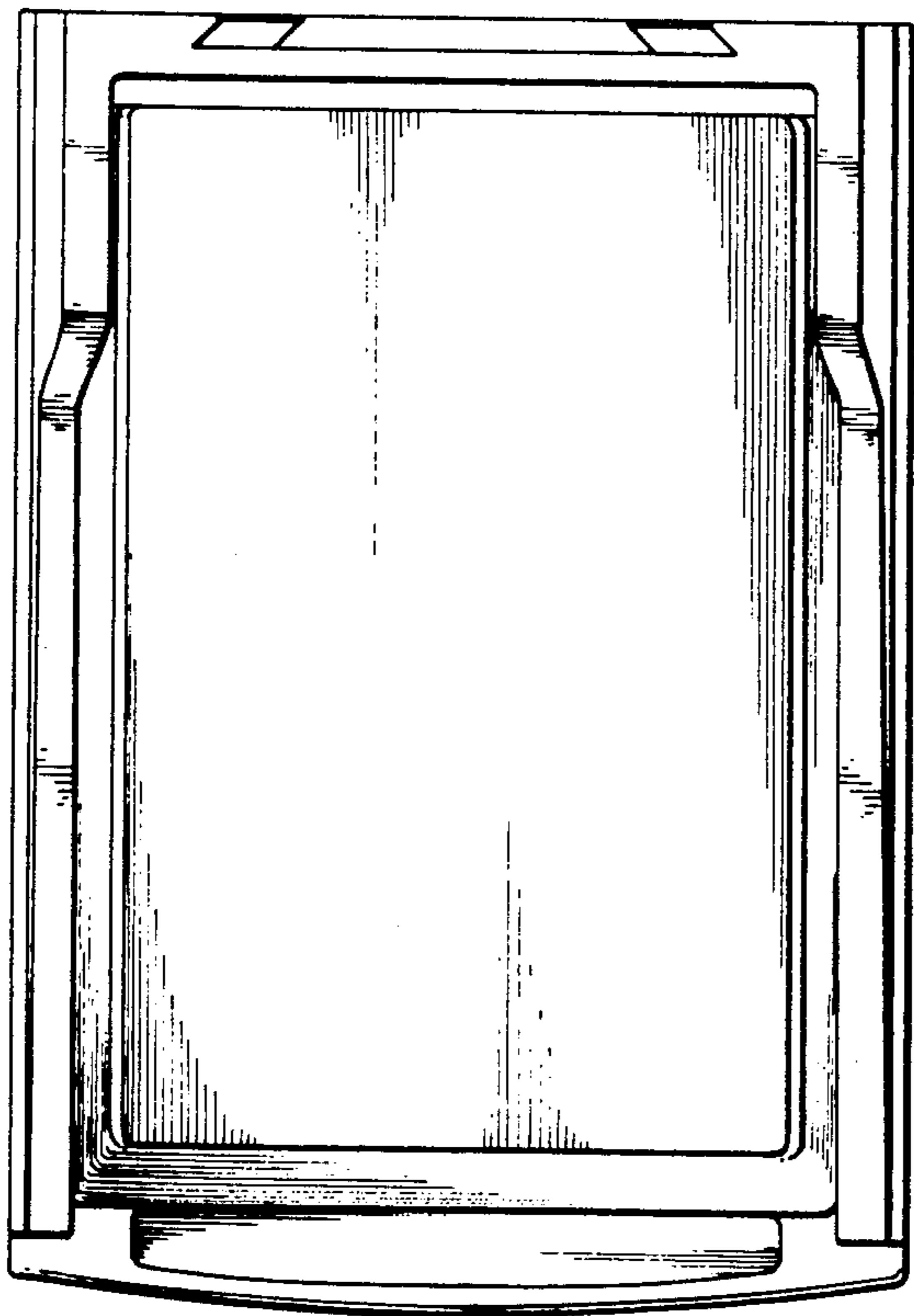

FIG. 3

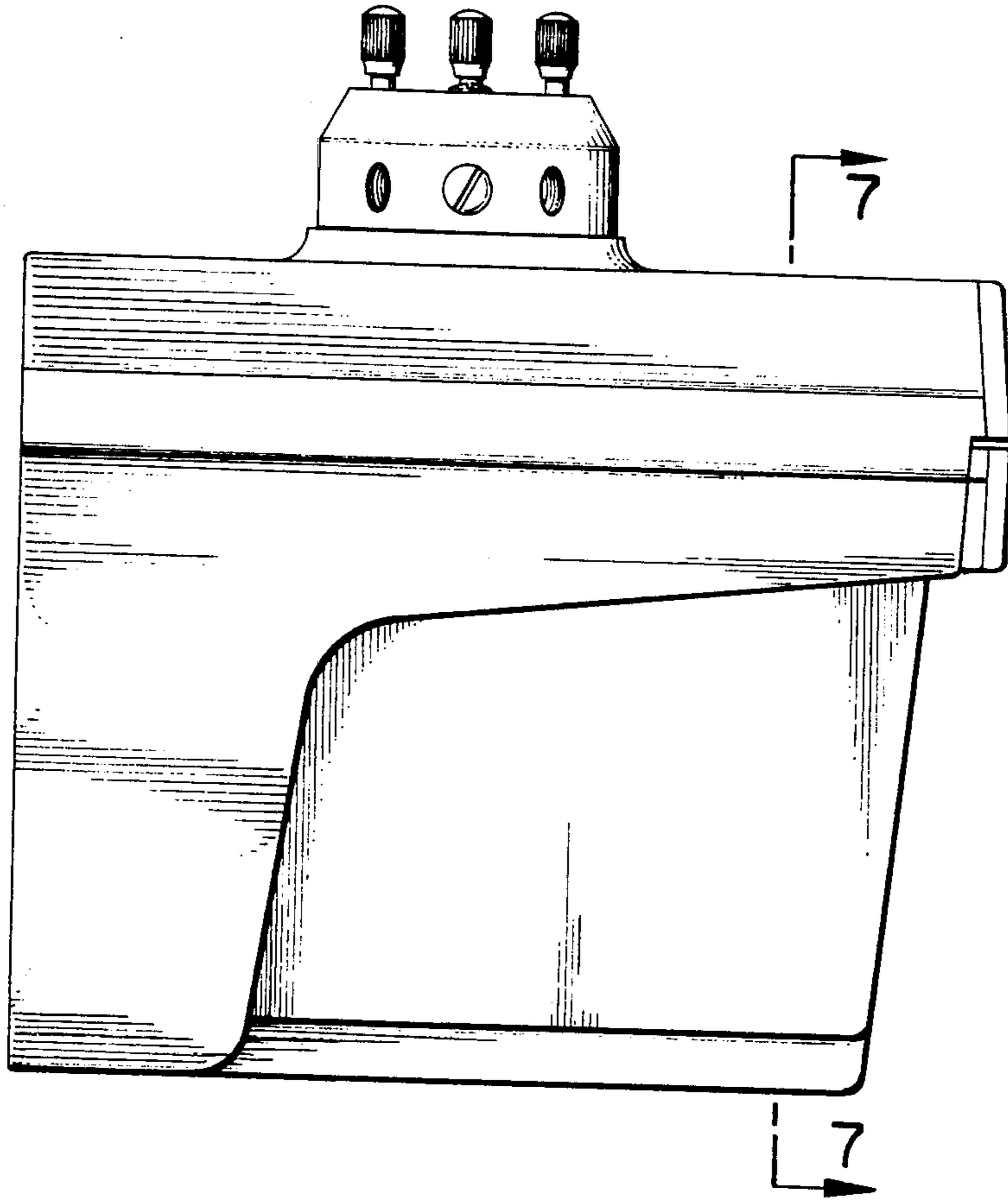

FIG. 5

FIG. 6

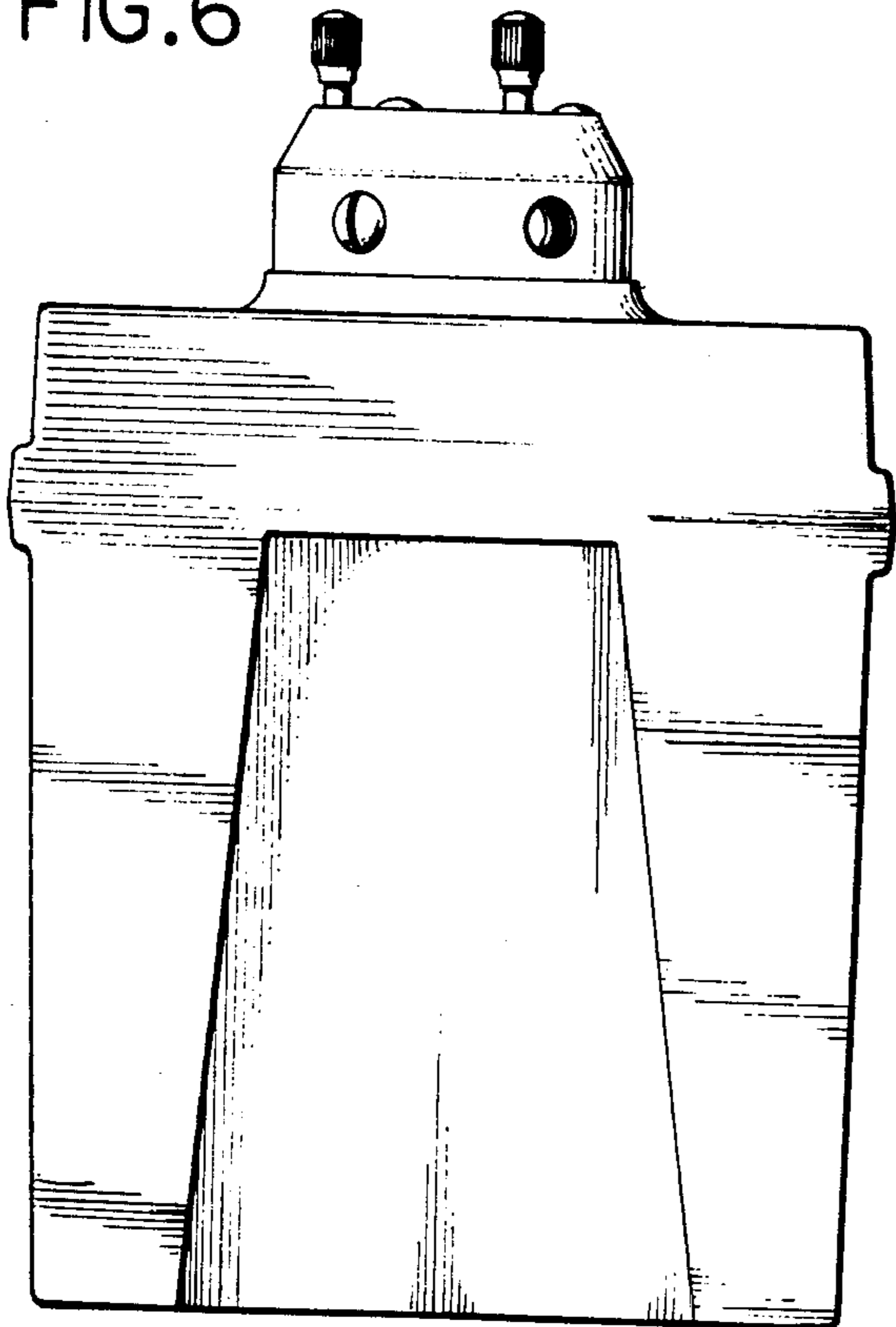

FIG. 7

