

[54] REAR-VIEW MIRROR

[76] Inventor: Raymond A. McCarroll, 1725 Newcastle, Grosse Pointe Woods, Mich. 48236

[**] Term: 14 Years

[21] Appl. No.: 614,520

[22] Filed: Sept. 18, 1975

[51] Int. Cl. D12-16

[52] U.S. Cl. D12/187

[58] Field of Search D12/187; 350/299, 307, 350/301-304

[56] References Cited

U.S. PATENT DOCUMENTS

- D. 168,589 1/1953 Pavenick D12/187
- D. 182,382 3/1958 Rossi D12/187

OTHER PUBLICATIONS

J. C. Whitney Catalog No. 325, 1974, p. 41, Sports Car

Wide Oval Mirror, second box down, top right side of page.
J. C. Whitney Catalog No. 325, 1974, p. 41, Sport Mirror, bottom right side of page.

Primary Examiner—Wallace R. Burke
Assistant Examiner—James M. Gandy

[57] CLAIM

The ornamental design for a rear-view mirror, as shown.

DESCRIPTION

FIG. 1 is a rear elevational view of a rear-view mirror showing my new design;
FIG. 2 is a side elevational view thereof, as viewed from the right side of FIG. 1;
FIG. 3 is a top plan view thereof;
FIG. 4 is a front elevational view thereof and;
FIG. 5 is a side elevational view thereof, as viewed from the left side of FIG. 1.

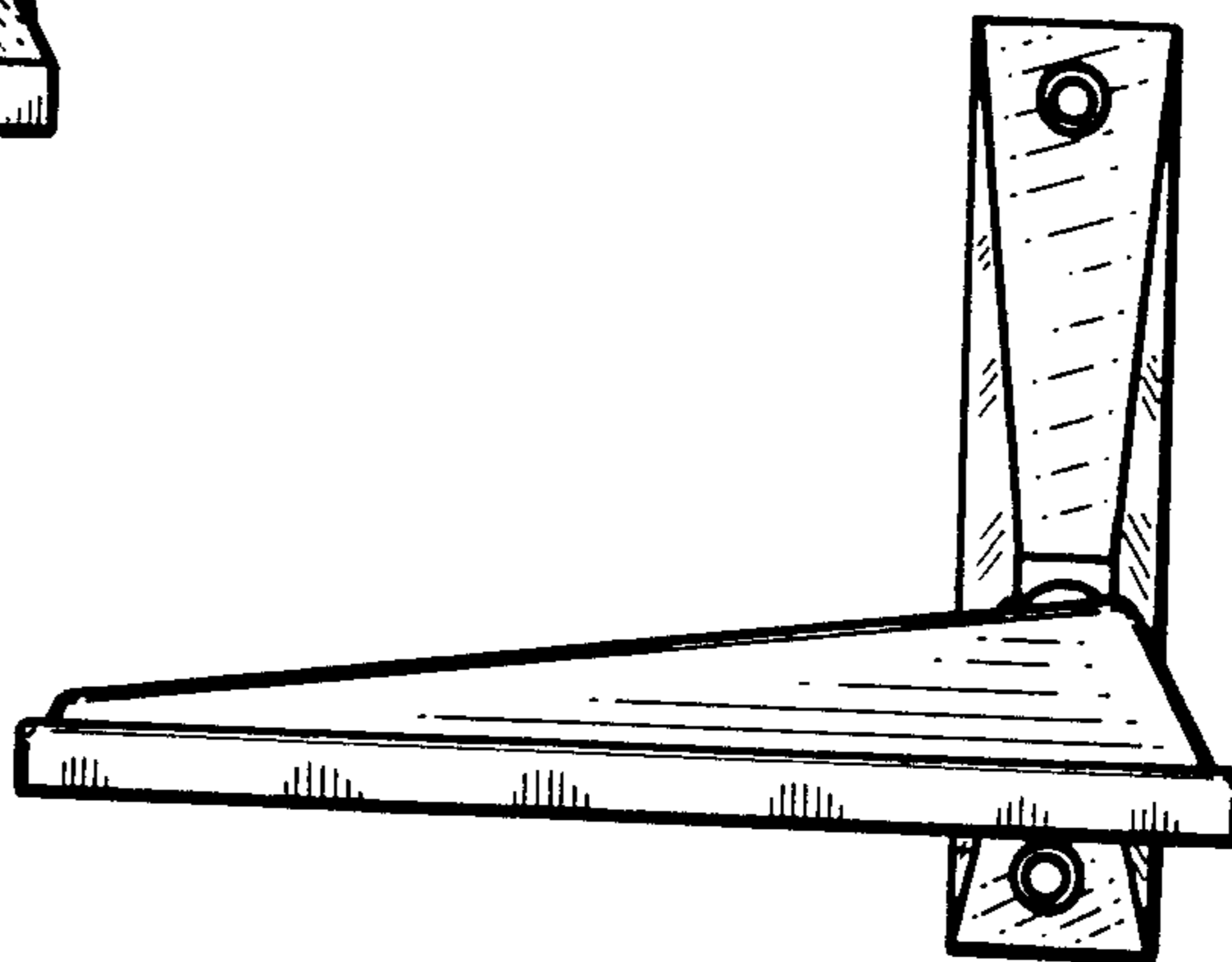
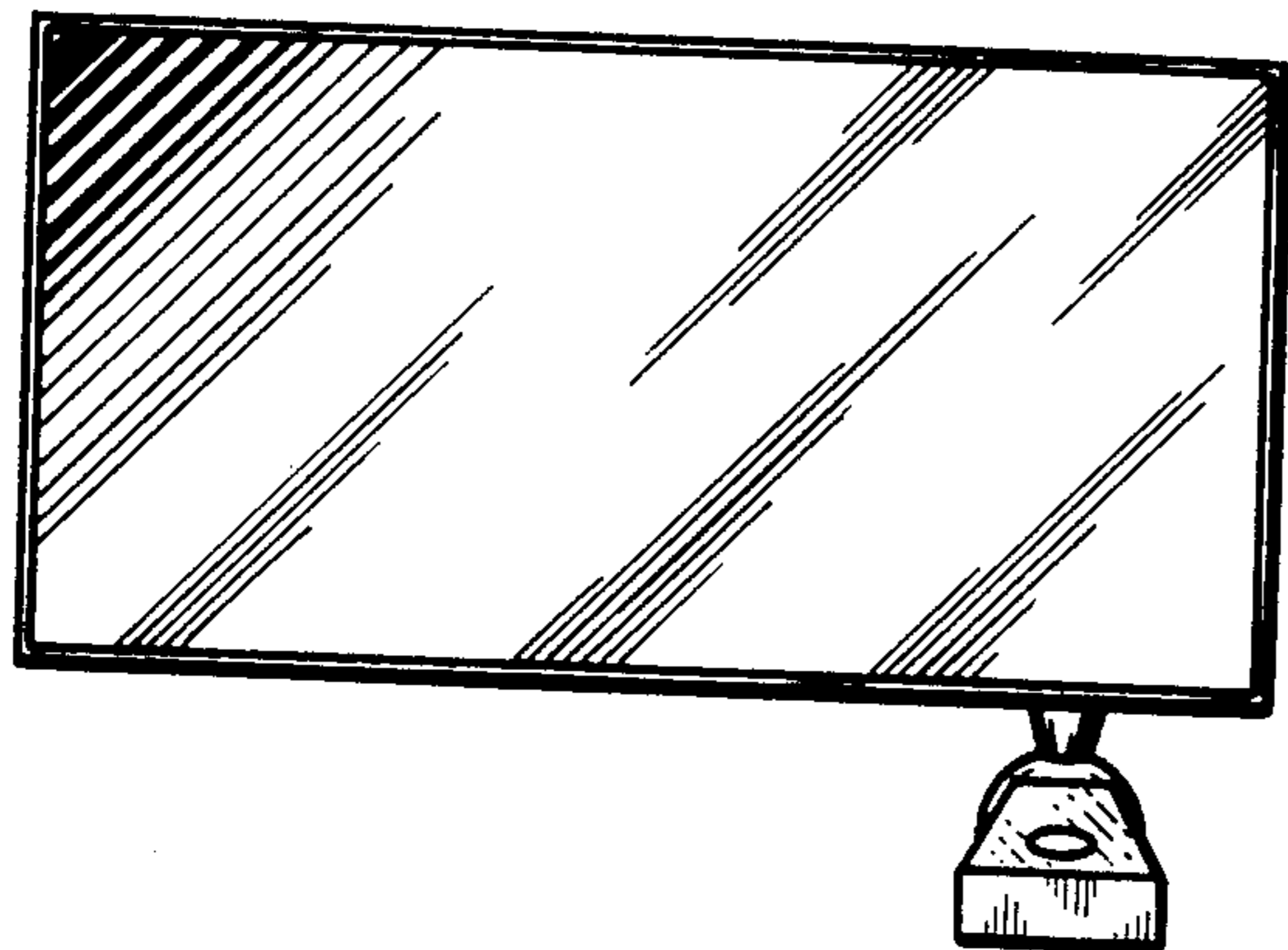

—FIG. 3

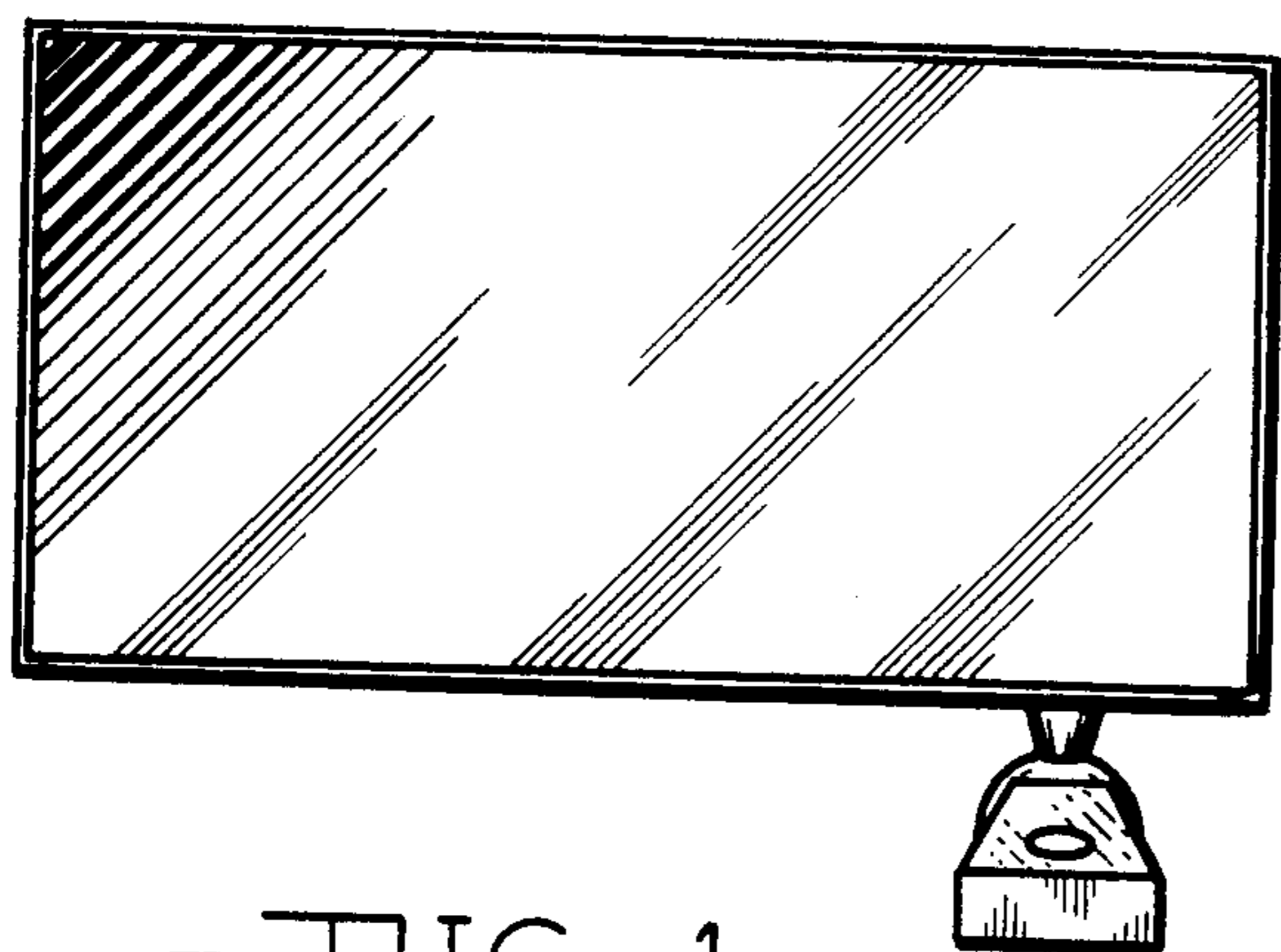
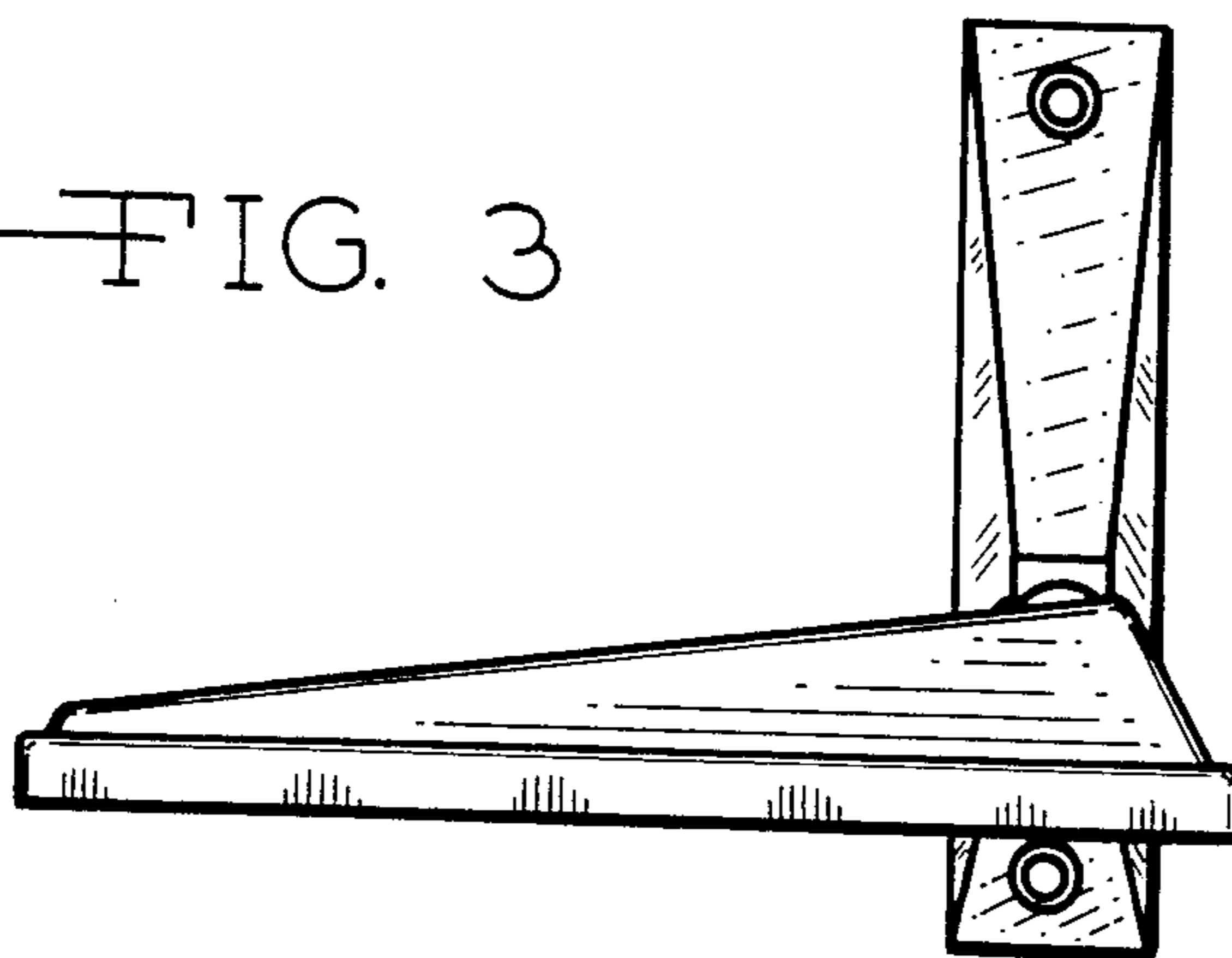

—FIG. 1

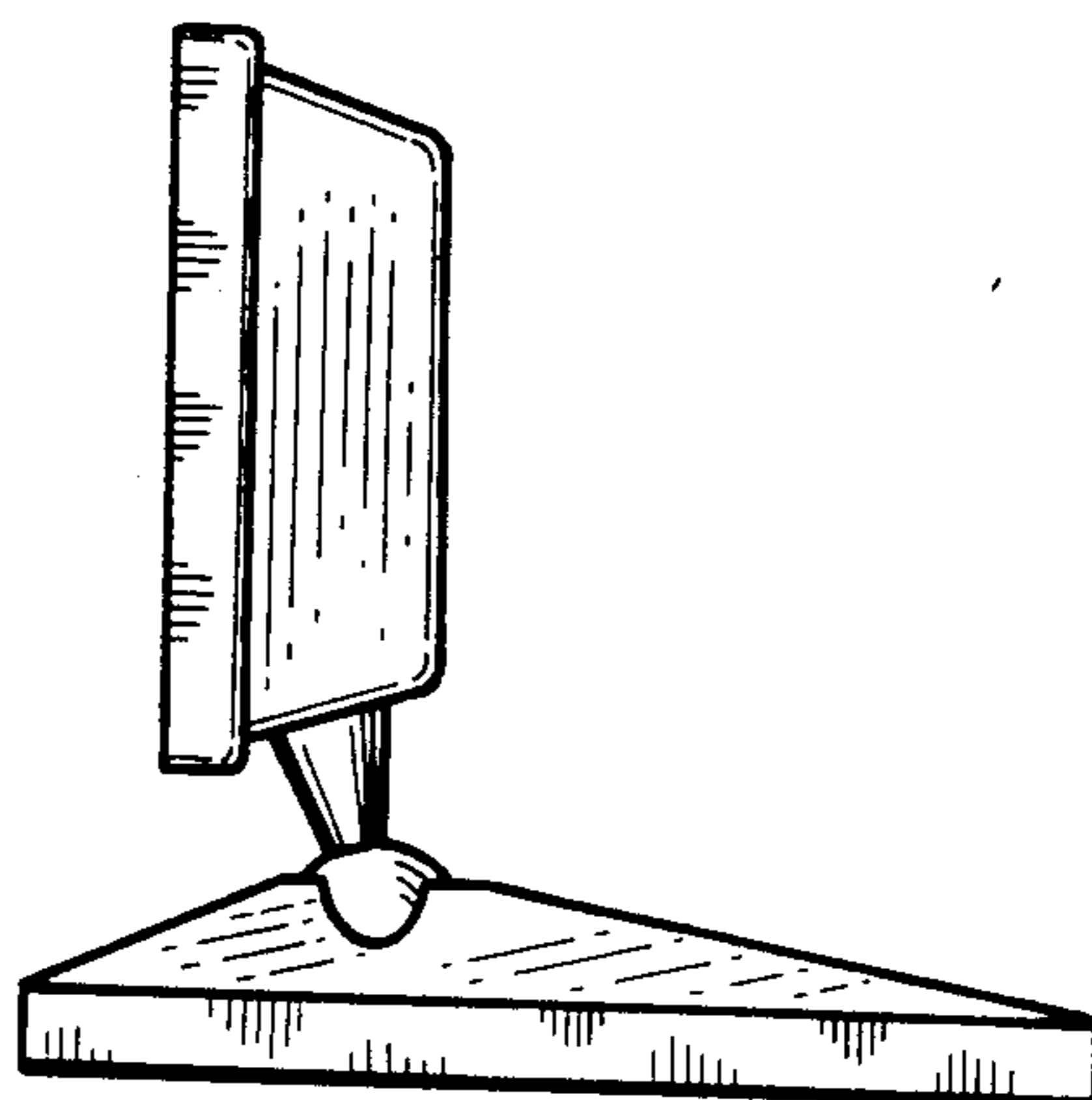

—FIG. 2

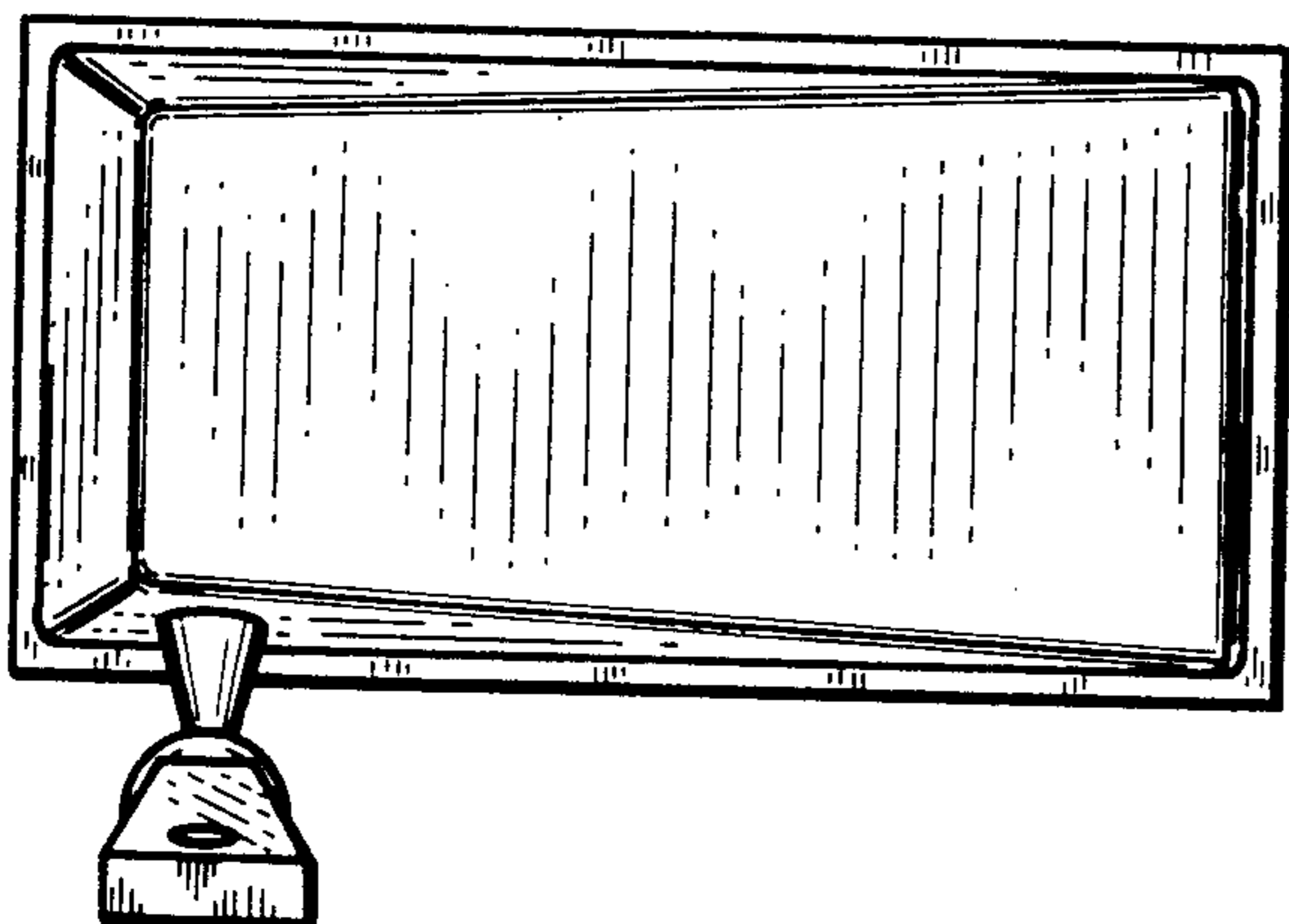

—FIG. 4

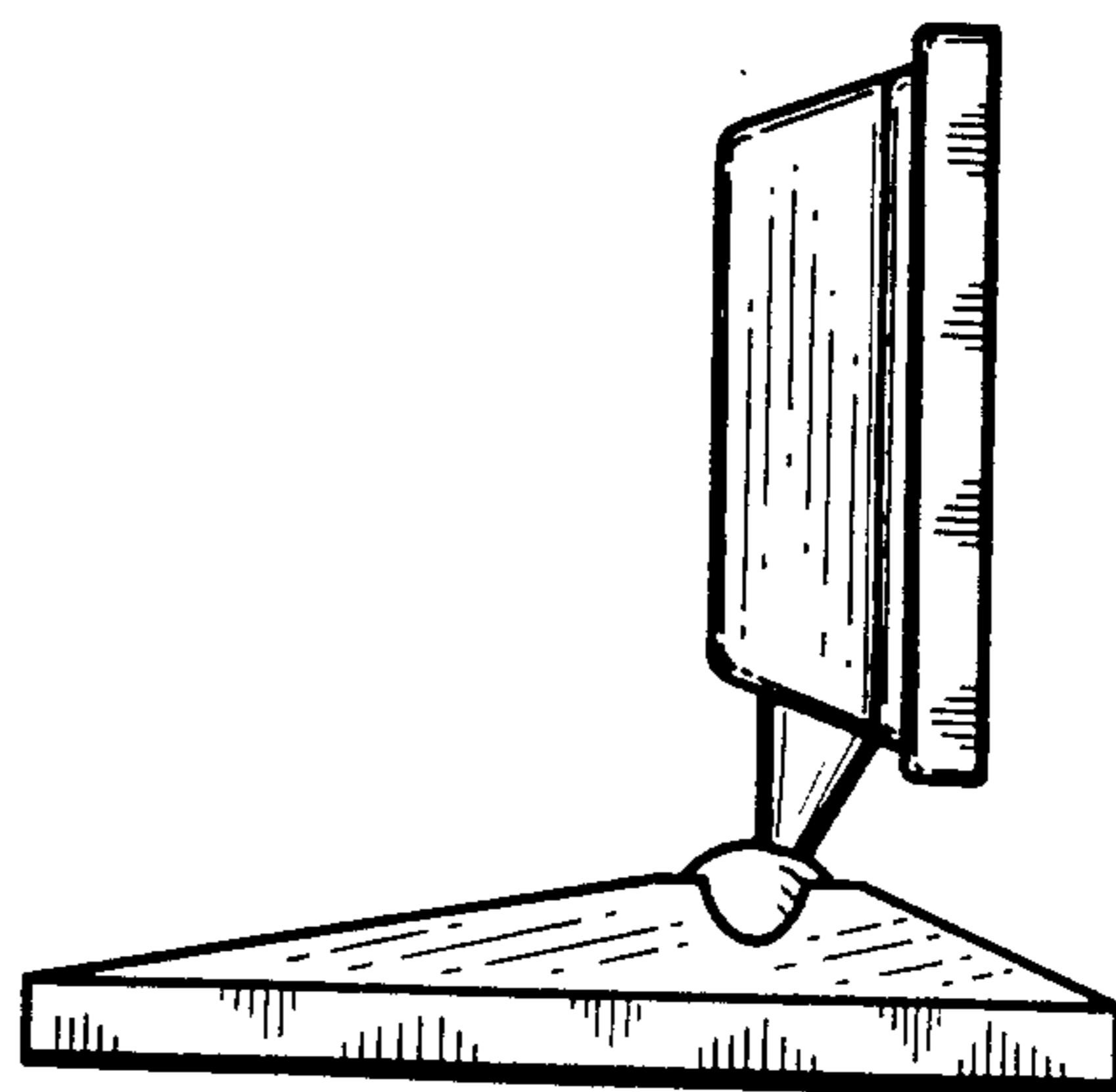

—FIG. 5