

[54] COUPLING GUARD

[76] Inventors: **Richard H. Hanson**, 1699 Alcan Drive, Menasha, Wis. 54952; **Robert D. Roedel**, 12323 Christine Drive, Wauwatosa, Wis. 53213; **Frank R. Forrest**, Box No. 1, Saxeville, Wis. 54976

[\*\*] Term: 7 Years

[21] Appl. No.: 586,993

[22] Filed: June 16, 1975

[51] Int. Cl. .... D15-99

[52] U.S. Cl. .... D15/148

[58] Field of Search ..... D23/40-47;  
D55/1 G, 1 H; 74/16, 609; 220/DIG. 25;  
D15/138, 141, 148, 199

[56] References Cited

U.S. PATENT DOCUMENTS

2,512,528 6/1950 Holman ..... 74/609 X  
2,775,905 1/1957 Jackson ..... 74/609

D. 59,358 10/1921 Kanev ..... D55/1 H  
D. 199,865 12/1964 Wellaver ..... D55/1 G  
D. 225,684 12/1972 Bogan ..... D55/1 G

Primary Examiner—James R. Largen  
Attorney, Agent, or Firm—Ronald E. Barry

[57] CLAIM

The ornamental design for a coupling guard, as shown.

DESCRIPTION

FIG. 1 is a front perspective view of a coupling guard showing our new design;  
FIG. 2 is a rear perspective view thereof;  
FIG. 3 is a front elevational view thereof;  
FIG. 4 is a rear elevational view thereof;  
FIG. 5 is a top plan view thereof;  
FIG. 6 is a bottom plan view thereof;  
FIG. 7 is an elevational view taken from one side thereof; and  
FIG. 8 is an elevational view taken from the side opposite that shown in FIG. 7.

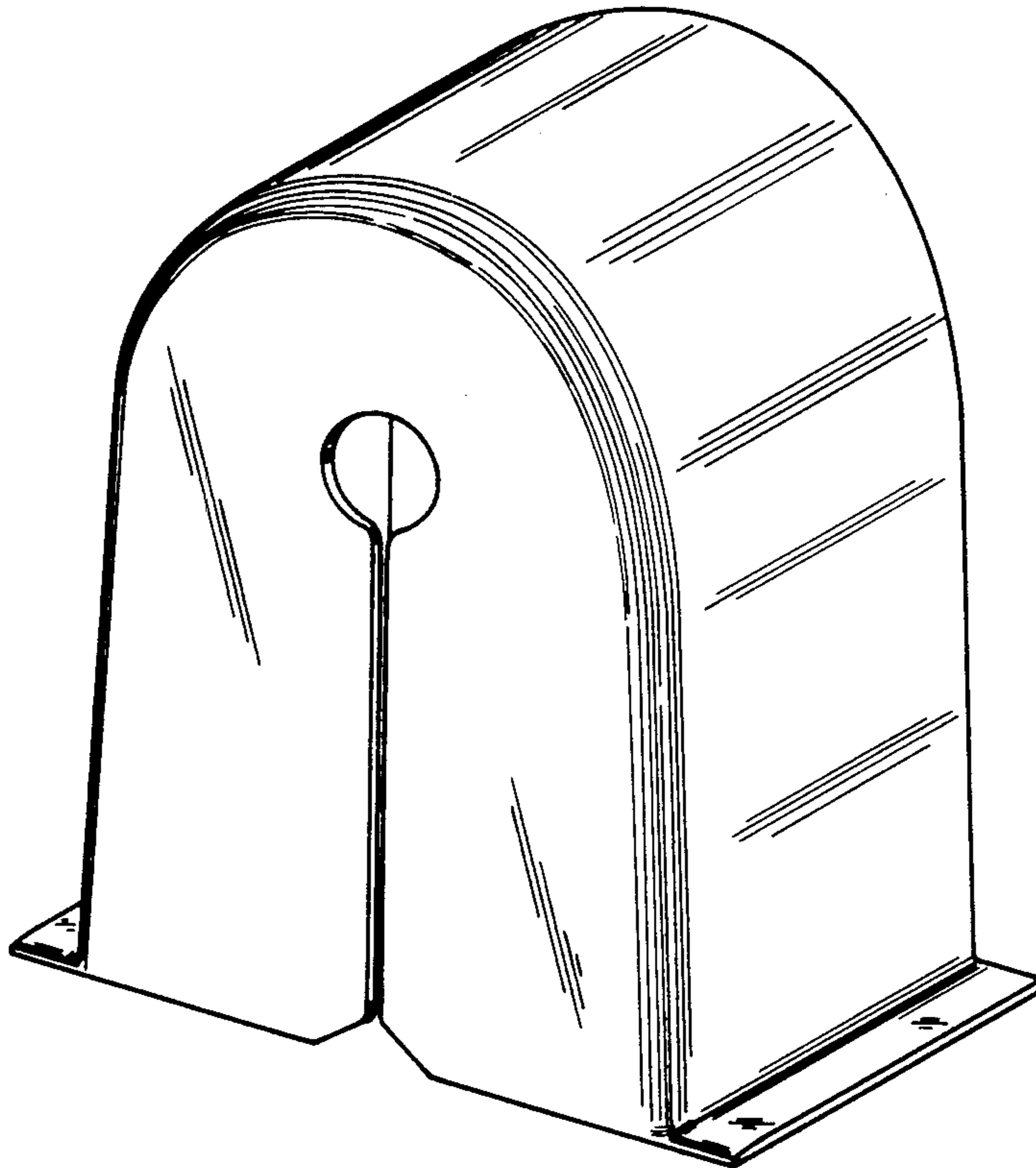

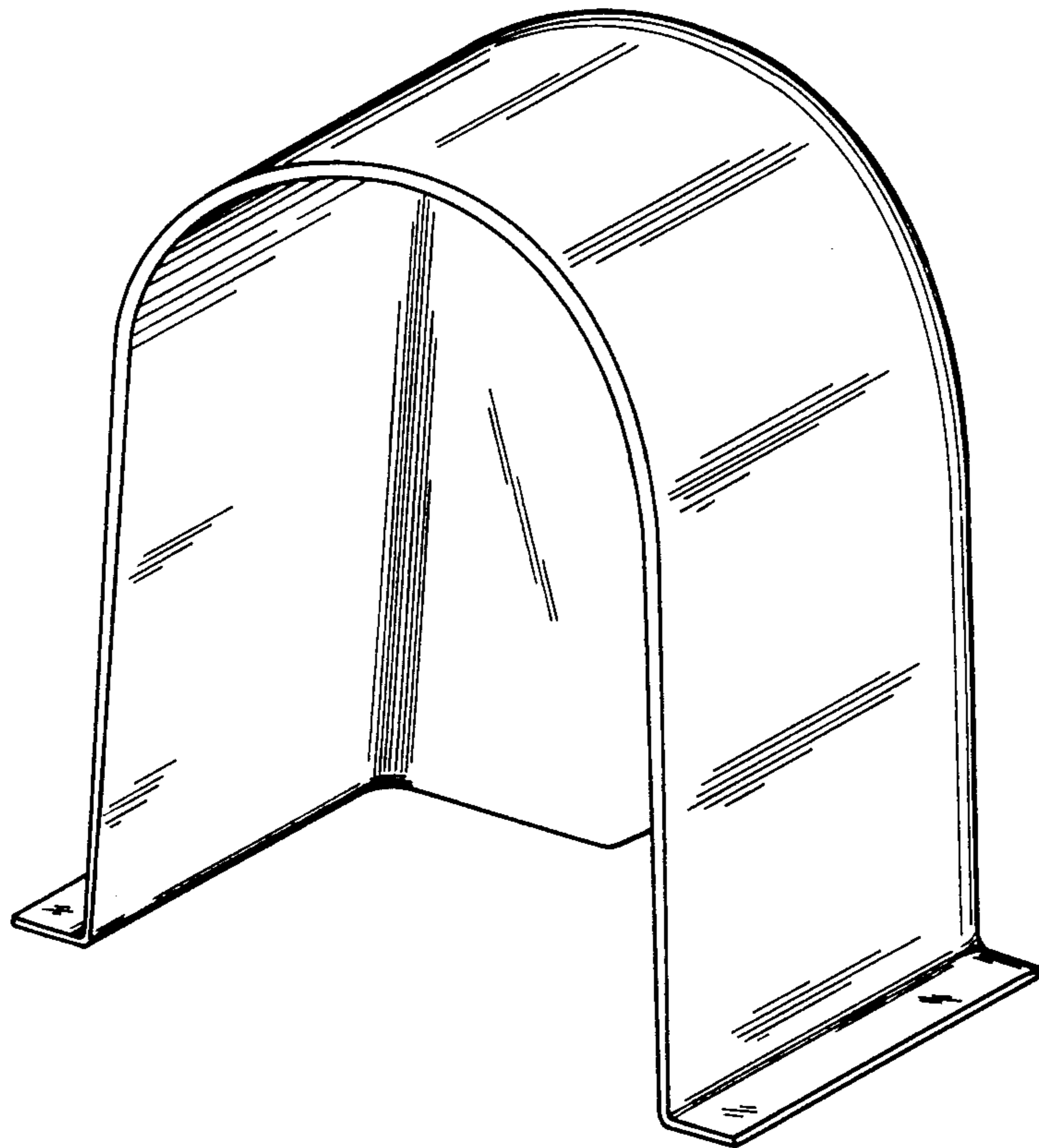

FIG. 2

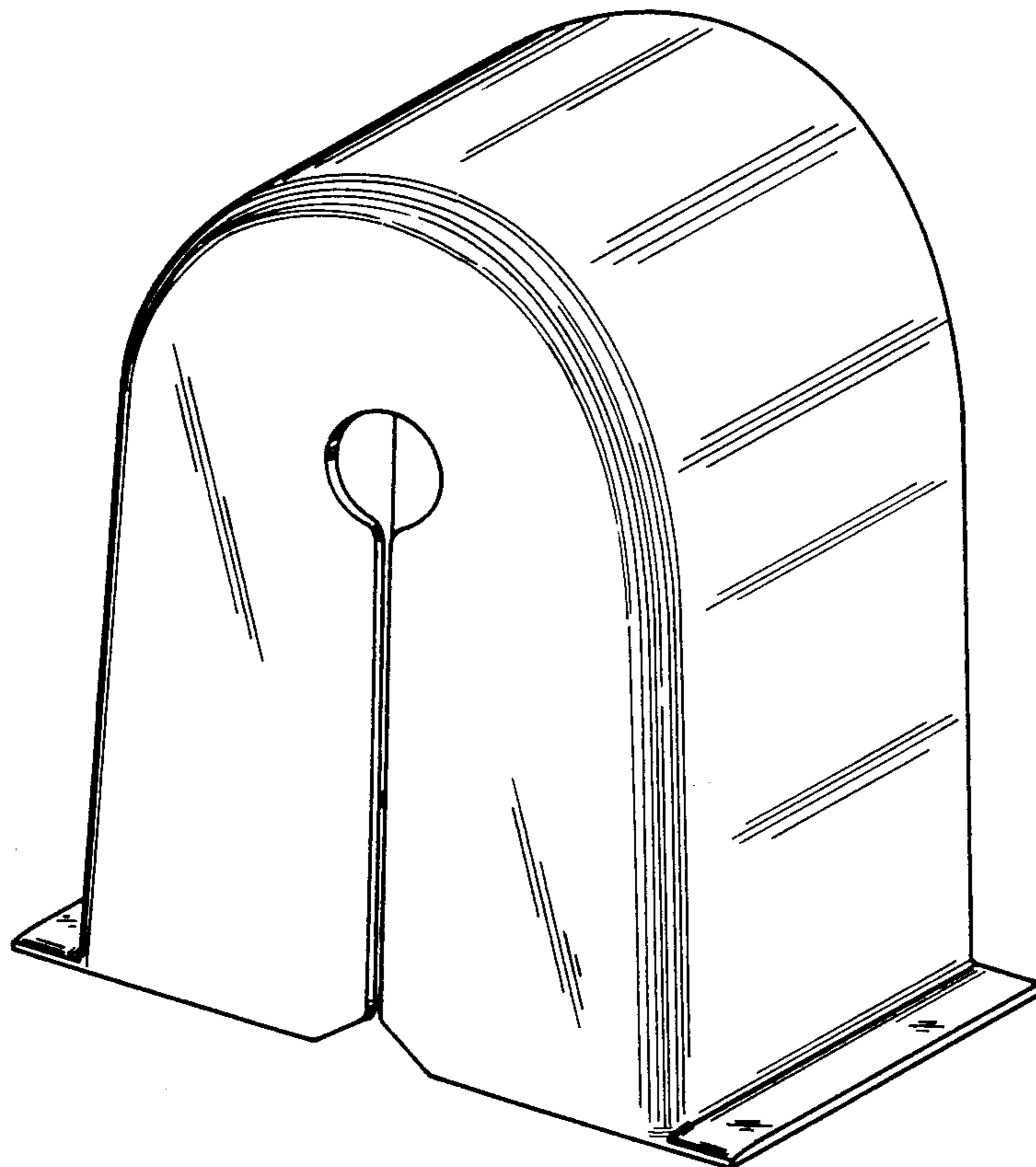

FIG. 1

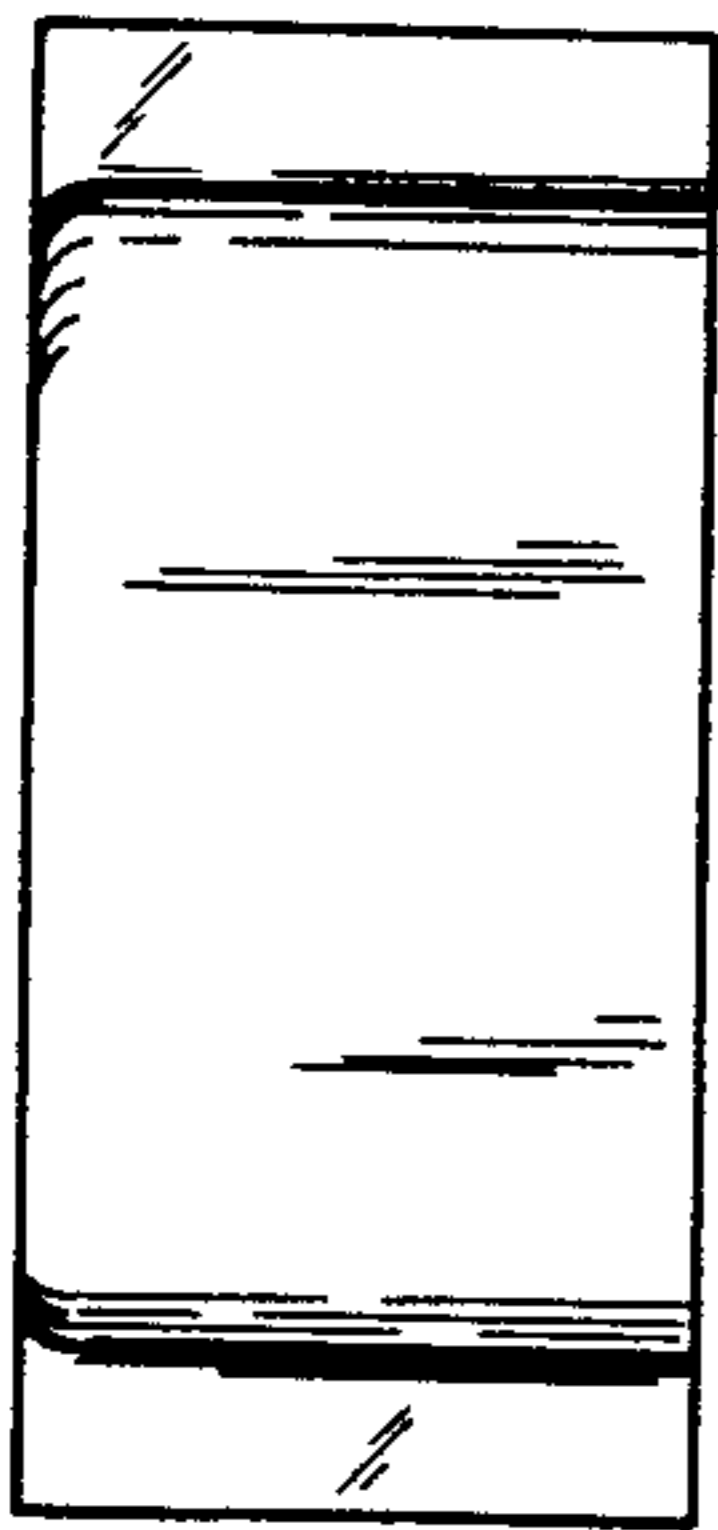

FIG. 5

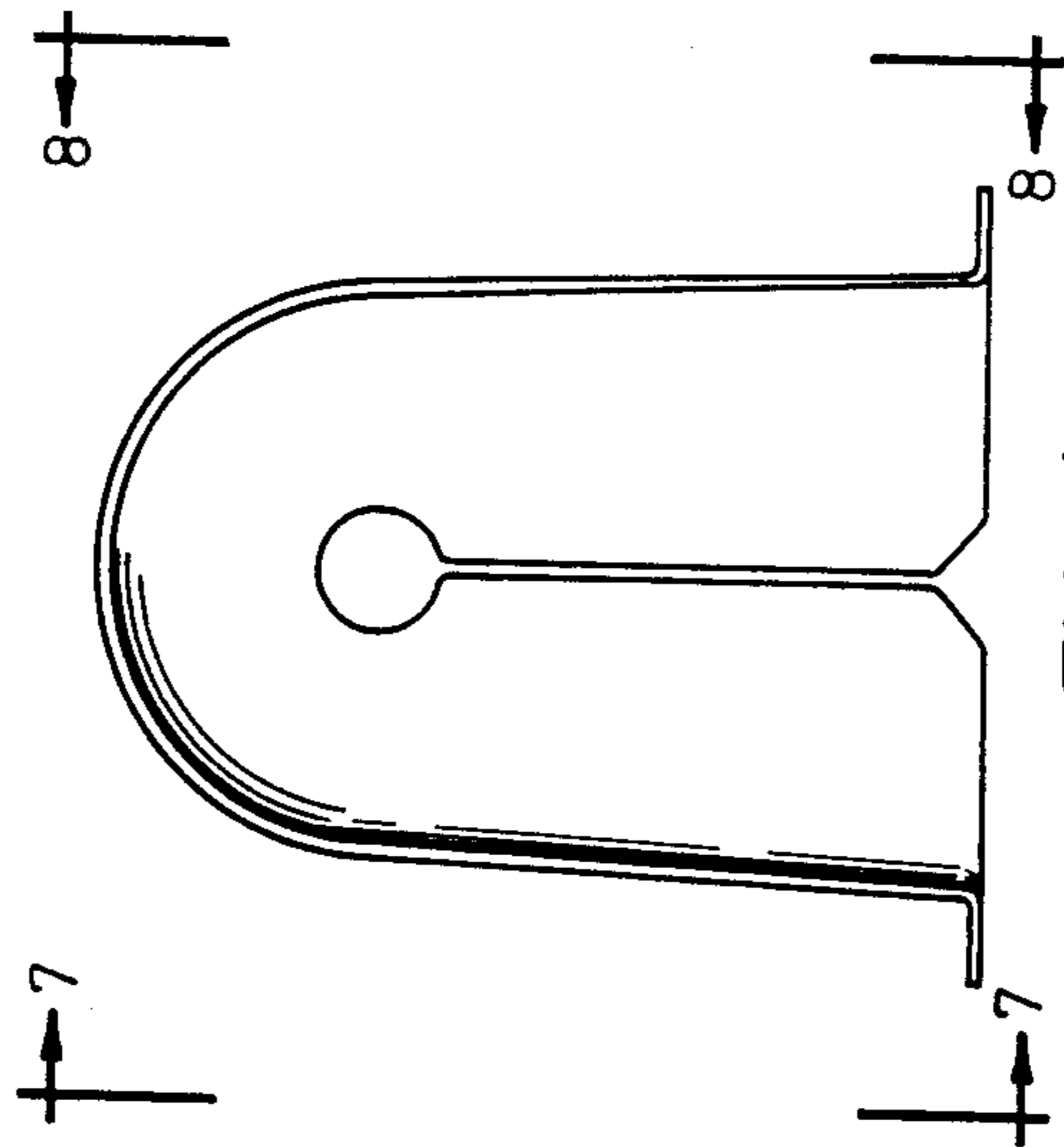

FIG. 4

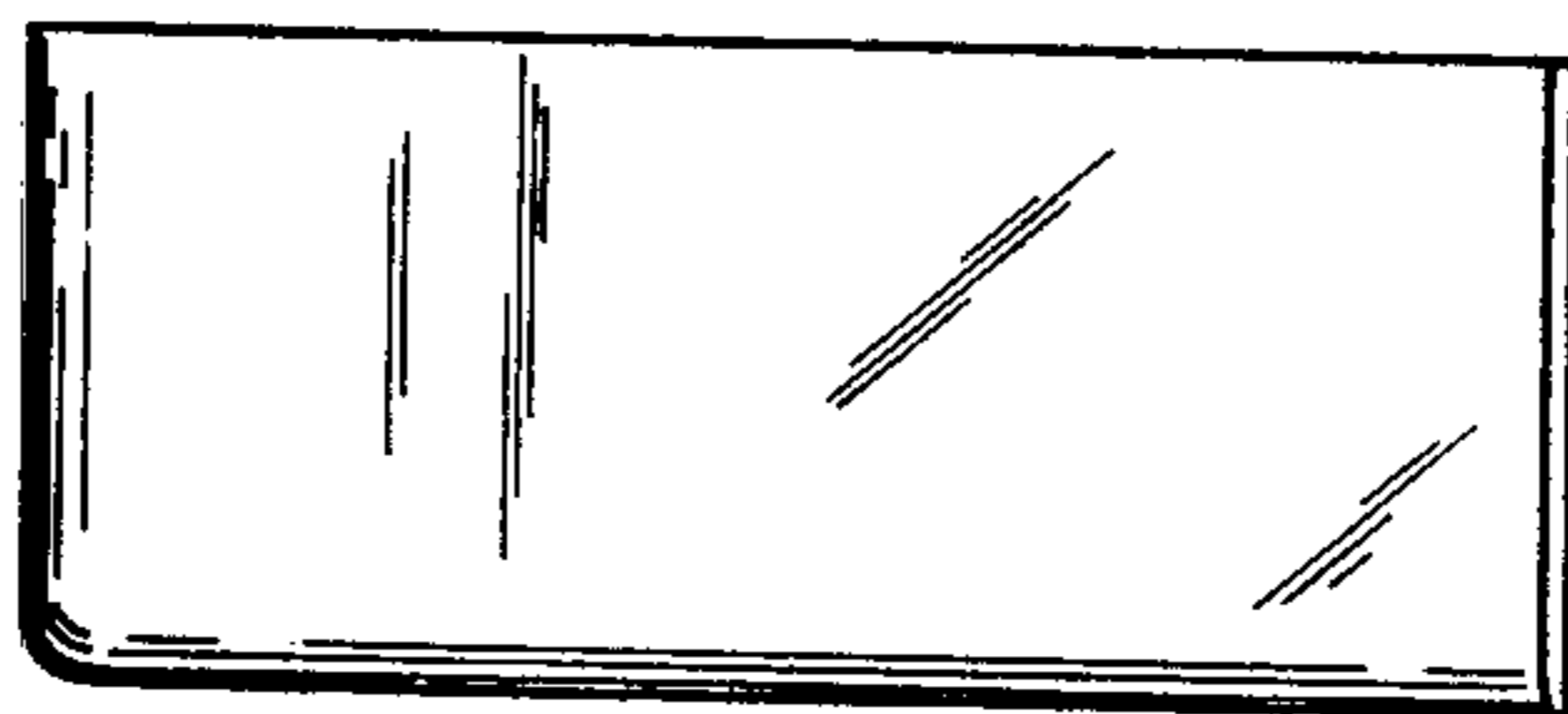

FIG. 7

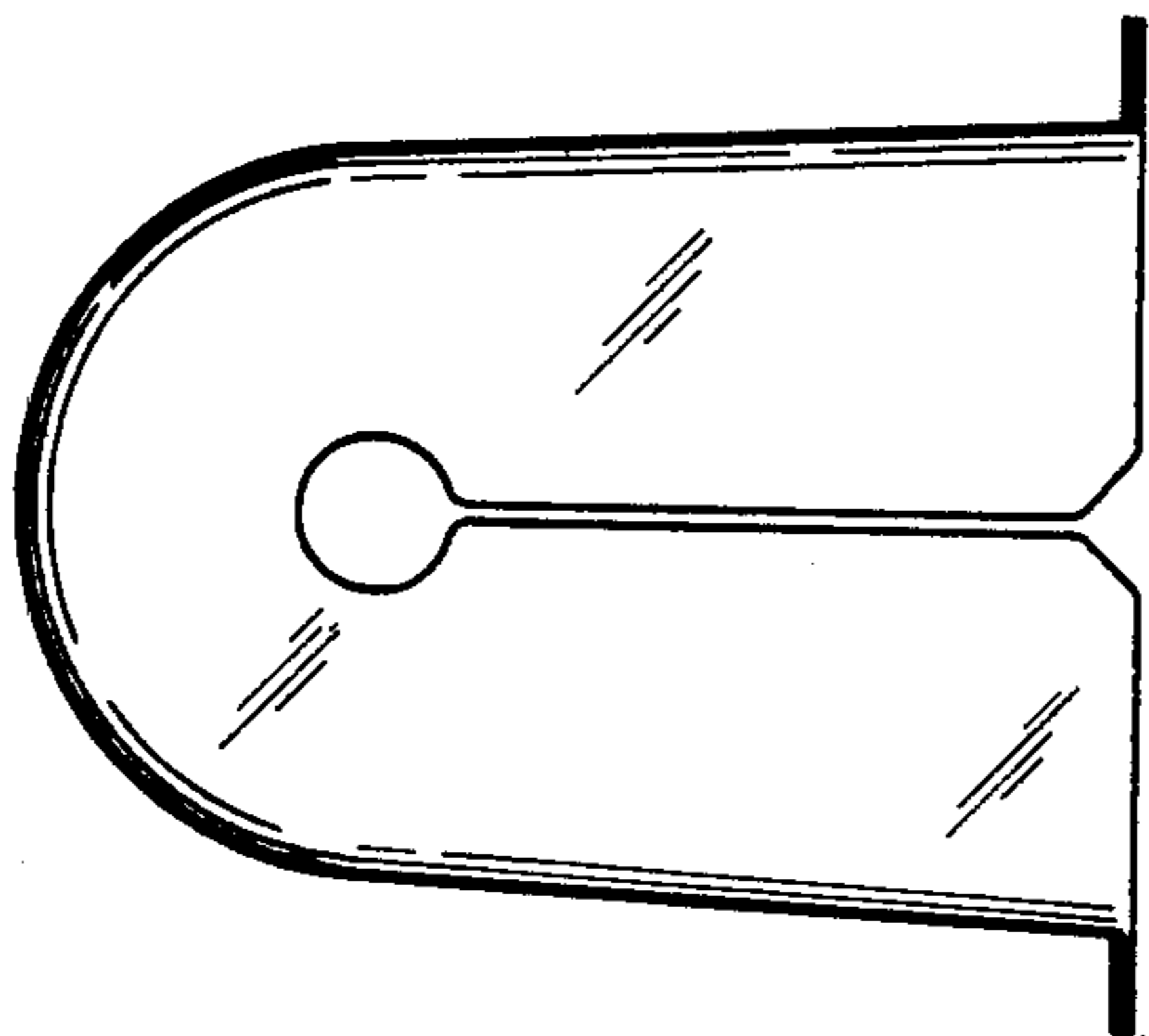

FIG. 3

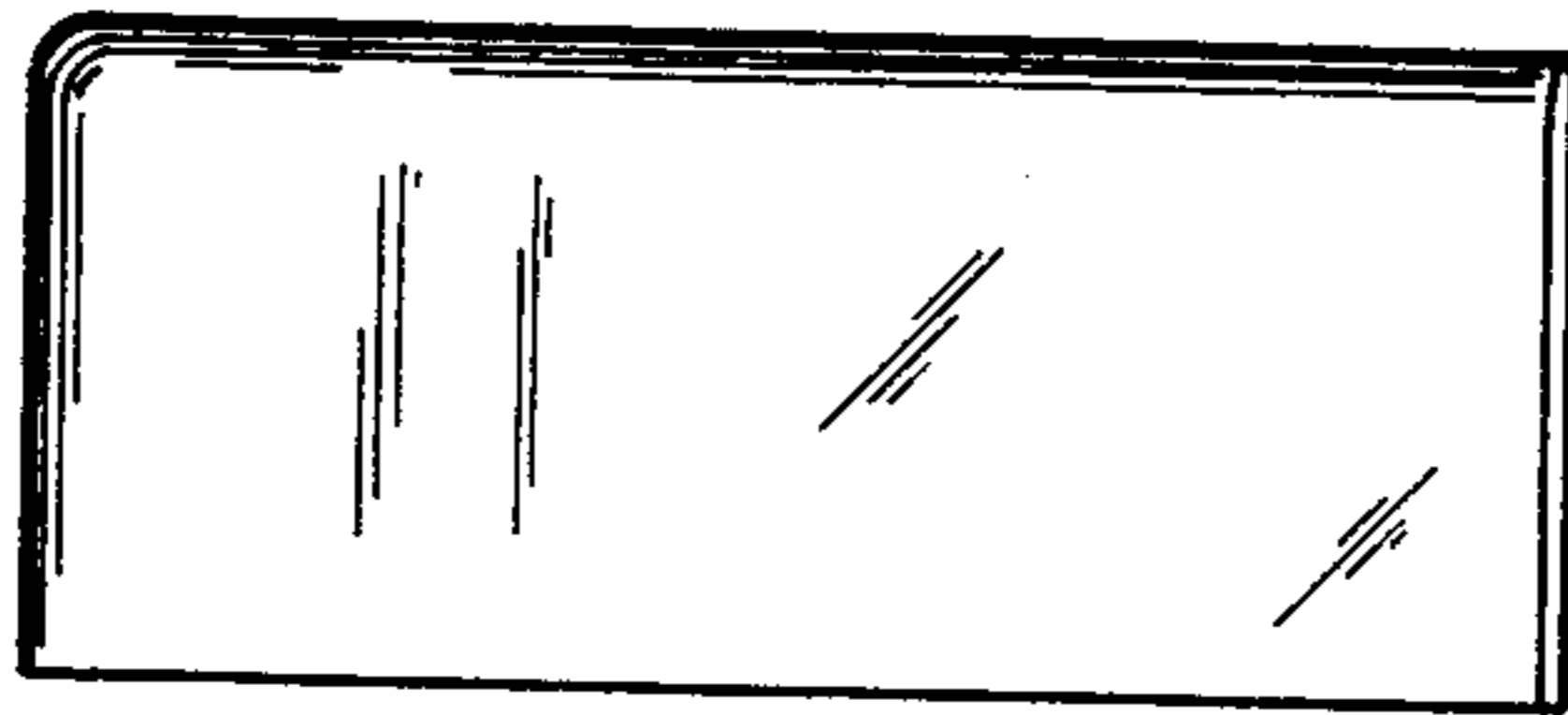

FIG. 8

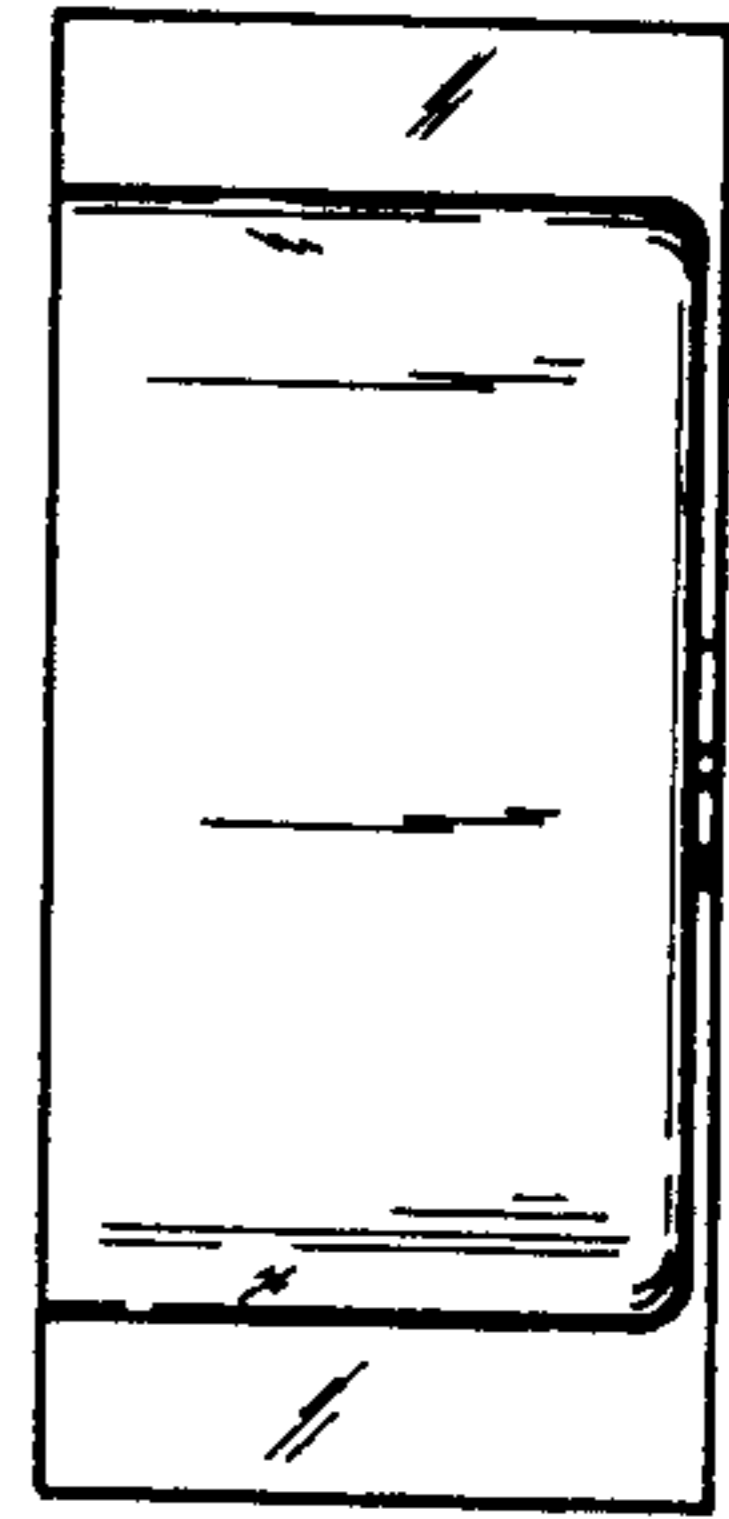

FIG. 6