

[54] BRACKET FOR GARMENT HANGERS OR THE LIKE

[76] Inventor: Georges Lallement, 115, rue Pelleport, 75020 Paris, France

[\*\*] Term: 14 Years

[21] Appl. No.: 639,122

[22] Filed: Dec. 9, 1975

[30] Foreign Application Priority Data

June 20, 1975 France ..... 75.73957

[51] Int. Cl. .... D6-04; D8-08

[52] U.S. Cl. .... D6/116

[58] Field of Search ..... D6/113, 114, 116, 117, D6/118, 120, 124, 137; D8/254, 233, 235, 246; 211/100; 223/85; 248/304, 308

[56] References Cited

U.S. PATENT DOCUMENTS

2,268,894 1/1942 Ogren ..... 211/100

2,459,909 1/1949 Alofs ..... D6/256  
D. 157,911 3/1950 Schwartz et al. .... D8/254  
D. 181,137 10/1957 Furlong ..... D8/246

Primary Examiner—Wallace R. Burke  
Assistant Examiner—B. J. Bullock  
Attorney, Agent, or Firm—Irvin S. Thompson

[57] CLAIM

The ornamental design for a bracket for garment hangers or the like, as shown.

DESCRIPTION

FIG. 1 is a side elevational view of a bracket for garment hangers or the like showing my new design; FIG. 2 is a top plan view thereof; FIG. 3 is a bottom plan view thereof; FIG. 4 is an enlarged front elevational view thereof; FIG. 5 is an enlarged rear elevational view thereof; and FIG. 6 is an enlarged fragmentary perspective view thereof.

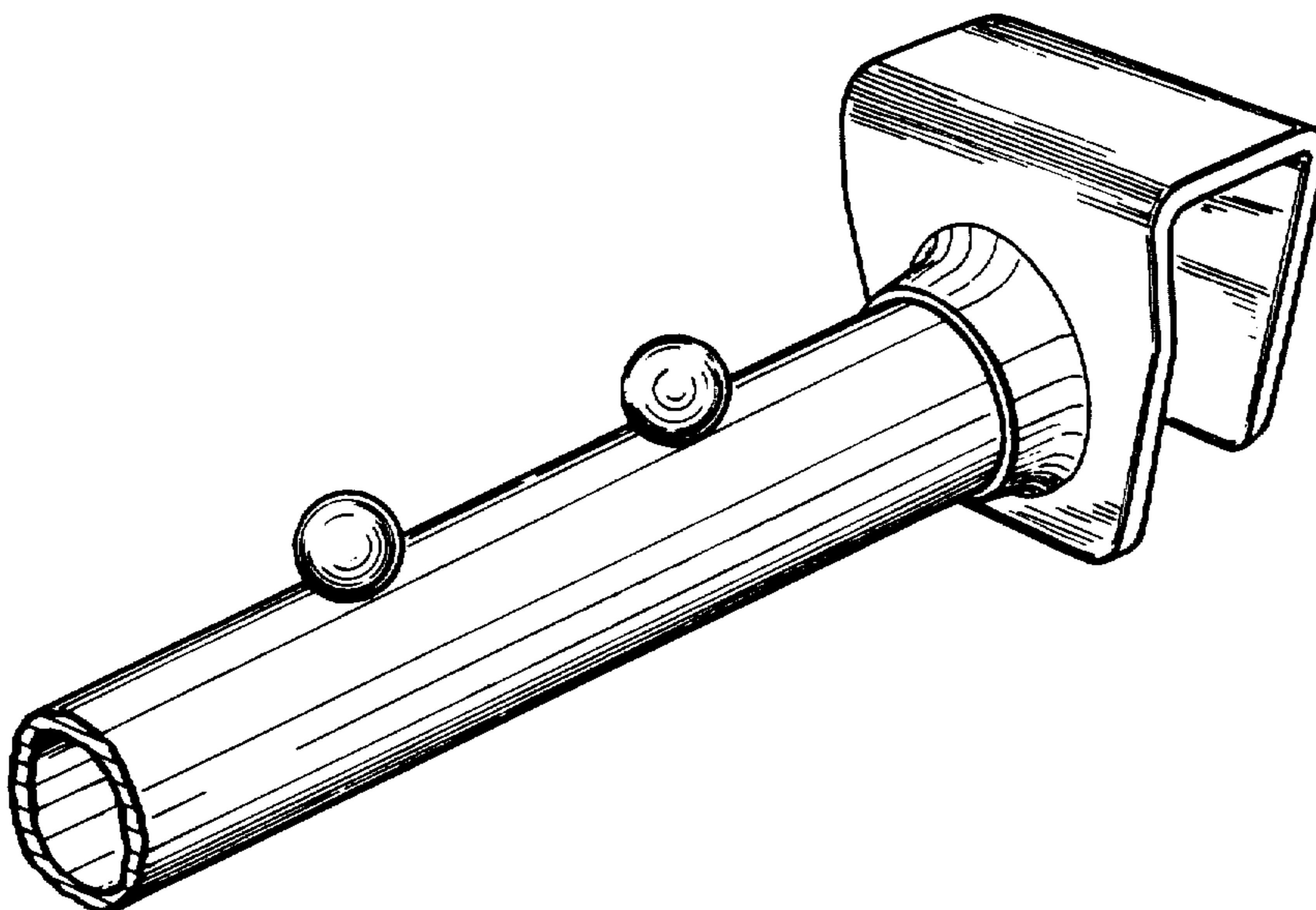
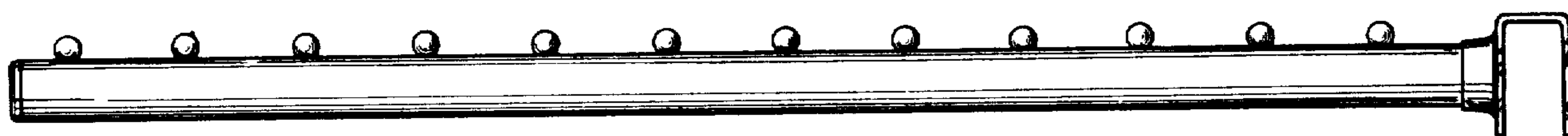

*FIG. 1*

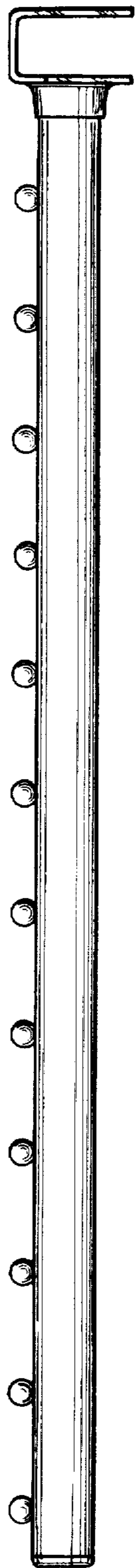

*FIG. 2*

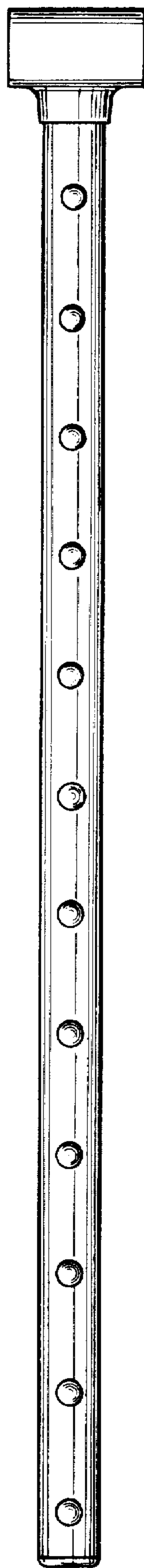

*FIG. 3*

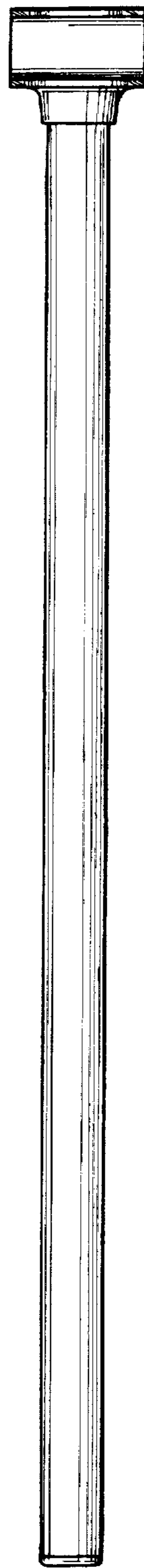

*FIG. 4*

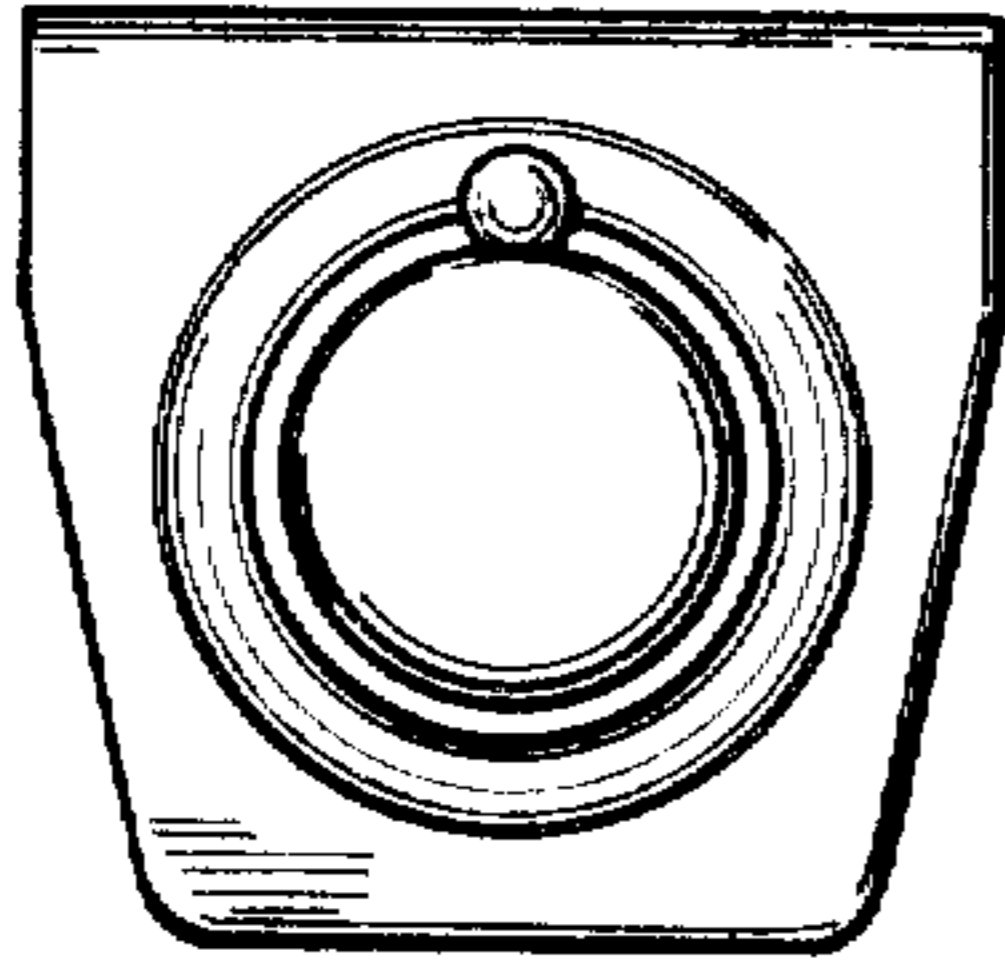

*FIG. 5*

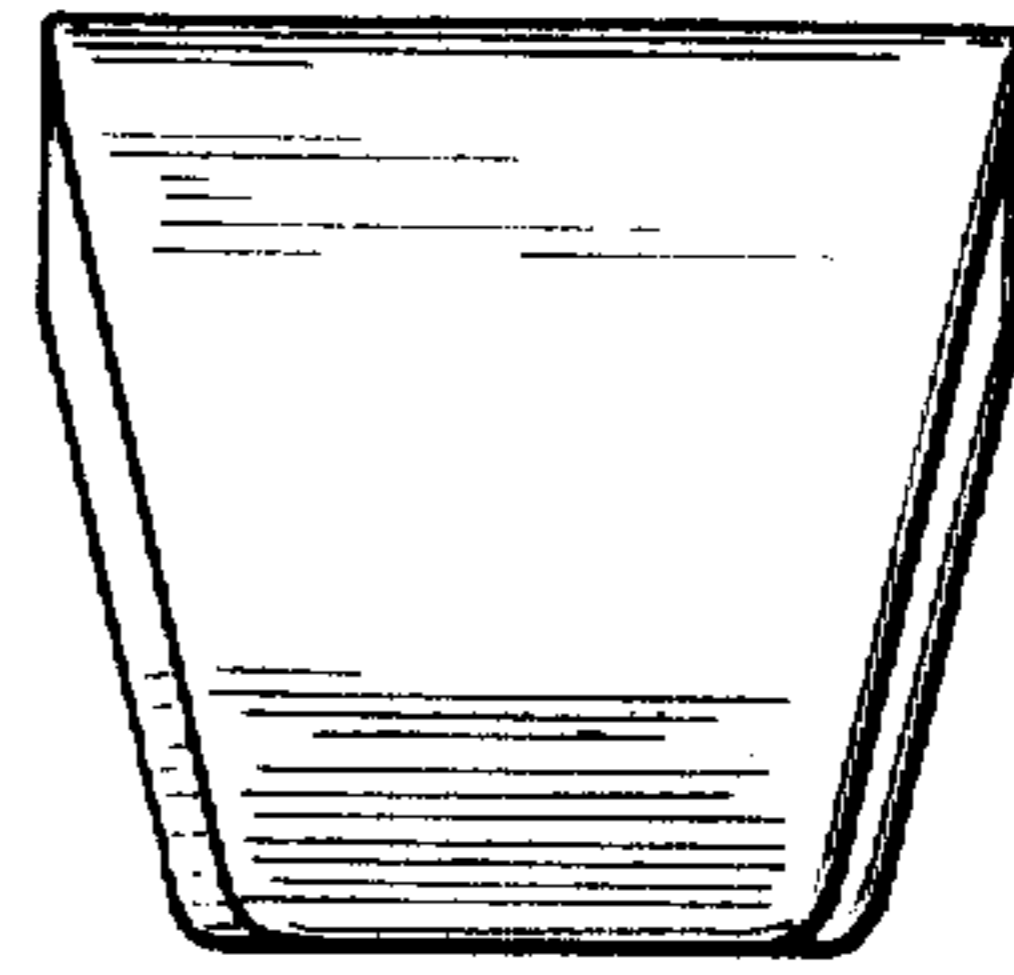

*FIG. 6*

