

[54] CLOTHES HAMPER

[75] Inventor: **Barbara Adler Katzander**, New York, NY

[73] Assignee: **Joseph A. Kaplan & Sons, Inc.**, Yonkers, N.Y.

[**] Term: **14 Years**

[21] Appl. No.: **575,816**

[22] Filed: **May 8, 1975**

[51] Int. Cl. **D7-07; D9-04**

[52] U.S. Cl. **D7/163**

[58] Field of Search **D7/163, 189, 191-195; D9/246-248, 230-232; D31/24; 206/361, 362.3; 220/11 T, 83, 334**

[56] **References Cited**

U.S. PATENT DOCUMENTS

D. 55,289	5/1920	Loewenberg	D7/163
D. 75,613	6/1928	Cook	D7/163
D. 158,905	6/1950	Smithson	D7/189
D. 186,692	11/1959	Davis	D7/163

OTHER PUBLICATIONS

Skalny Quality Basket Catalogue, 1966, p. 34, Basket No. 86/250/2B.

Avon Catalogue, Campaign 24, 1970, p. 52, Mail Box Decanter.

Primary Examiner—Susie J. Mercer

Assistant Examiner—Catherine Kemper

Attorney, Agent, or Firm—Alan H. Levine

[57] **CLAIM**

The ornamental design for a clothes hamper, substantially as shown and described.

DESCRIPTION

FIG. 1 is a front elevational view of a clothes hamper showing my new design;

FIG. 2 is a top plan view thereof;

FIG. 3 is a rear elevational view thereof;

FIG. 4 is a bottom plan view thereof;

FIG. 5 is a right-side elevational view thereof; and

FIG. 6 is a left side, top, and front perspective view thereof.

The wicker pattern which is shown fragmentarily in all views is understood to repeat throughout the indicated areas.

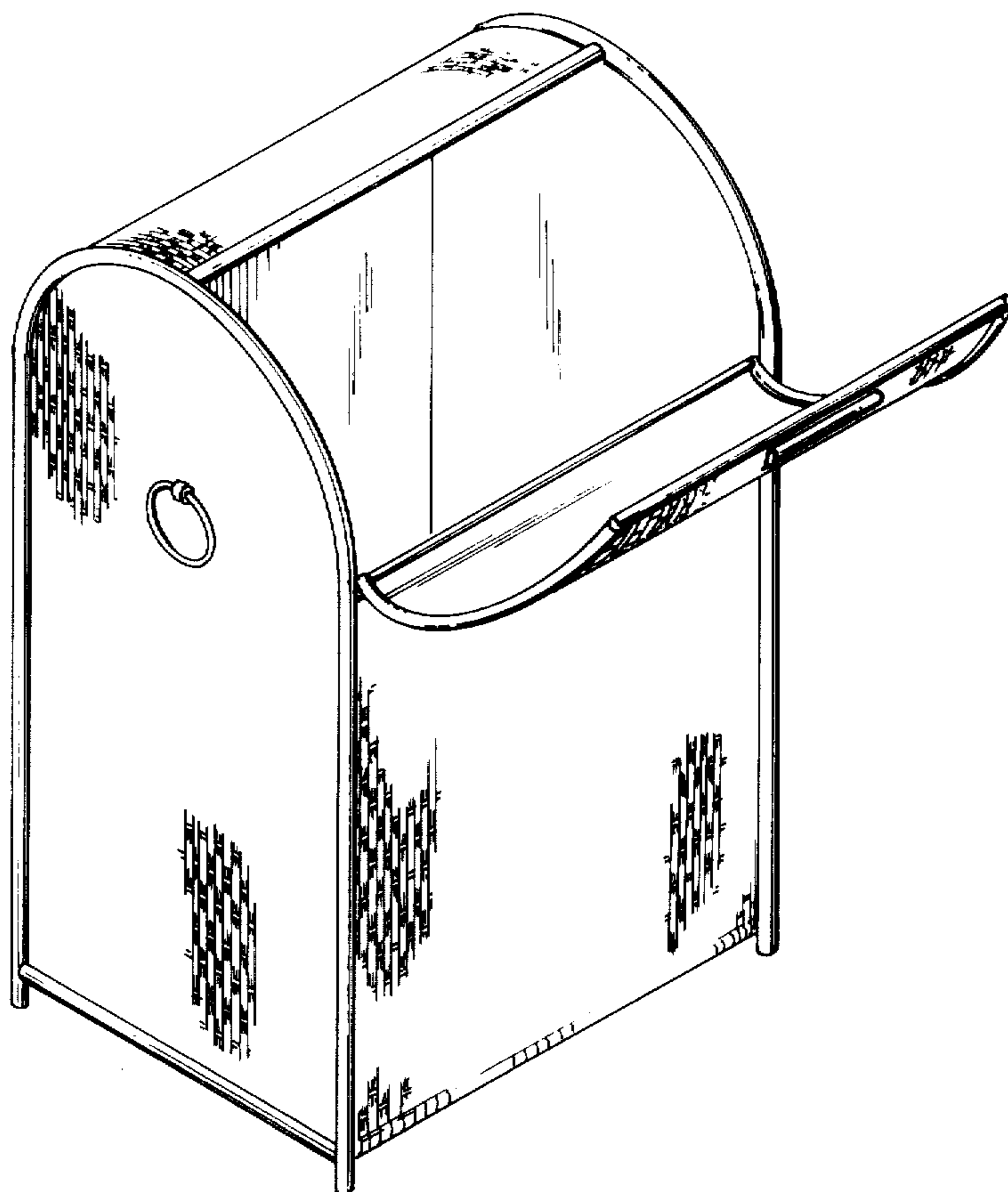

FIG. 1

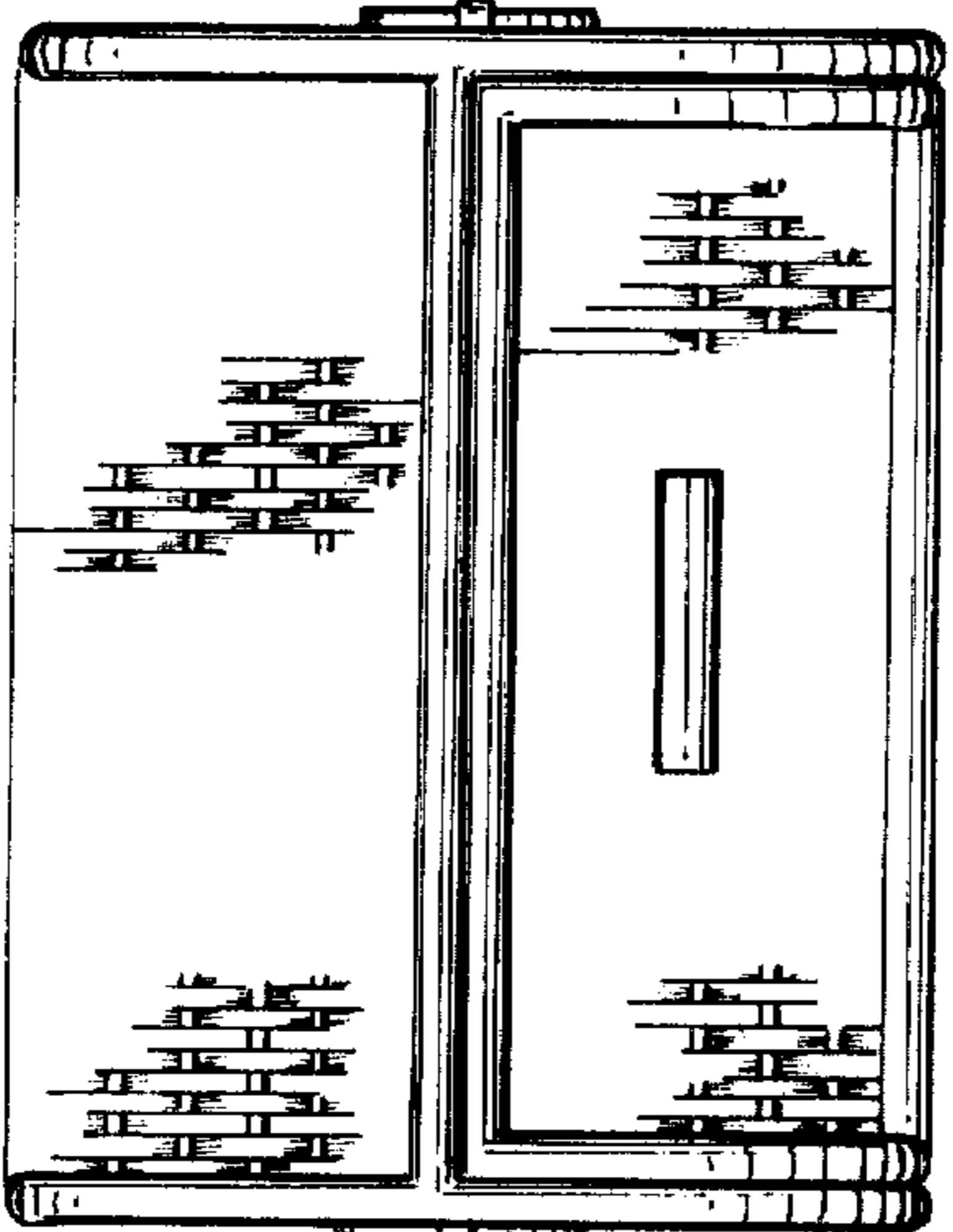
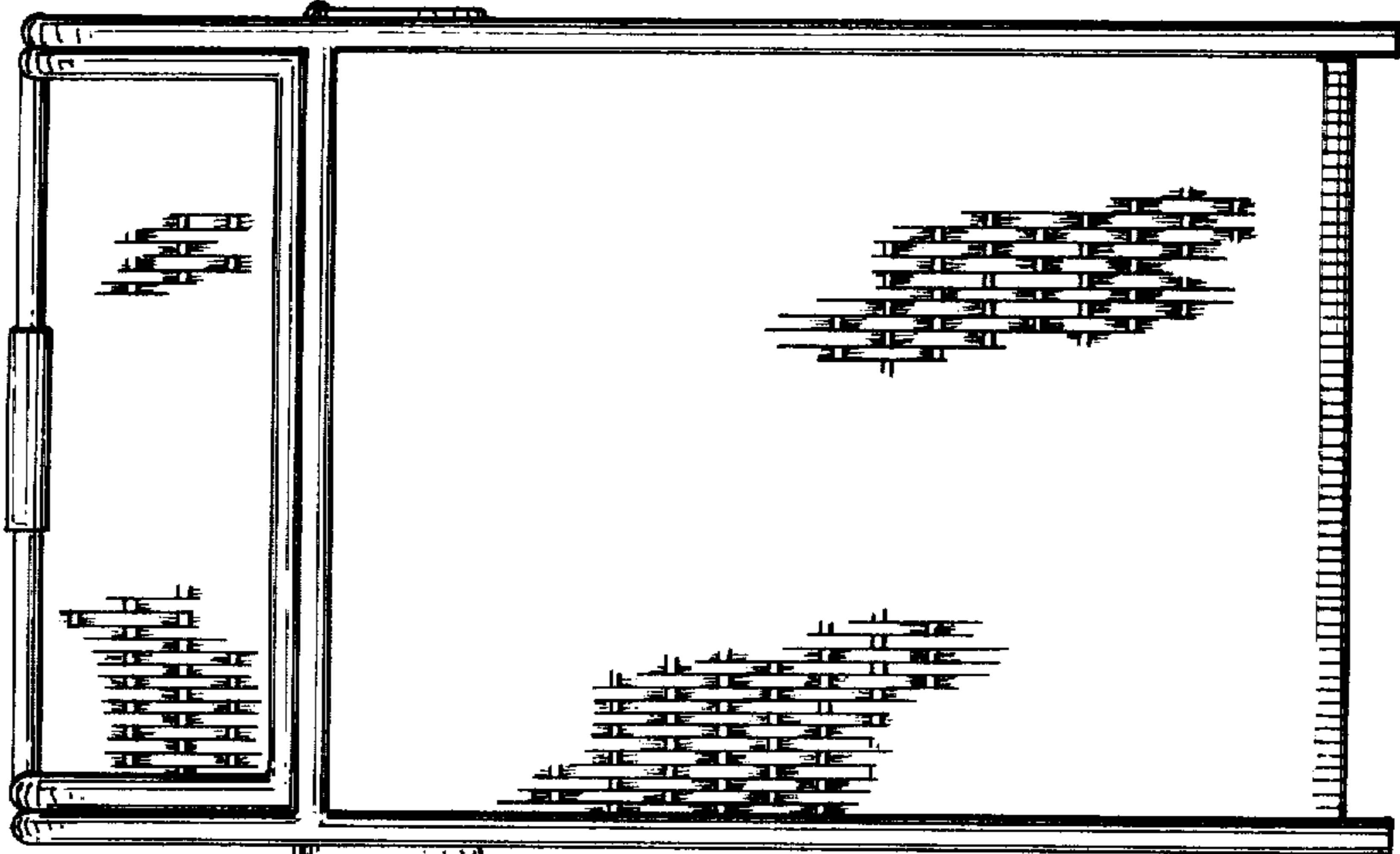

FIG. 2

FIG. 3

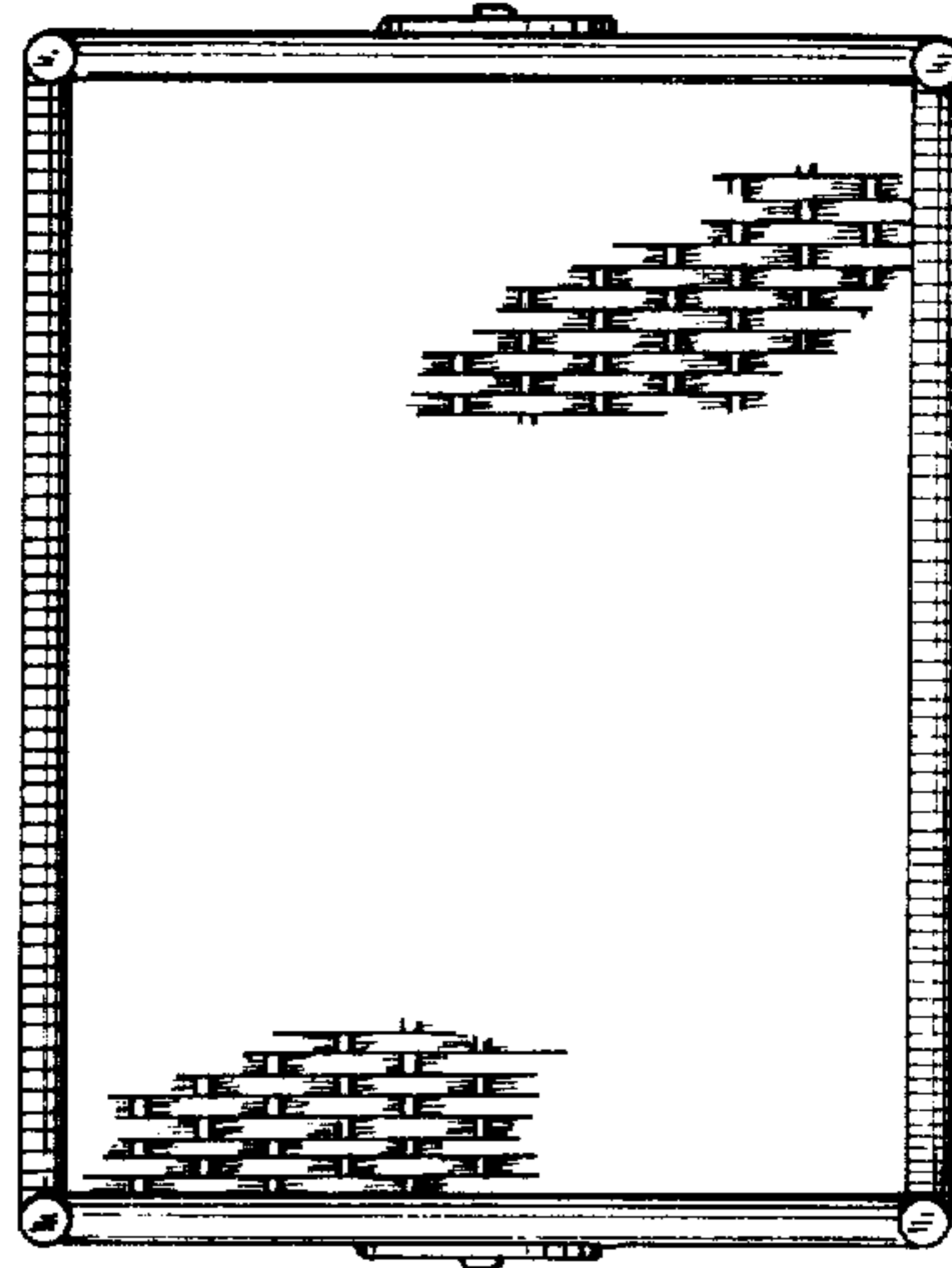
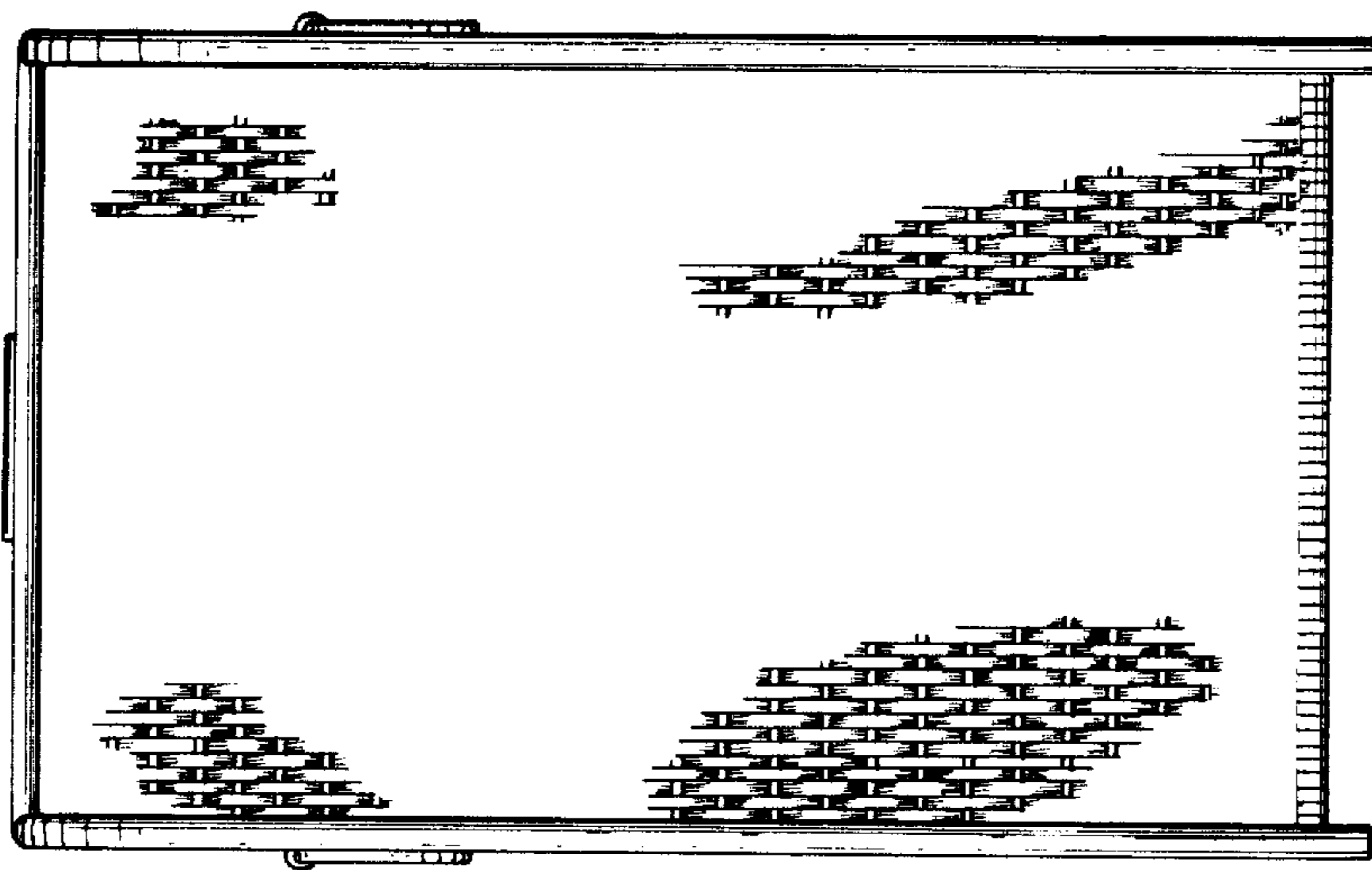

FIG. 4

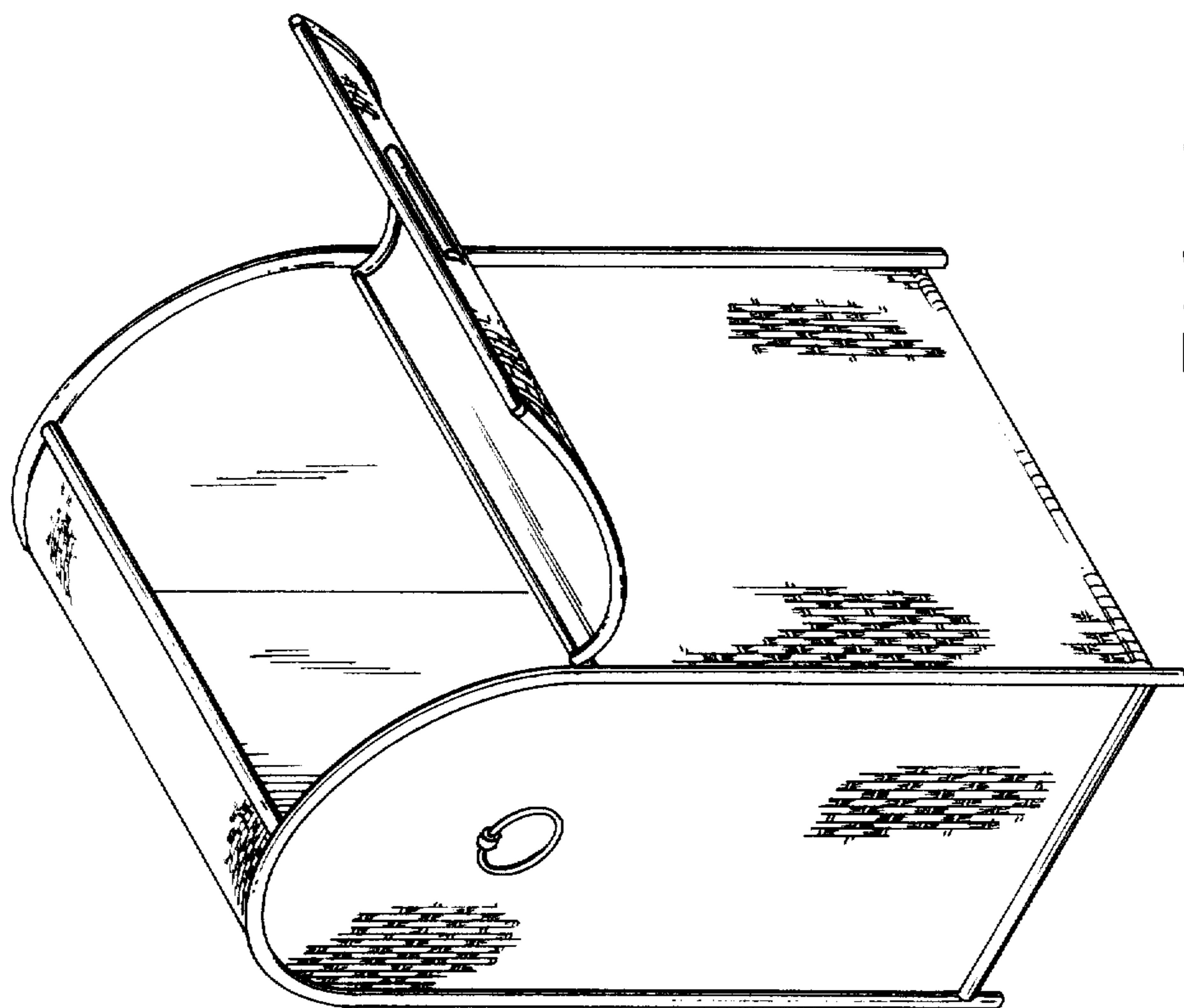

FIG. 5

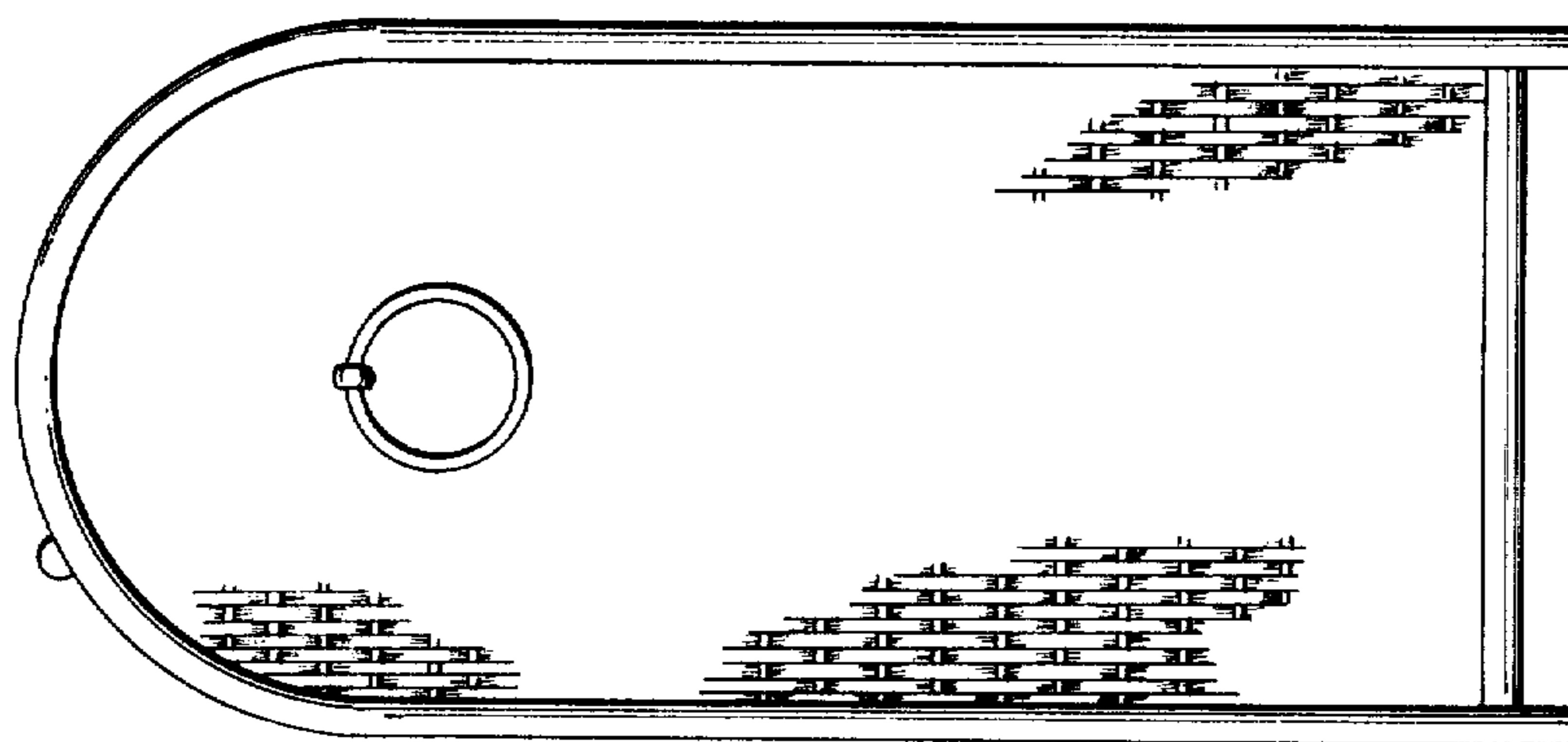

FIG. 6