

[54] GOLF CLUB HEAD

[76] Inventor: Marshall D. Hall, 2075 Hammock Place, Sarasota, Fla. 33580

[\*\*] Term: 14 Years

[21] Appl. No.: 581,815

[22] Filed: May 29, 1975

[51] Int. Cl. .... D21-02

[52] U.S. Cl. .... D34/5 GH

[58] Field of Search ..... D34/5 GH, 5 GC; 273/167-175, 164

[56] References Cited

U.S. PATENT DOCUMENTS

- D. 179,819 3/1957 Penna ..... D34/5 GH
- D. 203,936 3/1966 Long ..... D34/5 GH

Primary Examiner—Melvin B. Feifer  
Attorney, Agent, or Firm—James E. Nilles

[57] CLAIM

The ornamental design for a golf club head, as shown and described.

DESCRIPTION

FIG. 1 is a perspective view of the face of the golf club head showing my new design;  
 FIG. 2 is a perspective view of the back of the golf club head;  
 FIG. 3 is a rear elevation view thereof;  
 FIG. 4 is a top plan view thereof;  
 FIG. 5 is a bottom plan view thereof;  
 FIG. 6 is an end elevation view taken from the left of FIG. 3;  
 FIG. 7 is an end elevation view taken from the right of FIG. 3; and  
 FIG. 8 is a front elevation view thereof;  
 The figures are shown fragmentarily, with the exception of FIG. 2, for convenience of illustration.

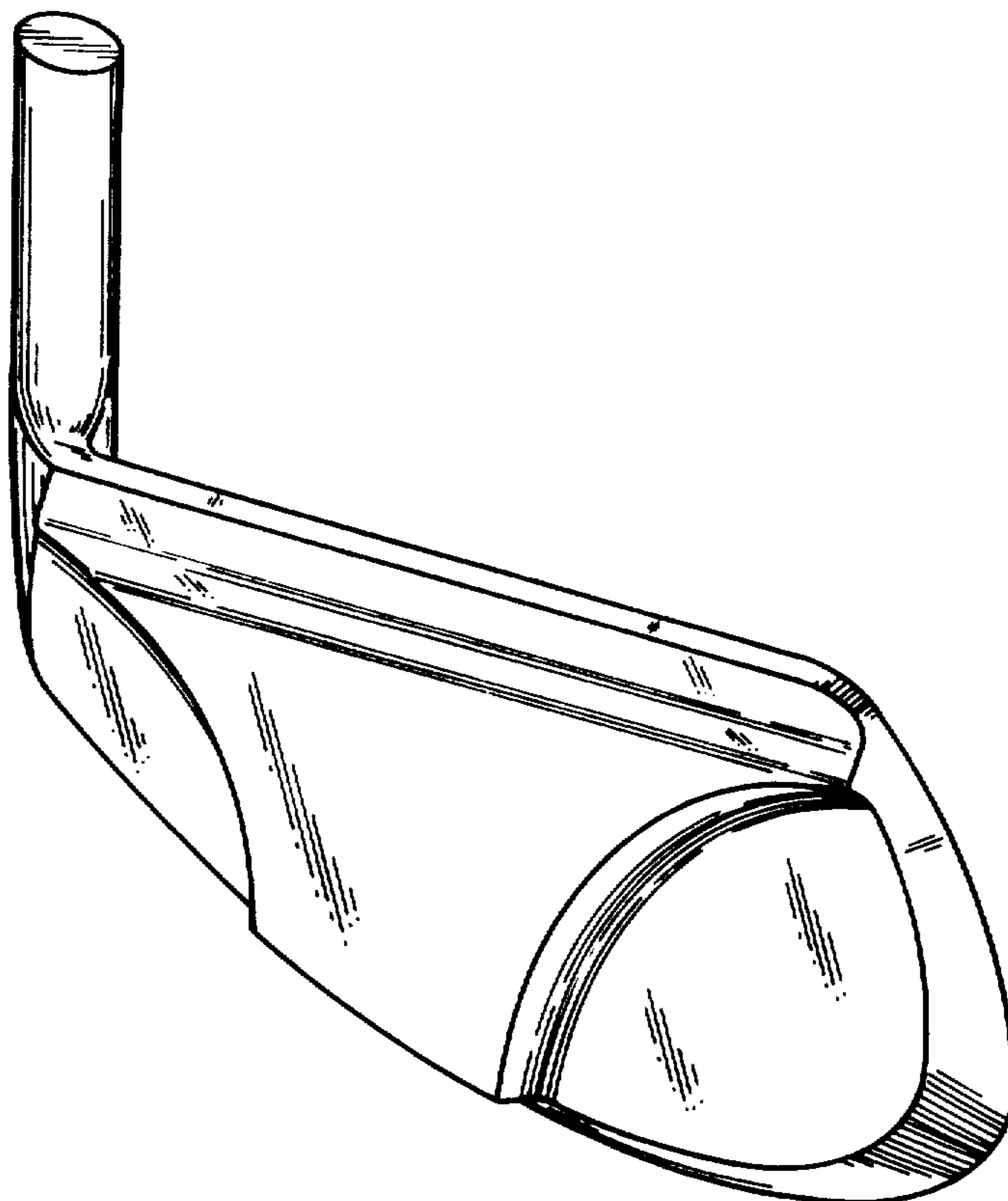

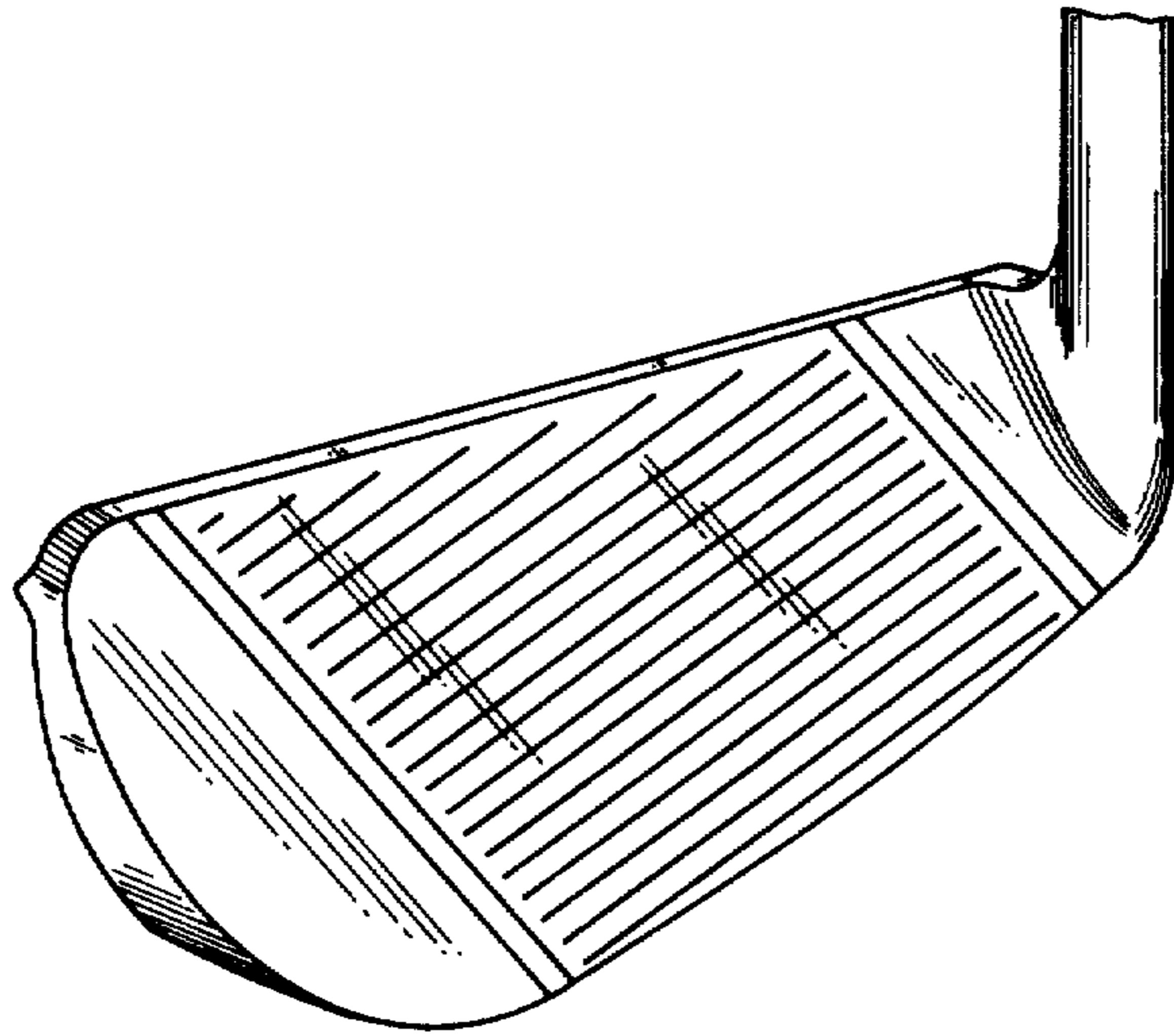

FIG. 1

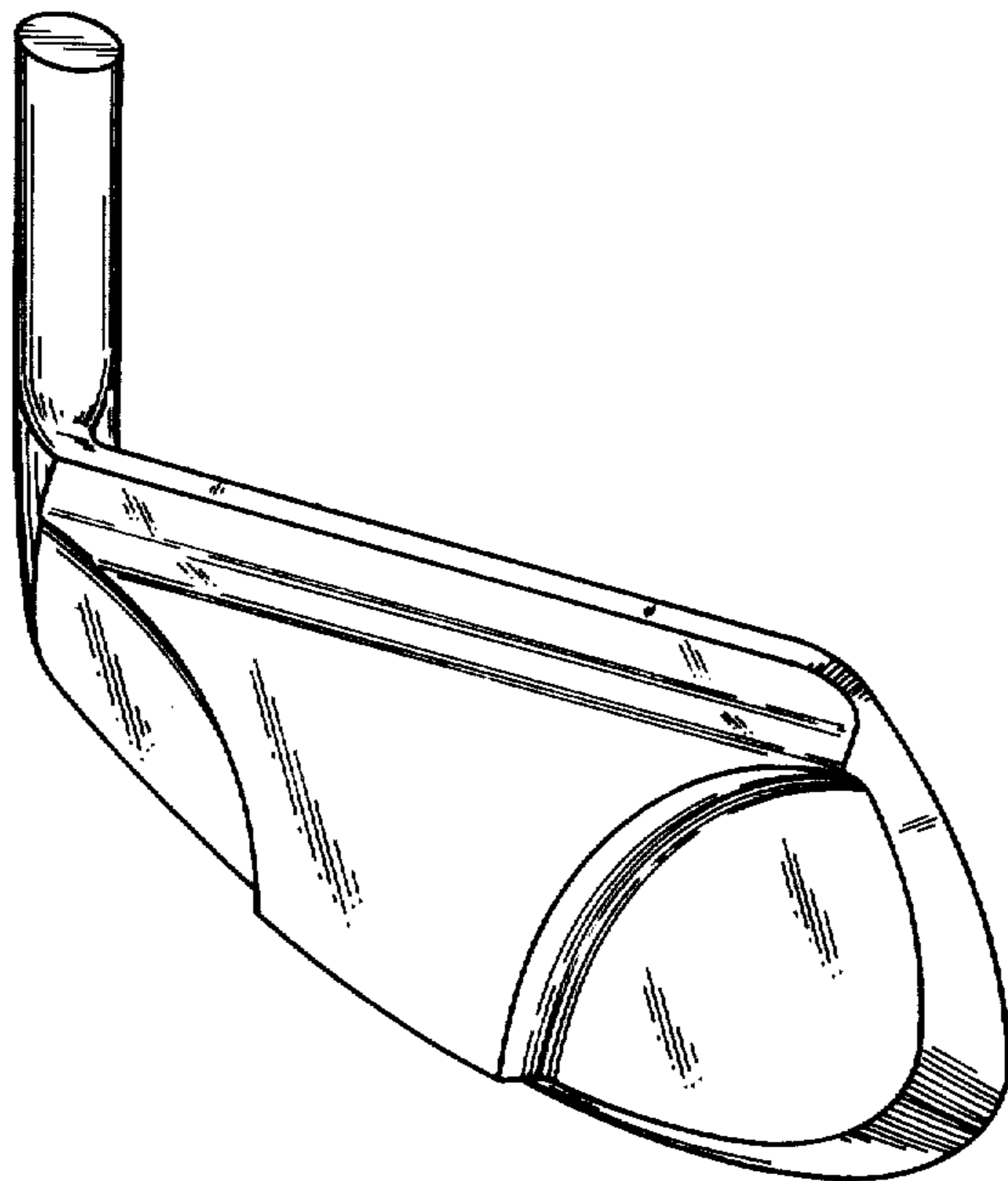

FIG. 2

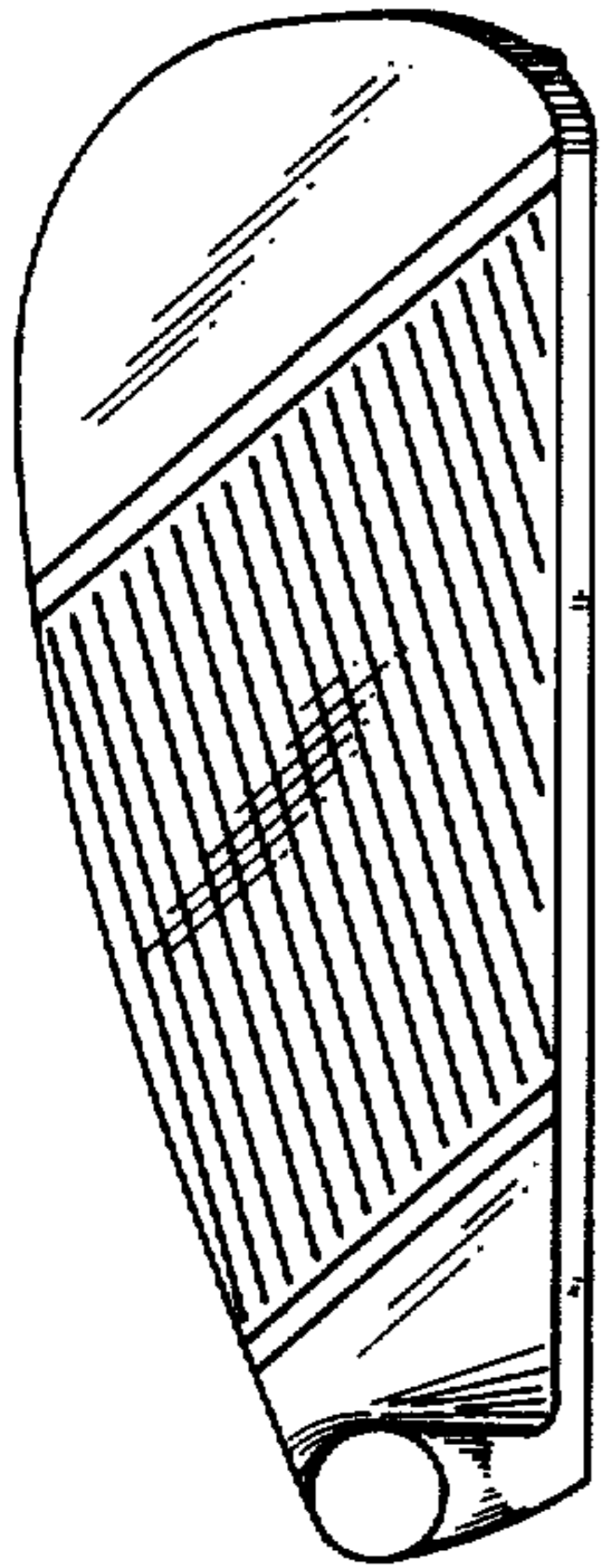

FIG. 4

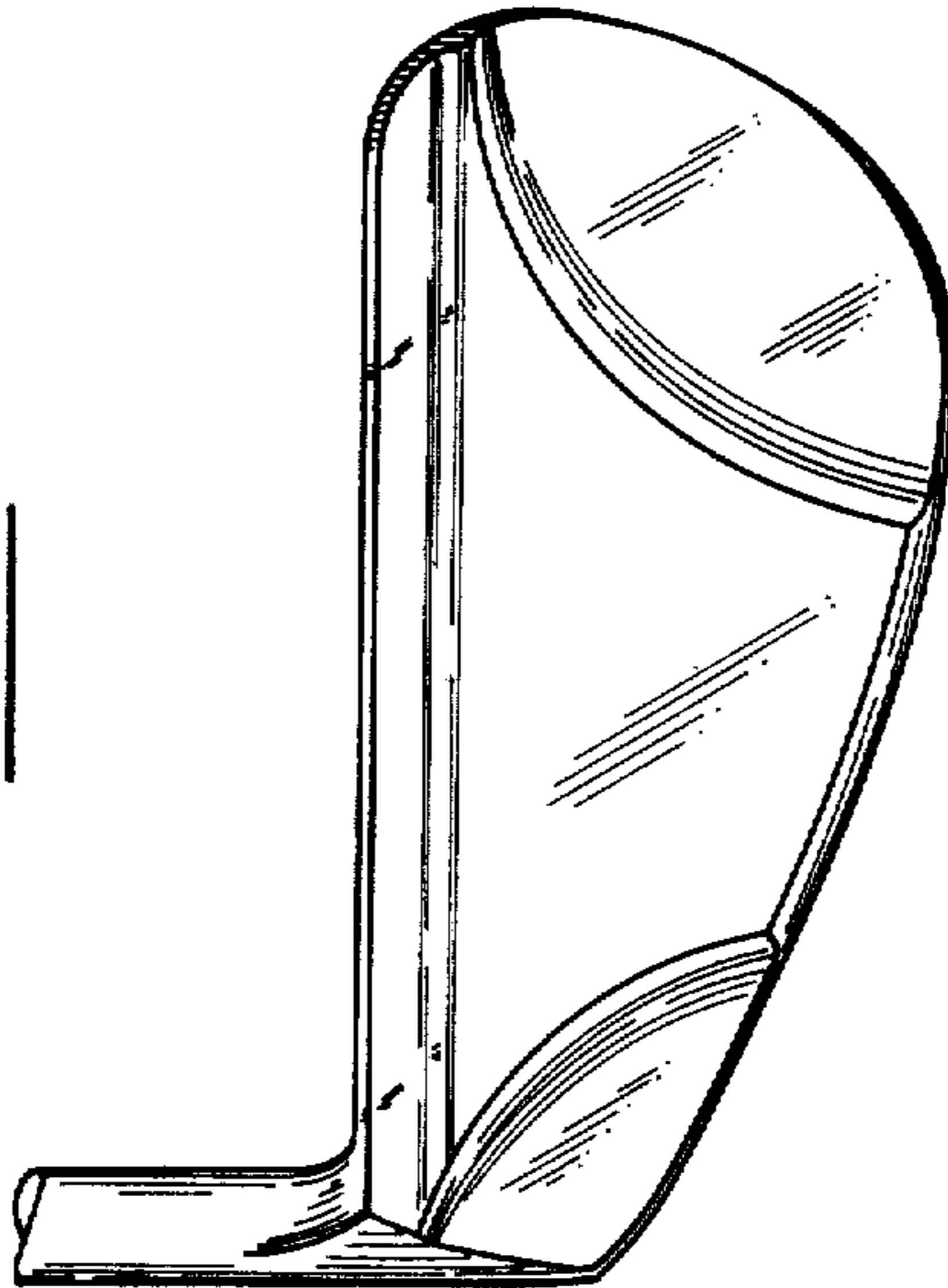

FIG. 3

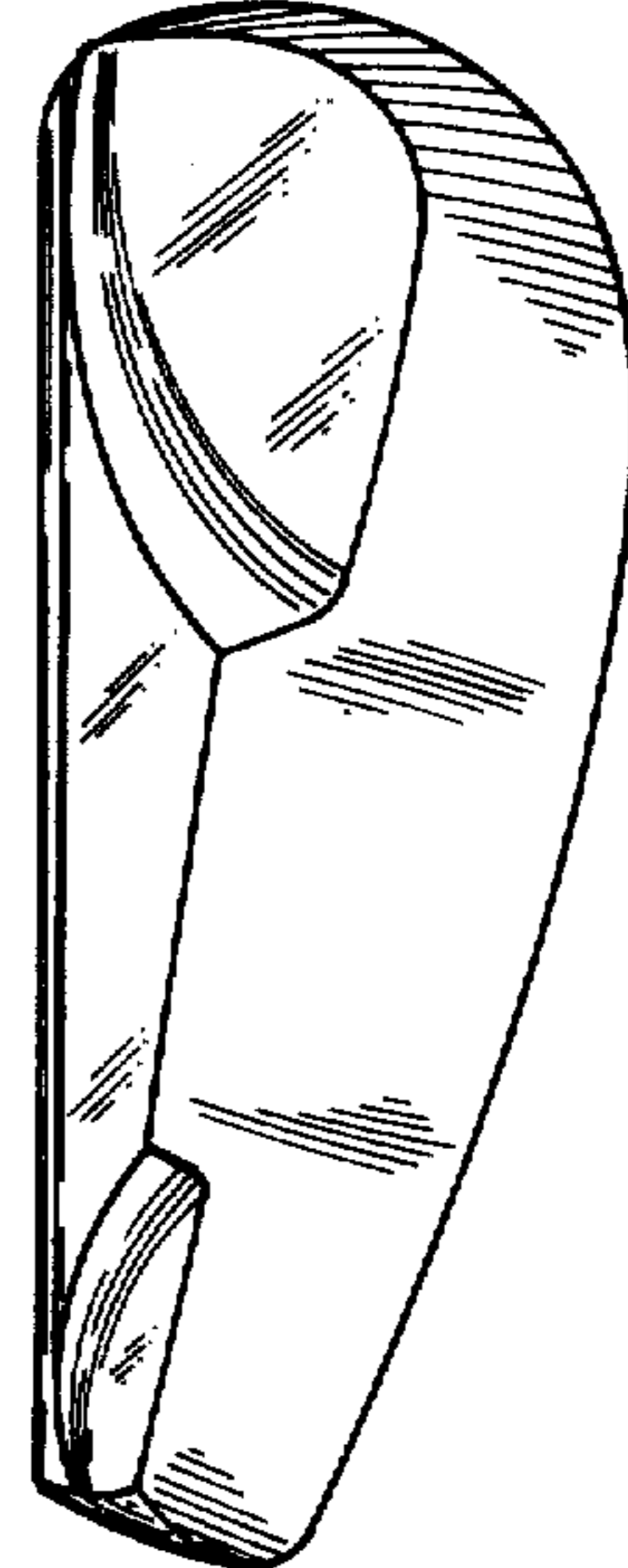

FIG. 5

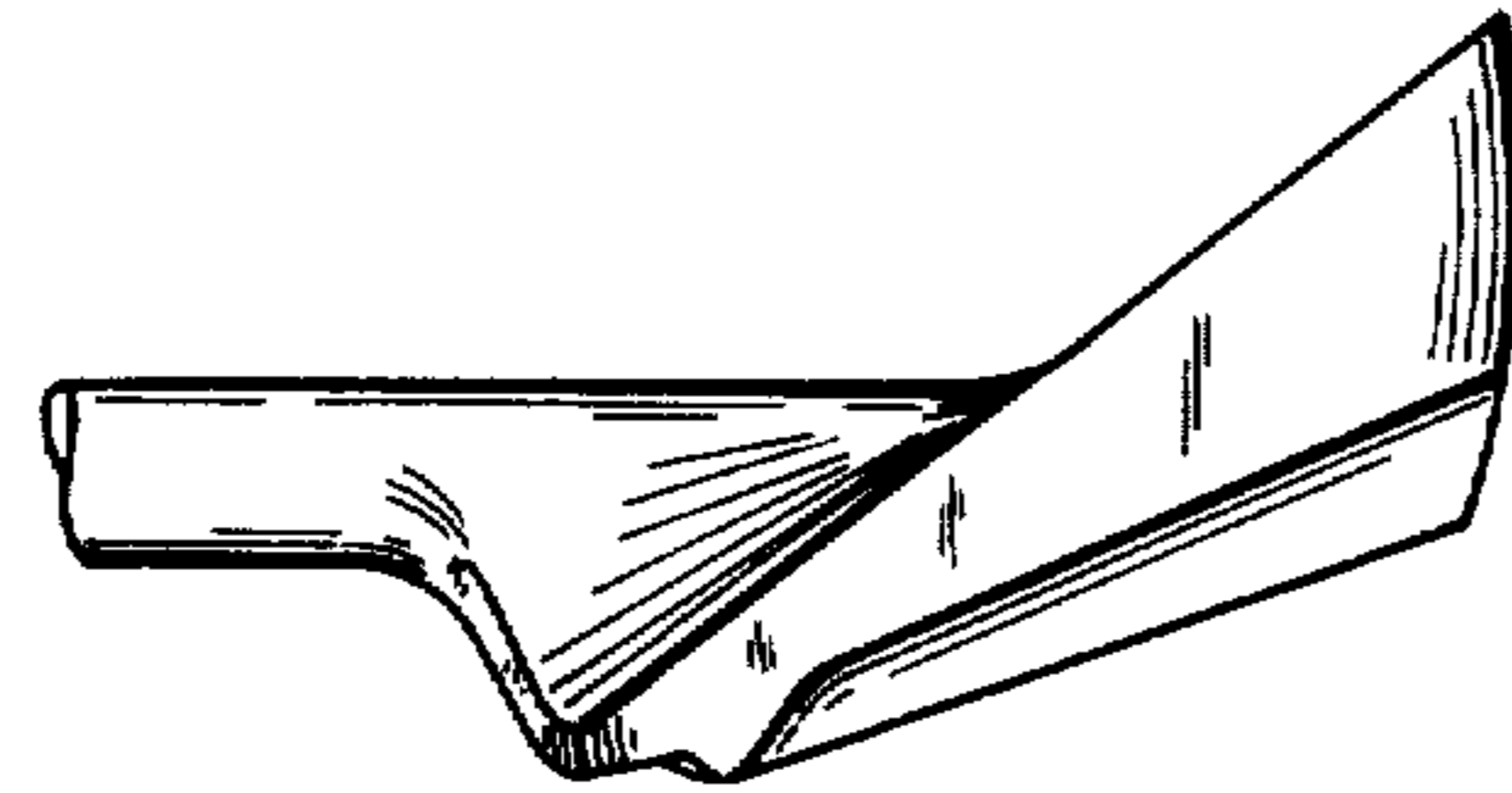

FIG. 7

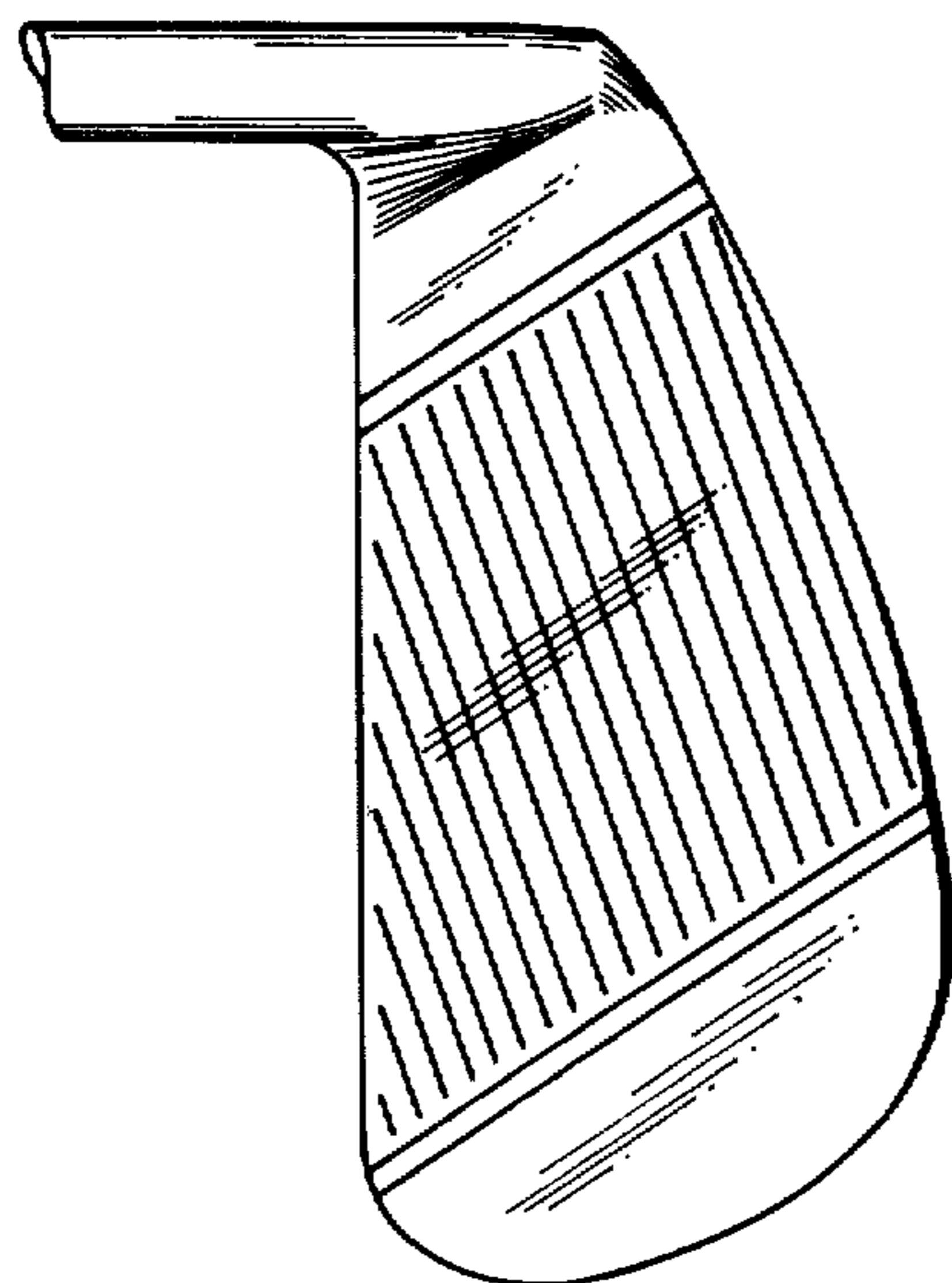

FIG. 8

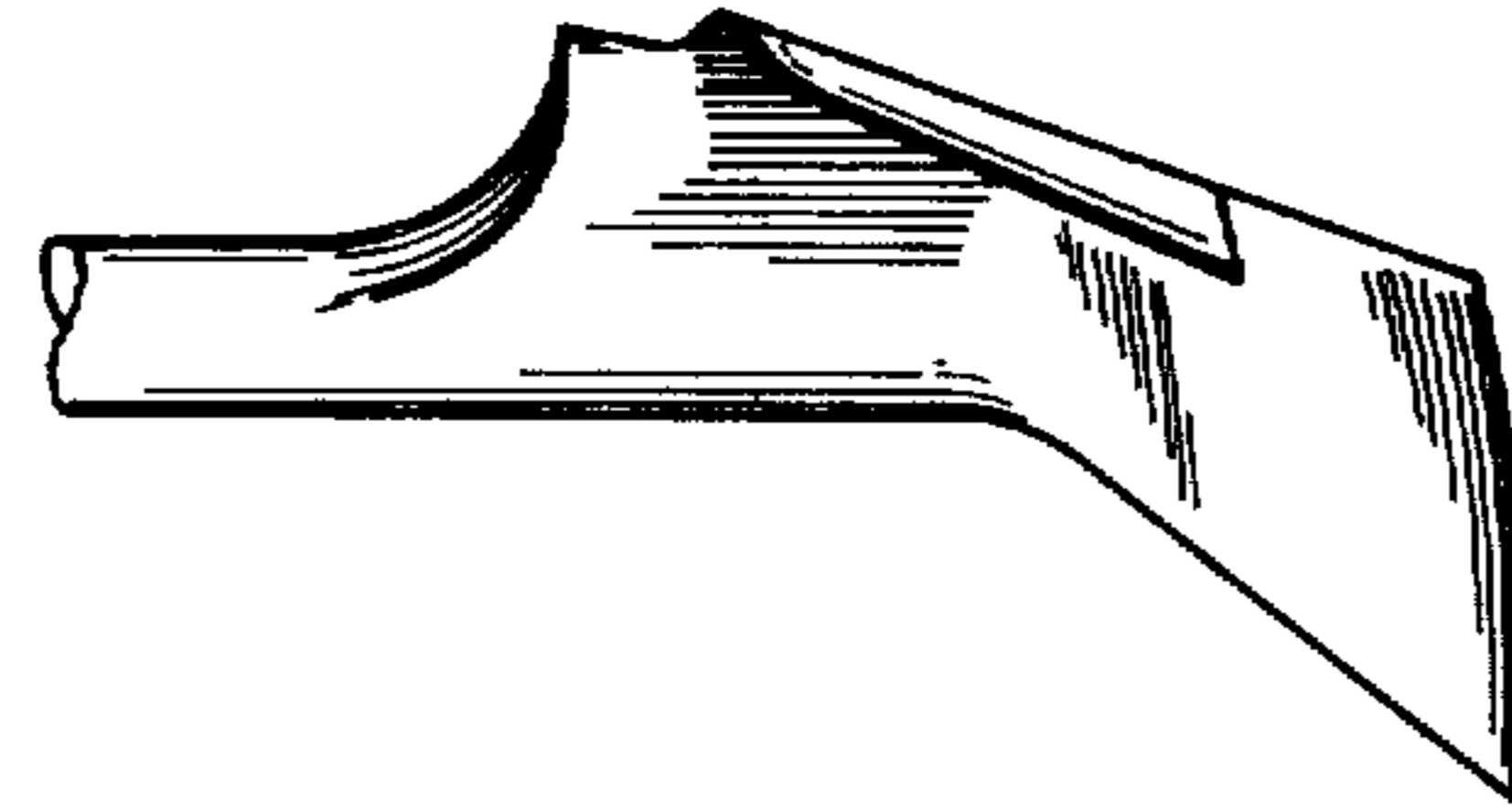

FIG. 6