

[54] BATHING POOL

[75] Inventor: **George S. Gruber**, Hidden Hills, Calif.

[73] Assignee: **Dimensionetix, Inc.**, North Hollywood, Calif.

[\*\*] Term: **14 Years**

[21] Appl. No.: **690,987**

[22] Filed: **May 28, 1976**

[51] Int. Cl. .... **D23-02**

[52] U.S. Cl. .... **D23/55**

[58] Field of Search ..... D23/48-50, D23/55-57; 4/1-5, 10, 146, 148, 152-155, 173, 178, 180, 185 S, 185 AB, 185 L

[56] **References Cited**

**U.S. PATENT DOCUMENTS**

2,081,728	5/1937	Bassett	4/173
2,566,495	9/1951	Miyakawa	4/173
3,496,577	2/1970	Saldana	4/185 R X
D. 214,270	5/1969	Bonsack	D23/55
D. 226,607	4/1973	Lawrence	D23/55

D. 229,186	11/1973	Mollerstedt	D23/55
D. 230,021	1/1974	Primault	D23/55
D. 237,616	11/1975	Gordon	D23/55
D. 238,071	12/1975	Granger	D23/55
D. 238,072	12/1975	Granger	D23/55
D. 238,074	12/1975	Gruber	D23/55

*Primary Examiner*—James R. Largen  
*Attorney, Agent, or Firm*—Robert E. Geauque

[57] **CLAIM**

The ornamental design for a bathing pool, substantially as shown.

**DESCRIPTION**

FIG. 1 is a top plan view of a bathing pool showing my new design;  
FIG. 2 is a front elevational view thereof;  
FIG. 3 is a rear elevational view thereof;  
FIG. 4 is a left side elevational view thereof;  
FIG. 5 is a right side elevational view thereof;  
FIG. 6 is a cross sectional view taken along line 6-6 of FIG. 1; and  
FIG. 7 is a cross sectional view taken along line 7-7 of FIG. 1.

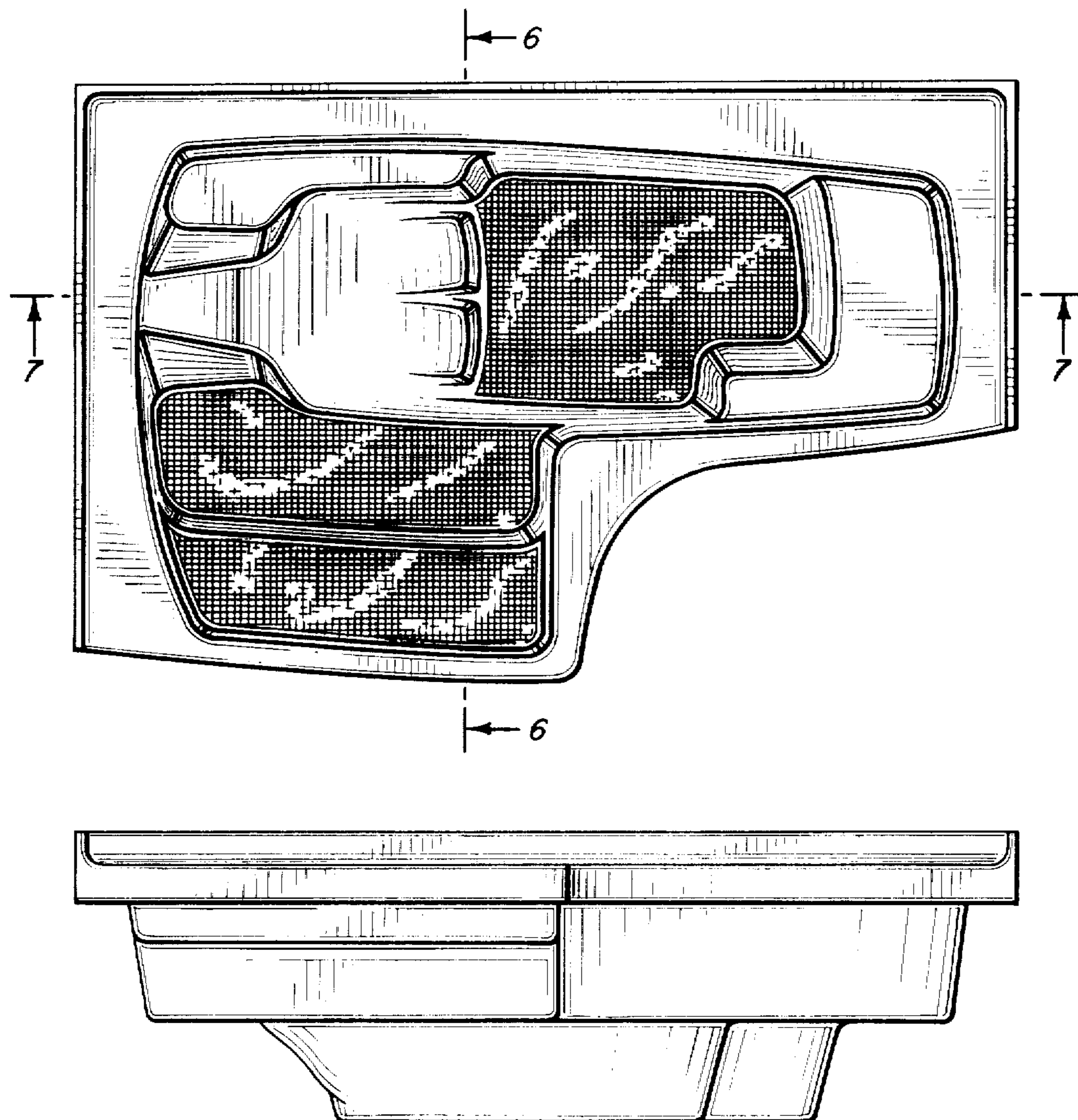

*Fig. 1.*

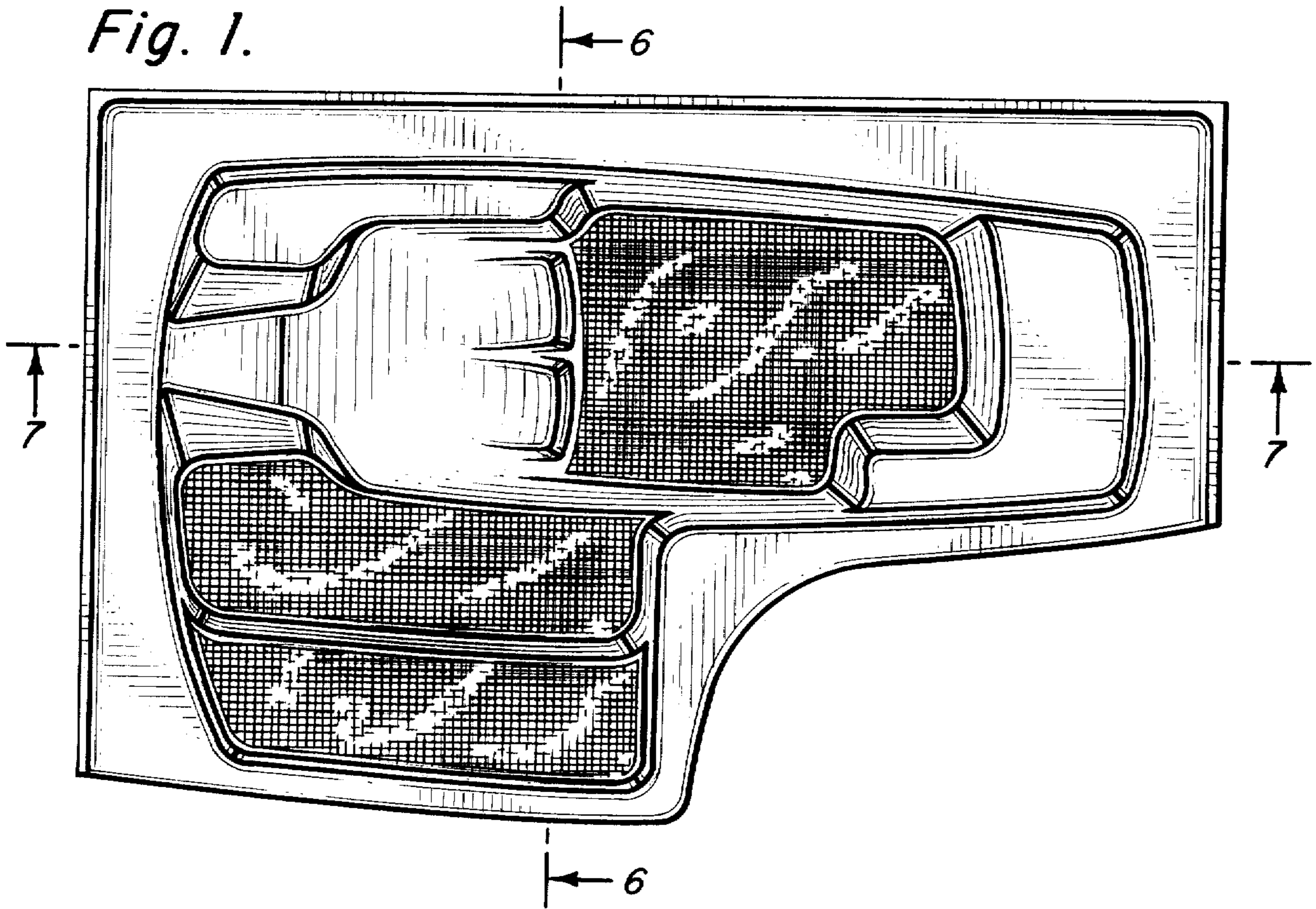

*Fig. 2.*

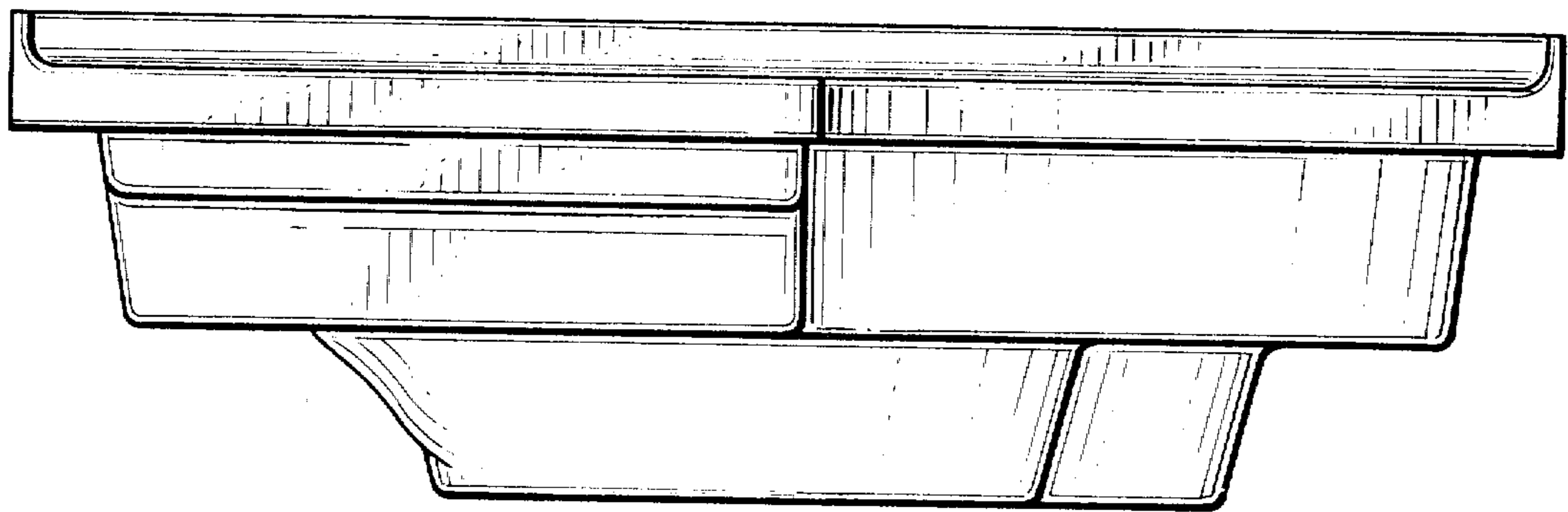

*Fig. 3.*

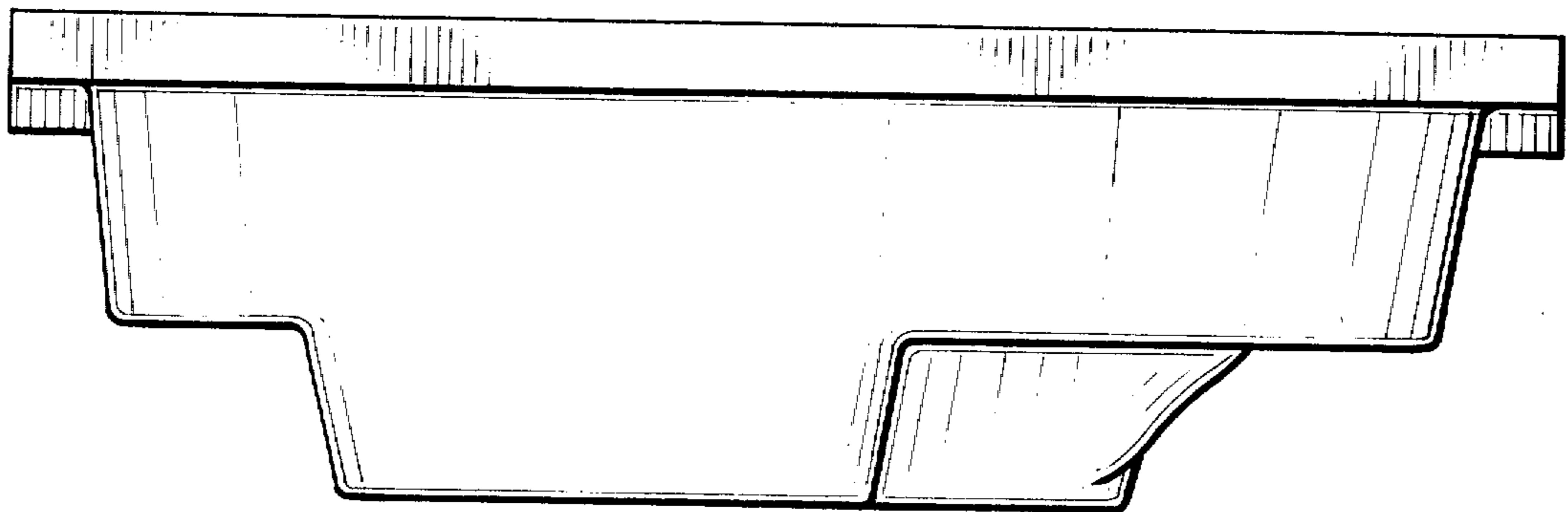

*Fig. 4.*

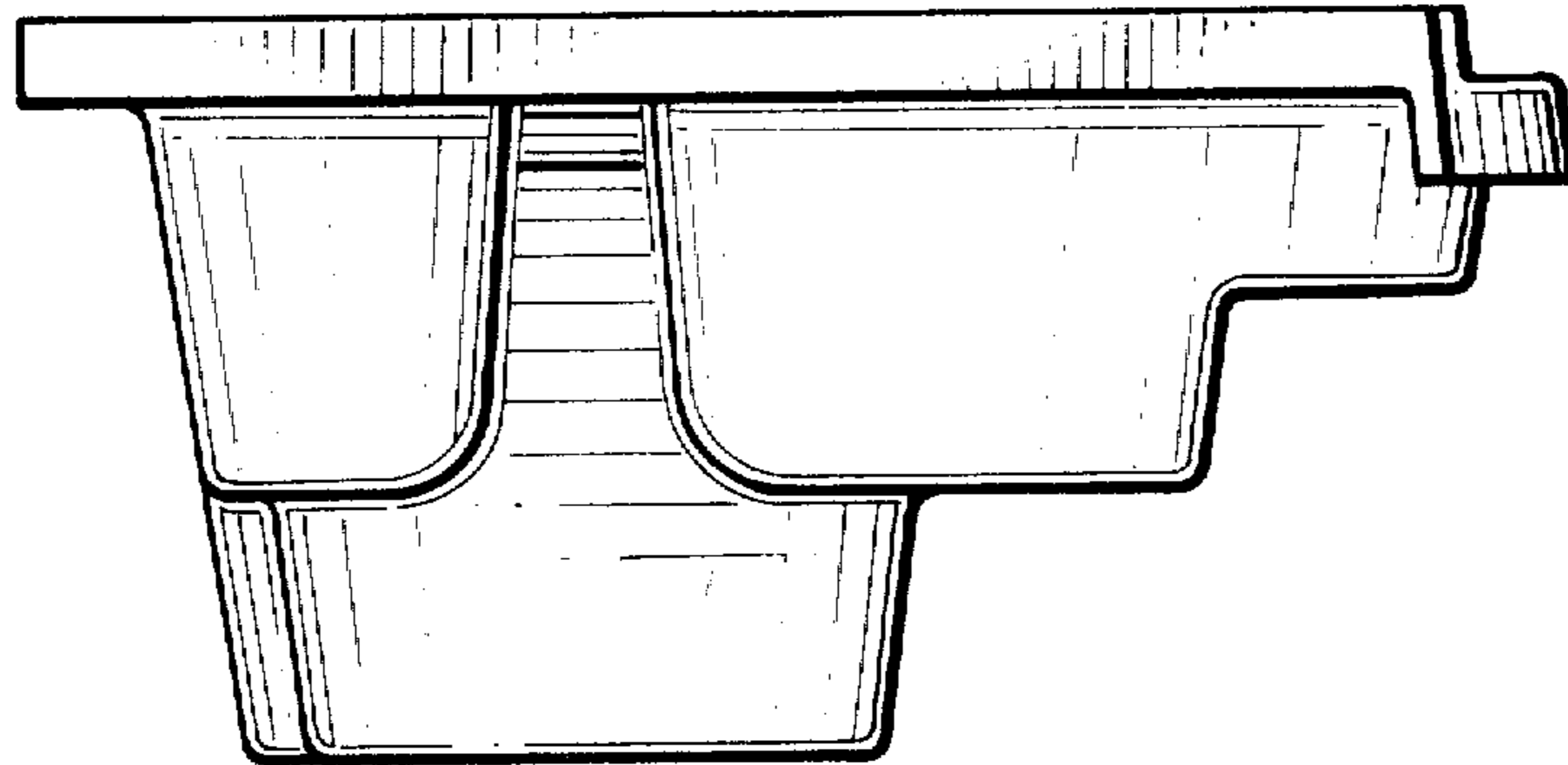

*Fig. 5.*

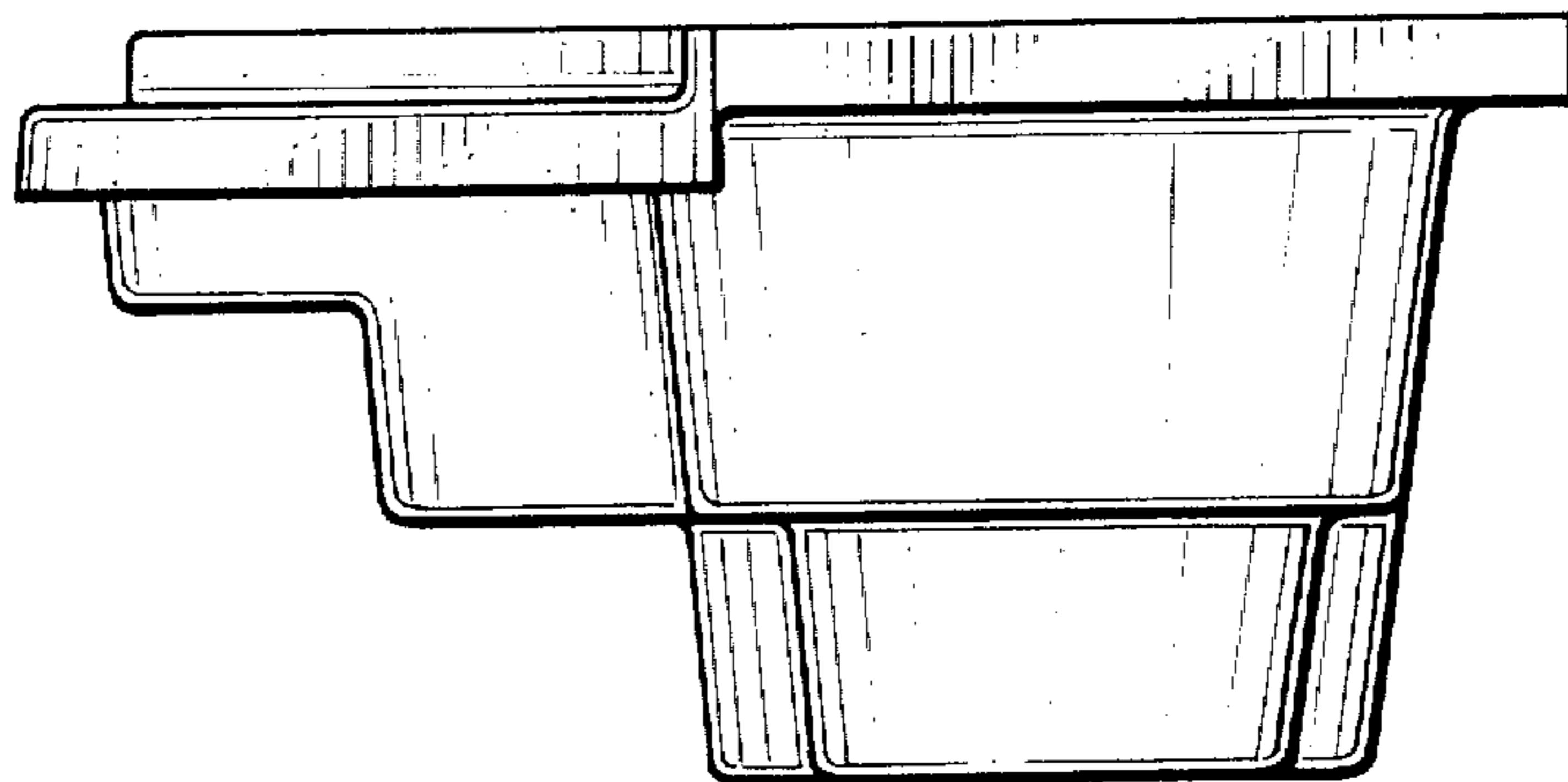

*Fig. 6.*

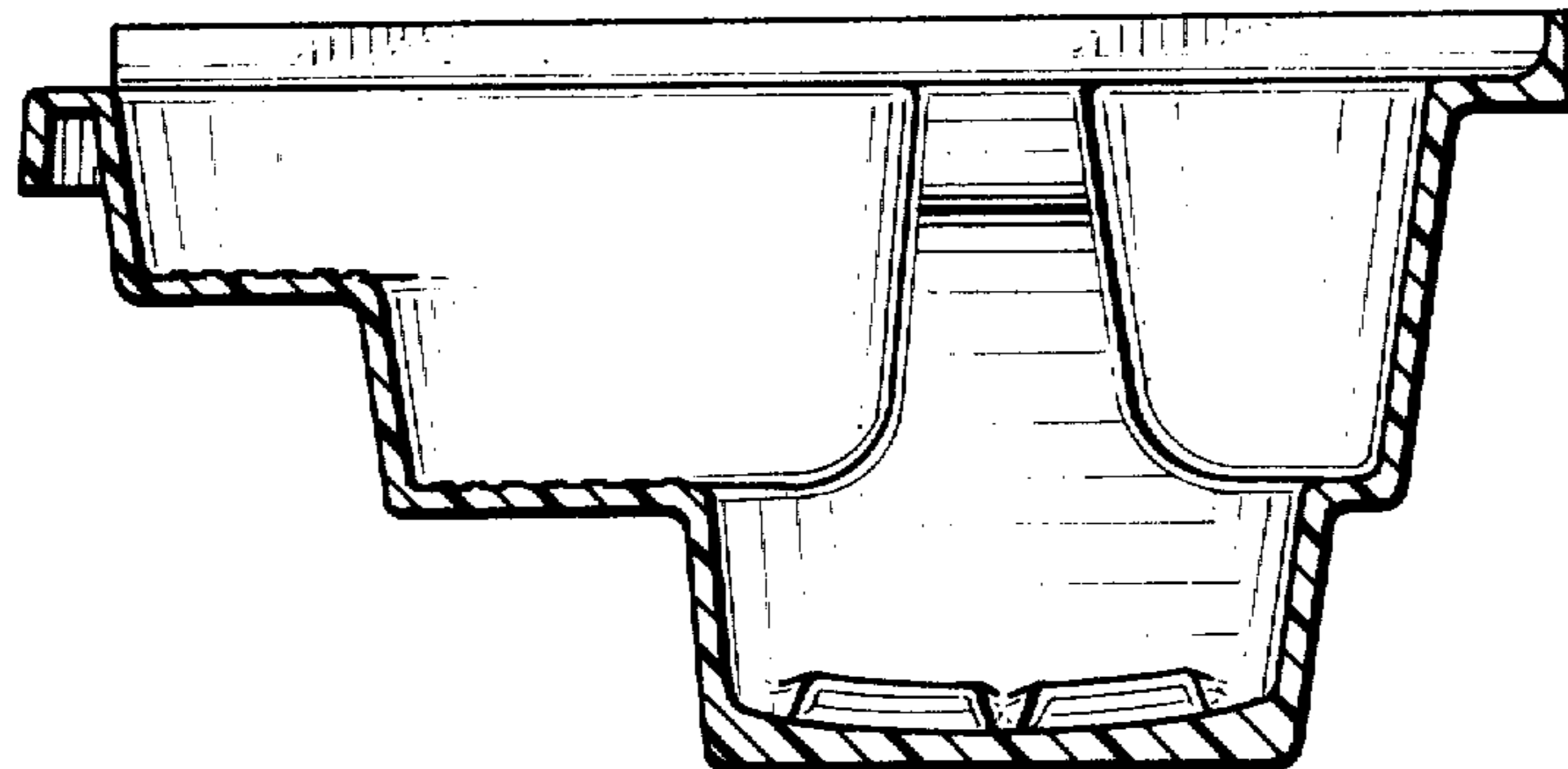

*Fig. 7.*

