

[54] ELECTRIC BATTERY

[75] Inventor: Gordon E. Kaye, Garrison, N.Y.

[73] Assignee: P. R. Mallory & Co., Inc., Indianapolis, Ind.

[**] Term: 14 Years

[21] Appl. No.: 604,287

[22] Filed: Aug. 13, 1975

[51] Int. CL D13-02

[52] U.S. CL D13/8

[58] Field of Search D26/4; 136/166, 173

[56] References Cited

U.S. PATENT DOCUMENTS

2,590,804 3/1952 Vitale 136/166
3,317,349 5/1967 Elliott et al. 136/166 X

FOREIGN PATENT DOCUMENTS

782,524 9/1957 United Kingdom 136/166

OTHER PUBLICATIONS

Radio Shack 1974 Electronics Catalog 1973, p. 116, Battery TRX146B.

Primary Examiner—Susie J. Mercer
Attorney, Agent, or Firm—Charles W. Hoffmann

[57] CLAIM

The ornamental design for an electric battery, substantially as shown and described.

DESCRIPTION

FIG. 1 is a perspective view of an electric battery showing my new design;

FIG. 2 is a front elevation view thereof;

FIG. 3 is a rear elevation view thereof;

FIG. 4 is a top view thereof;

FIG. 5 is a right side elevation view thereof;

FIG. 6 is a bottom view thereof; and

FIG. 7 is a left side elevation view thereof.

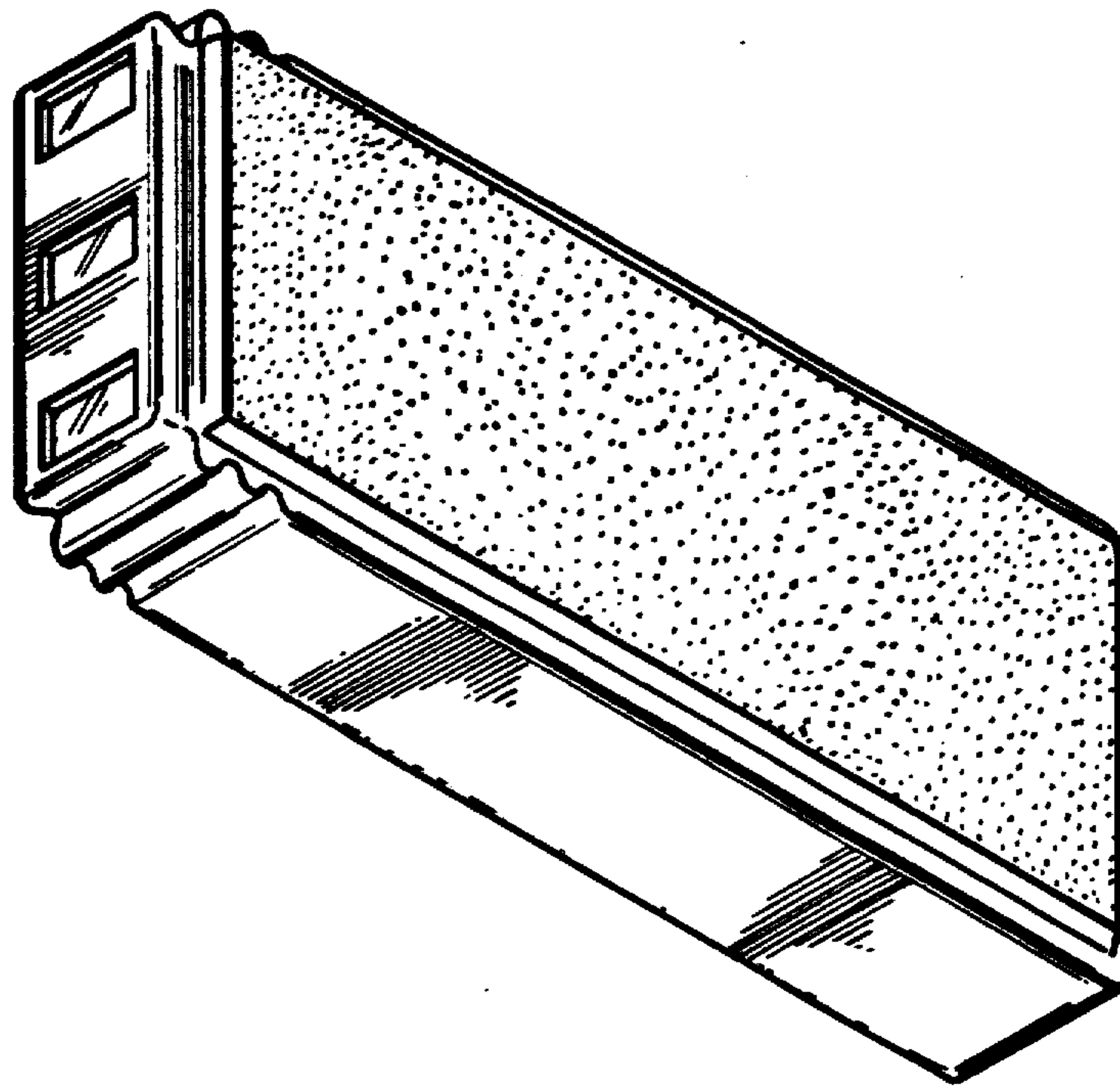

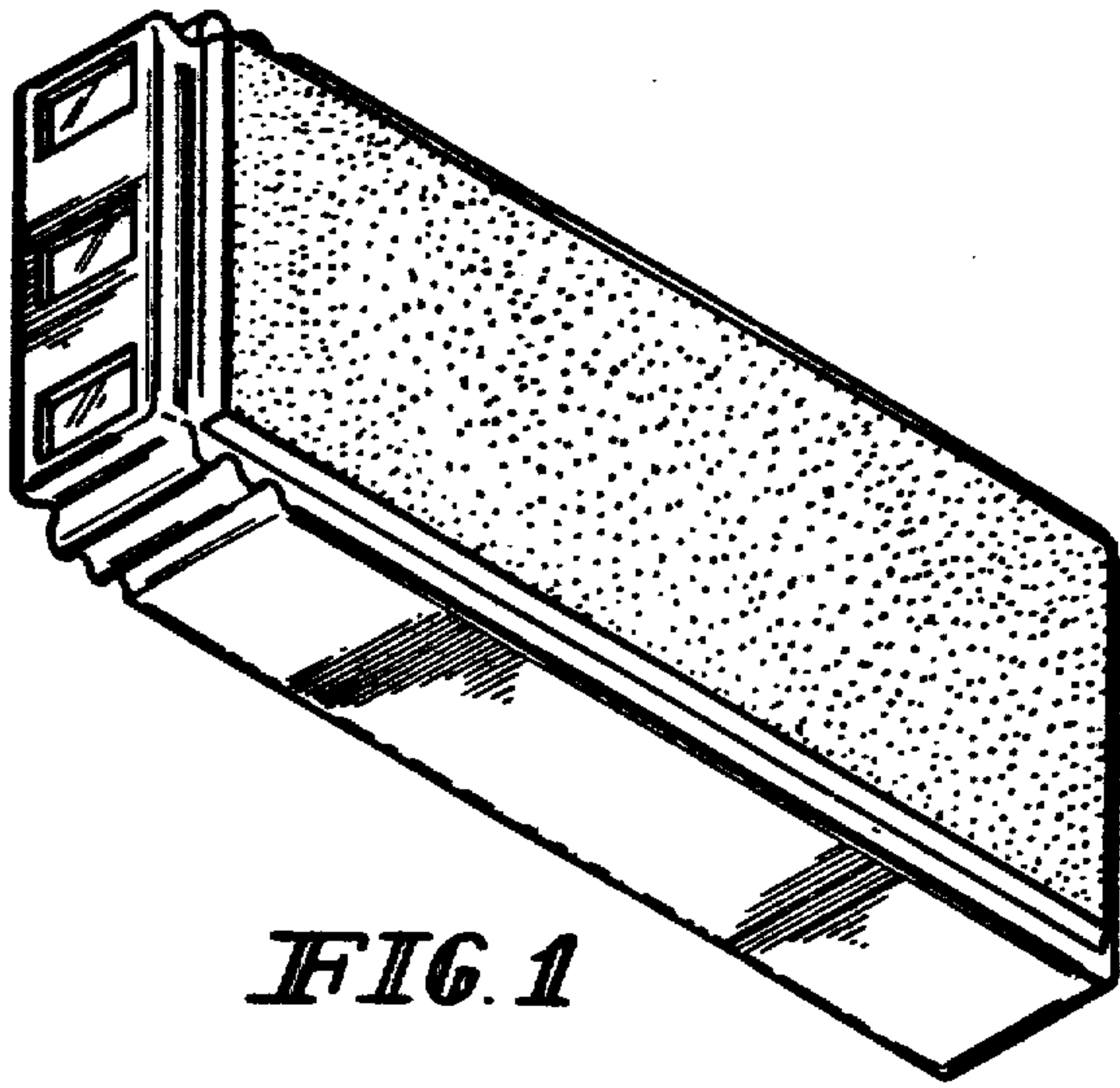

FIG. 1

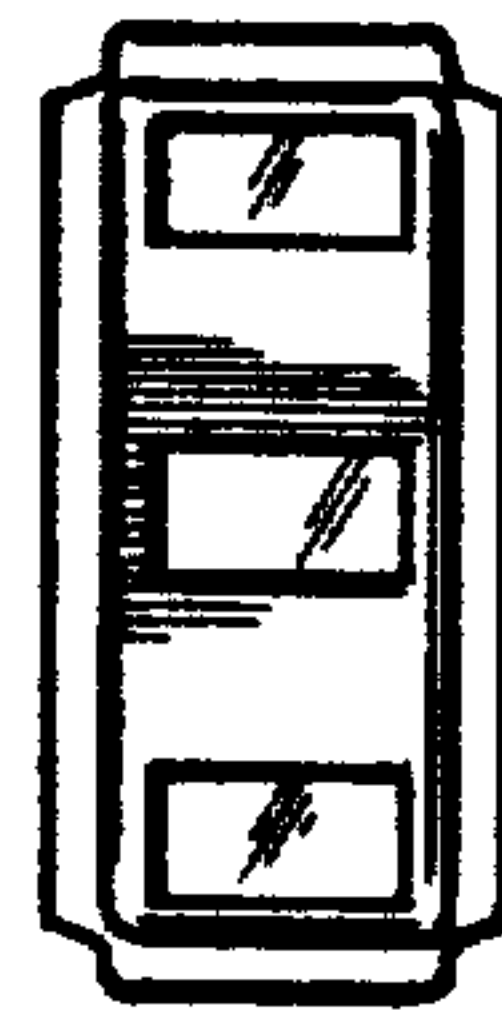

FIG. 2



FIG. 3

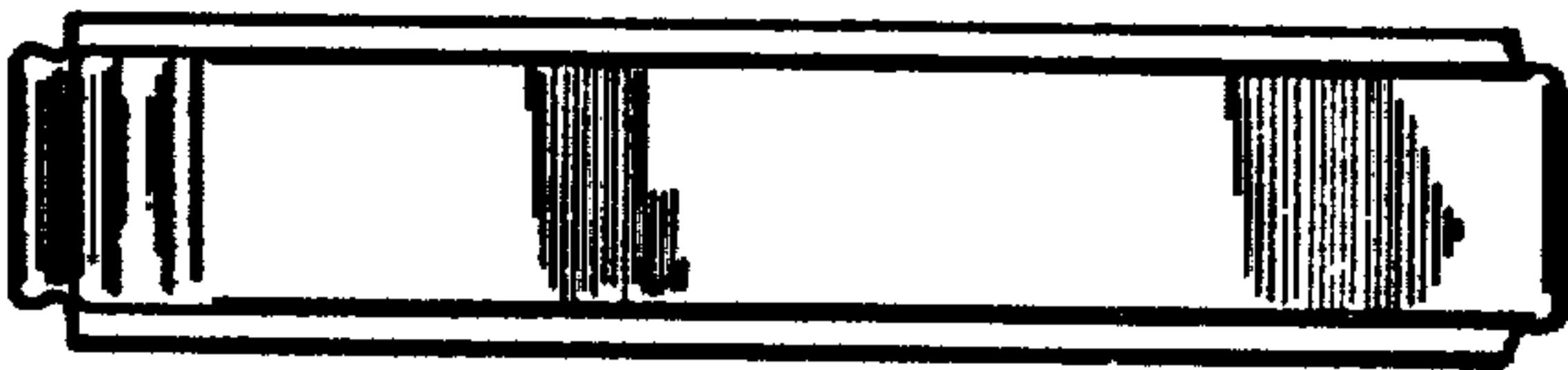

FIG. 4

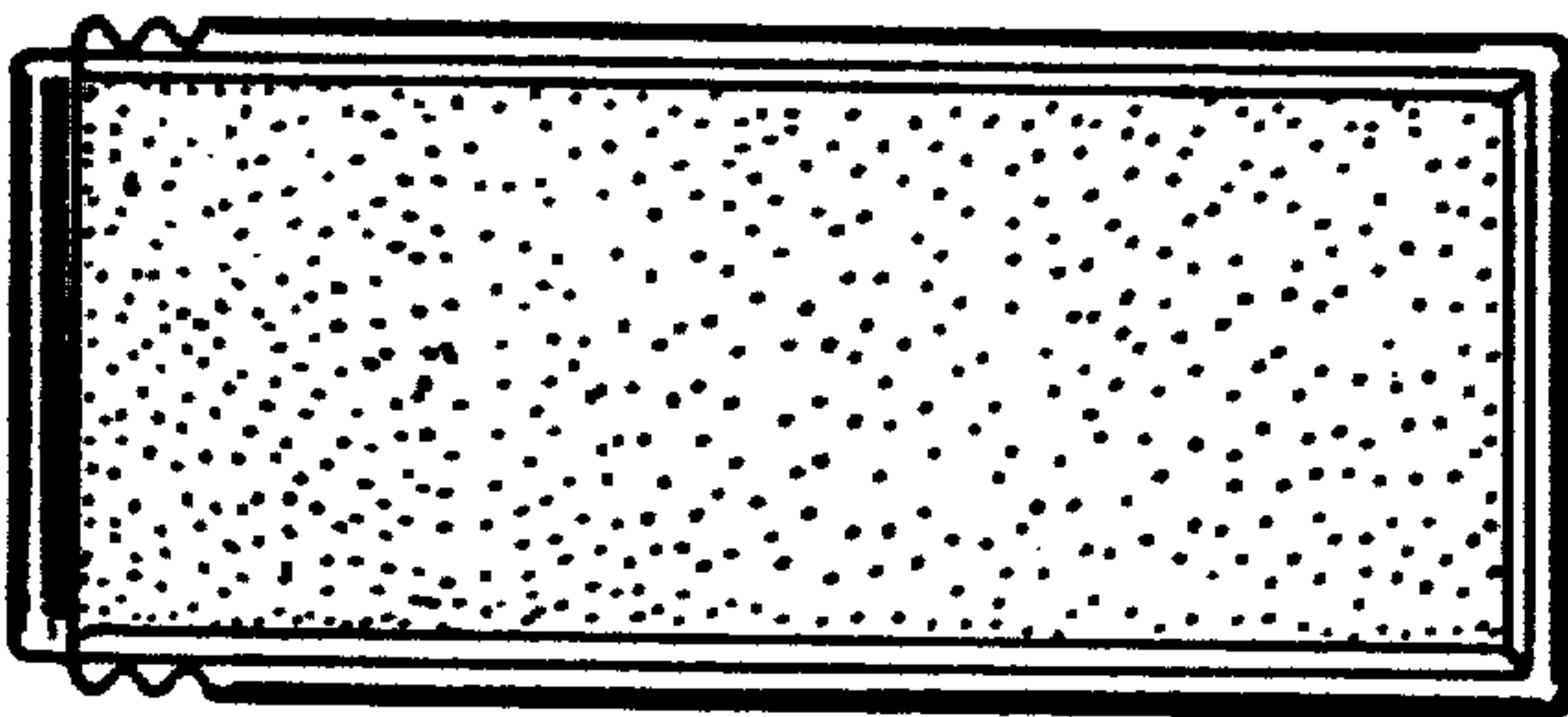

FIG. 5

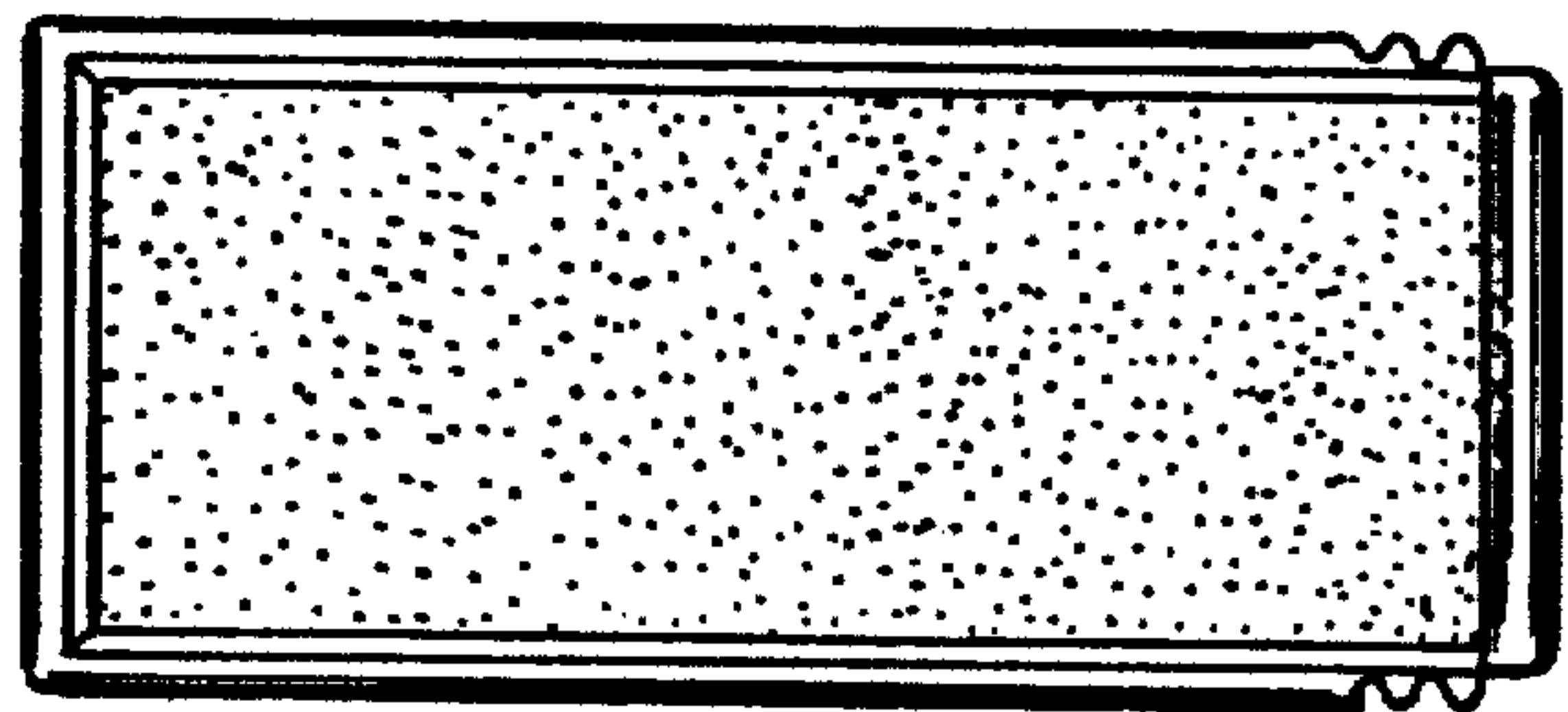

FIG. 7

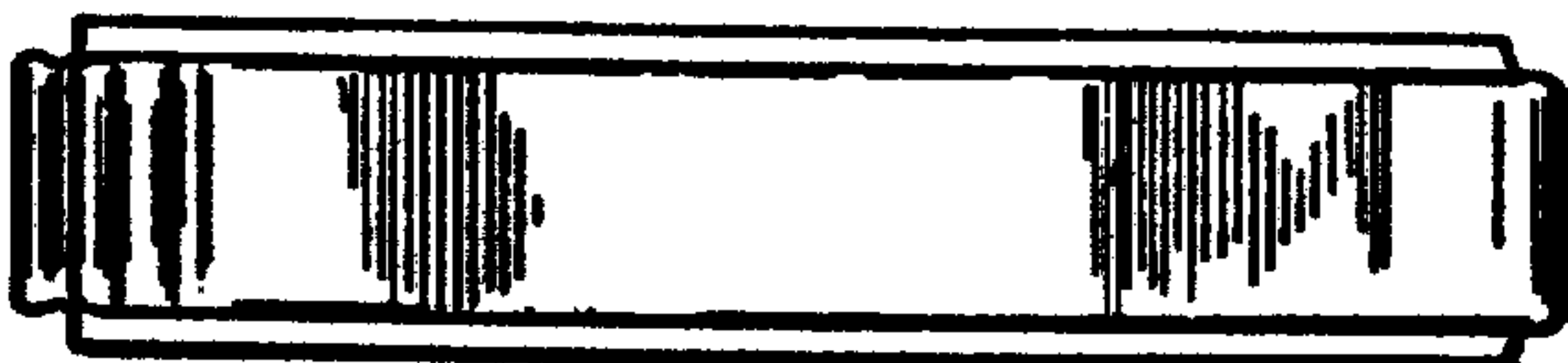

FIG. 6