

[54] COVERED FOOD BOWL OR SIMILAR ARTICLE

[75] Inventor: James Lloyd Thrush, Lancaster, Ohio

[73] Assignee: Anchor Hocking Corporation, Lancaster, Ohio

[\*\*] Term: 14 Years

[21] Appl. No.: 604,444

[22] Filed: Aug. 13, 1975

[51] Int. Cl. .... D7-01

[52] U.S. Cl. .... D7/5

[58] Field of Search ..... D7/5, 1, 3, 8, 80; D29/23 C, 23 D; D34/11 R, 2 A, 2 B; D9/23, 32, 195, 199

[56] References Cited

U.S. PATENT DOCUMENTS

D. 75,954	8/1928	Charpentier	.....	D9/35
D. 99,533	5/1936	Straus	.....	D7/5
D. 140,213	1/1945	Miller	.....	D29/23 B
D. 155,361	9/1949	Rapp	.....	D7/80
D. 165,830	2/1952	Dworkin	.....	D7/80
D. 197,791	3/1964	Friedman et al.	.....	D7/8 X

OTHER PUBLICATIONS

Tableware International, July 1973, p. 60, Chicken on Nest—r. middle panel.

Primary Examiner—Winifred E. Herrmann  
Attorney, Agent, or Firm—Joseph J. Previto

[57] CLAIM

The ornamental design for a covered food bowl or similar article, substantially as shown and described.

DESCRIPTION

FIG. 1 is a perspective view of a covered food bowl or similar article showing my new design;

FIG. 2 is a side view thereof;

FIG. 3 is a top view thereof;

FIG. 4 is an exploded view thereof;

FIG. 5 is a front view thereof;

FIG. 6 is a rear view thereof;

FIG. 7 is a bottom view thereof;

FIG. 8 is a sectional view taken along line 8-8 of FIG. 2; and

FIG. 9 is a developed plan view of the bowl thereof, a portion of the repeats being shown in full lines, it being understood that the facets are continuous in the path of the dot and dash lines shown.

The facets have been partially omitted from FIGS. 2, 5, 6, 7 and 9 for convenience of illustration.



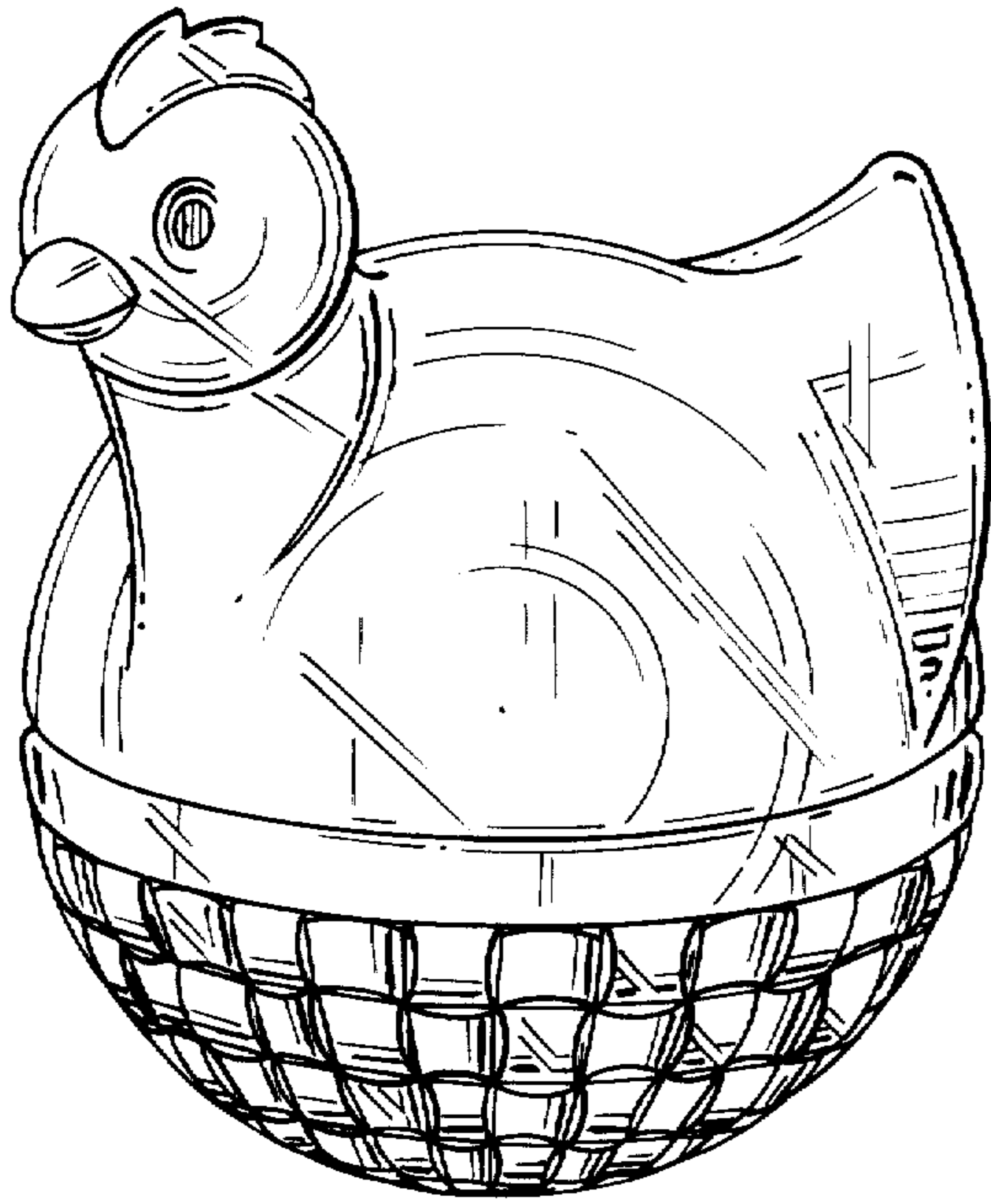

Fig. 1.

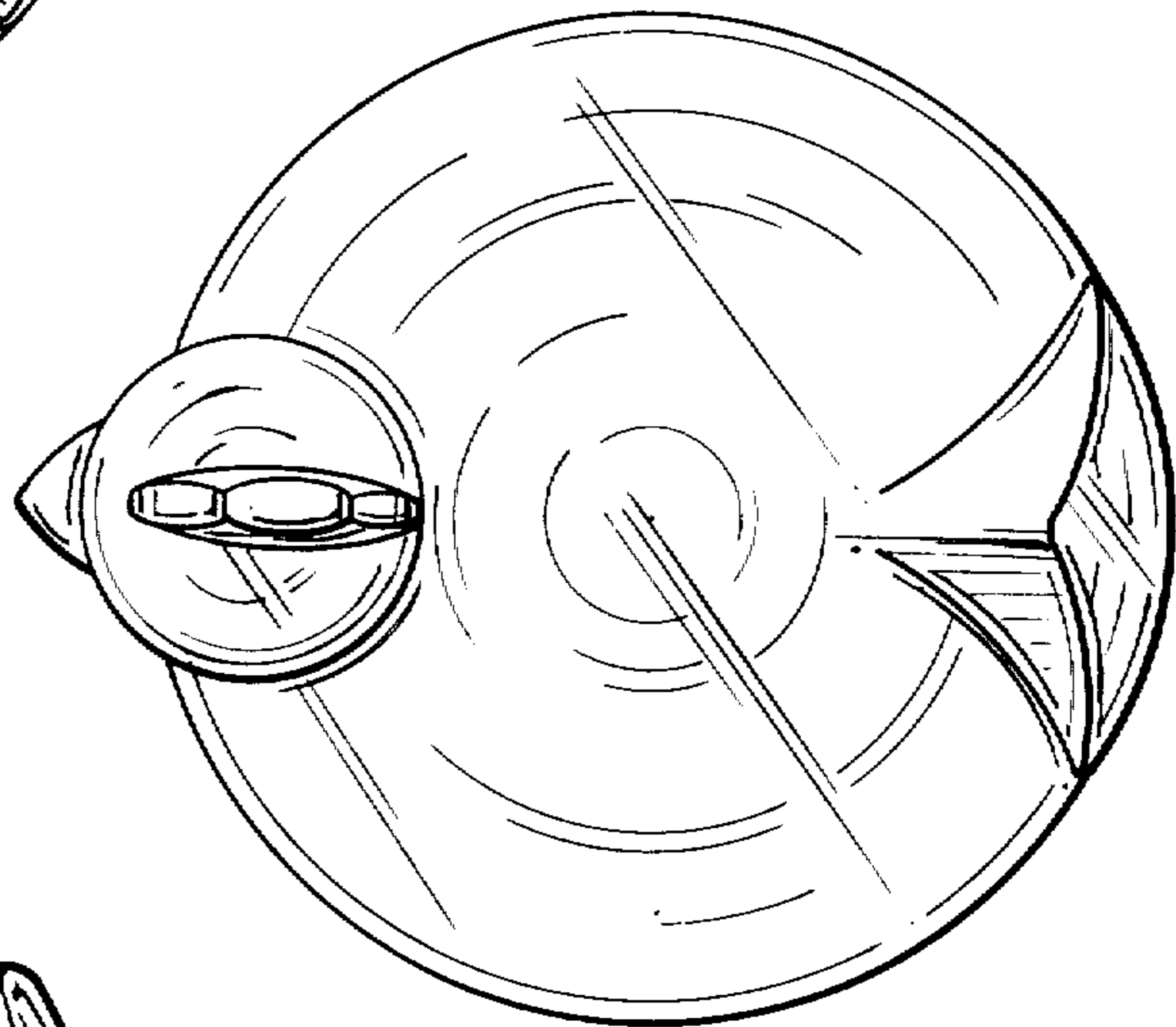
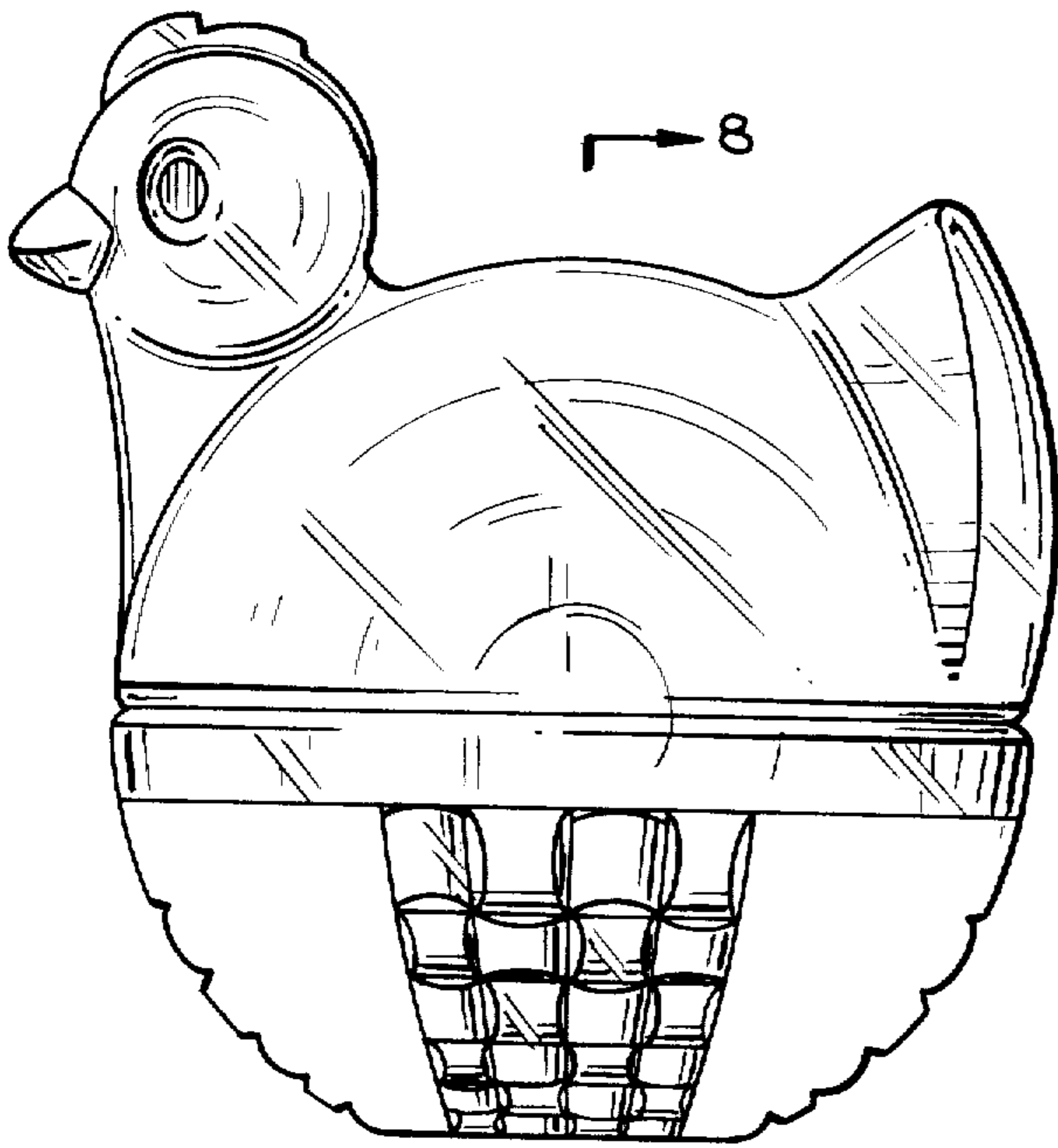

Fig. 3.



8

Fig. 2.

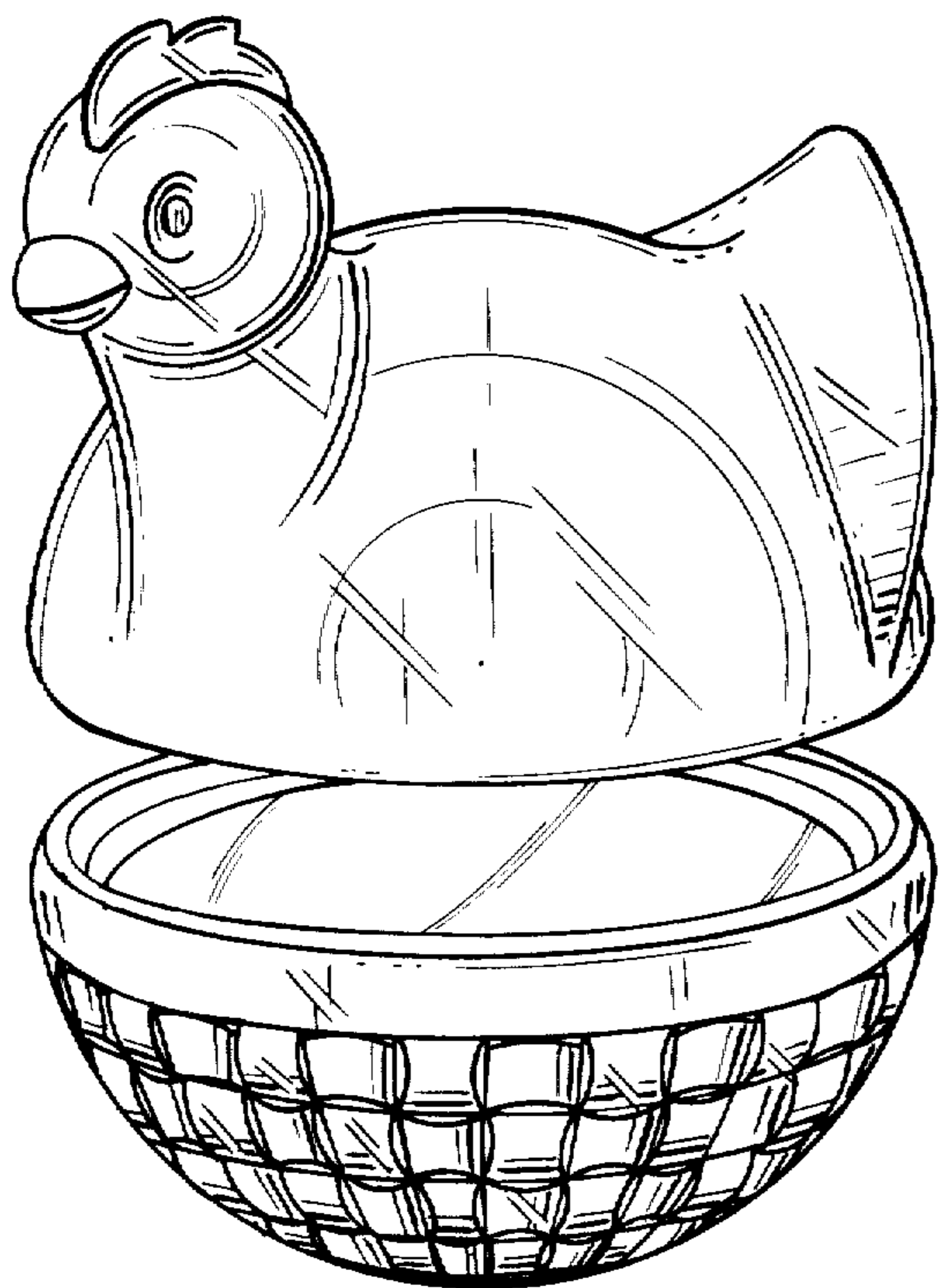

Fig. 4.

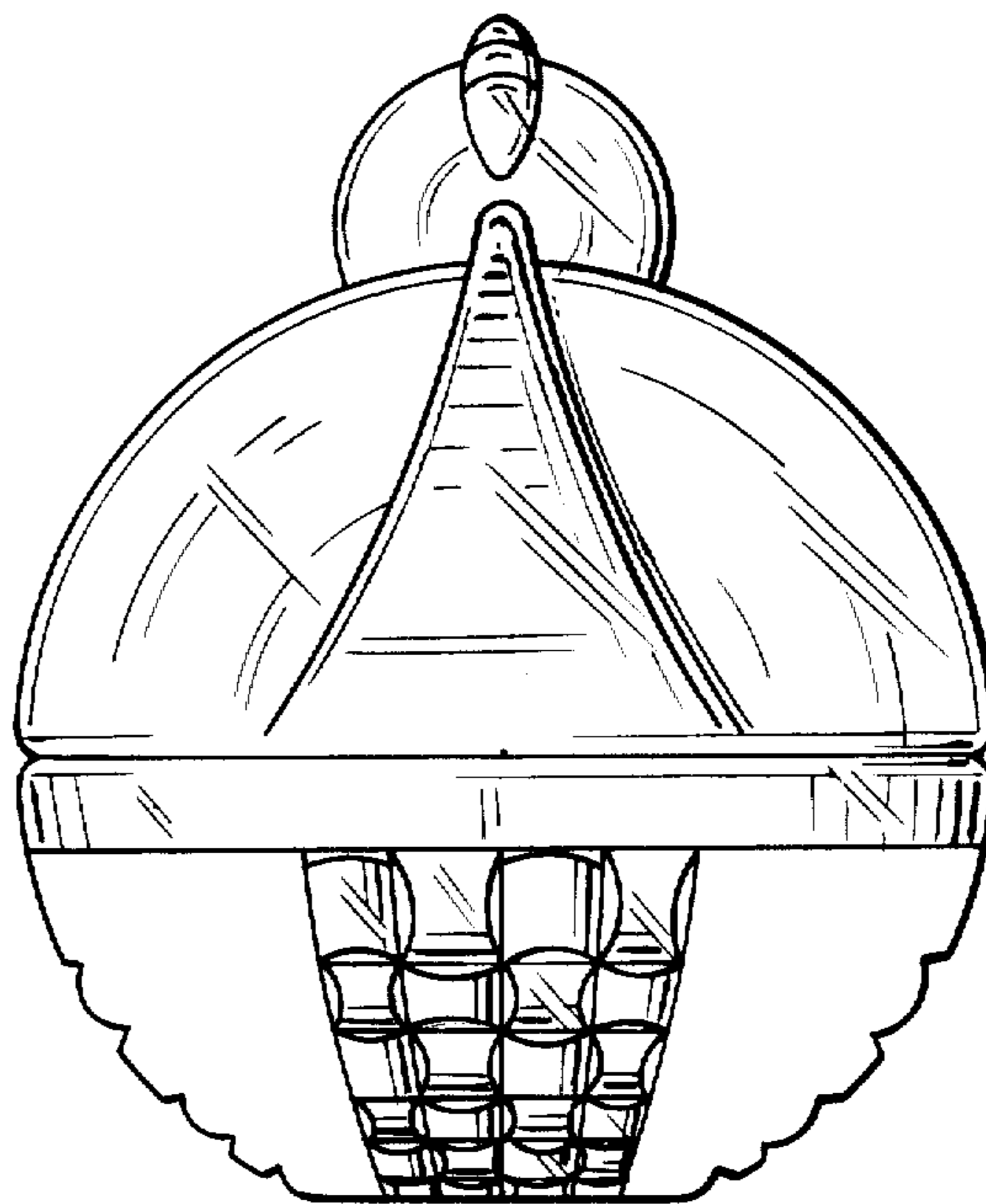

Fig. 5.

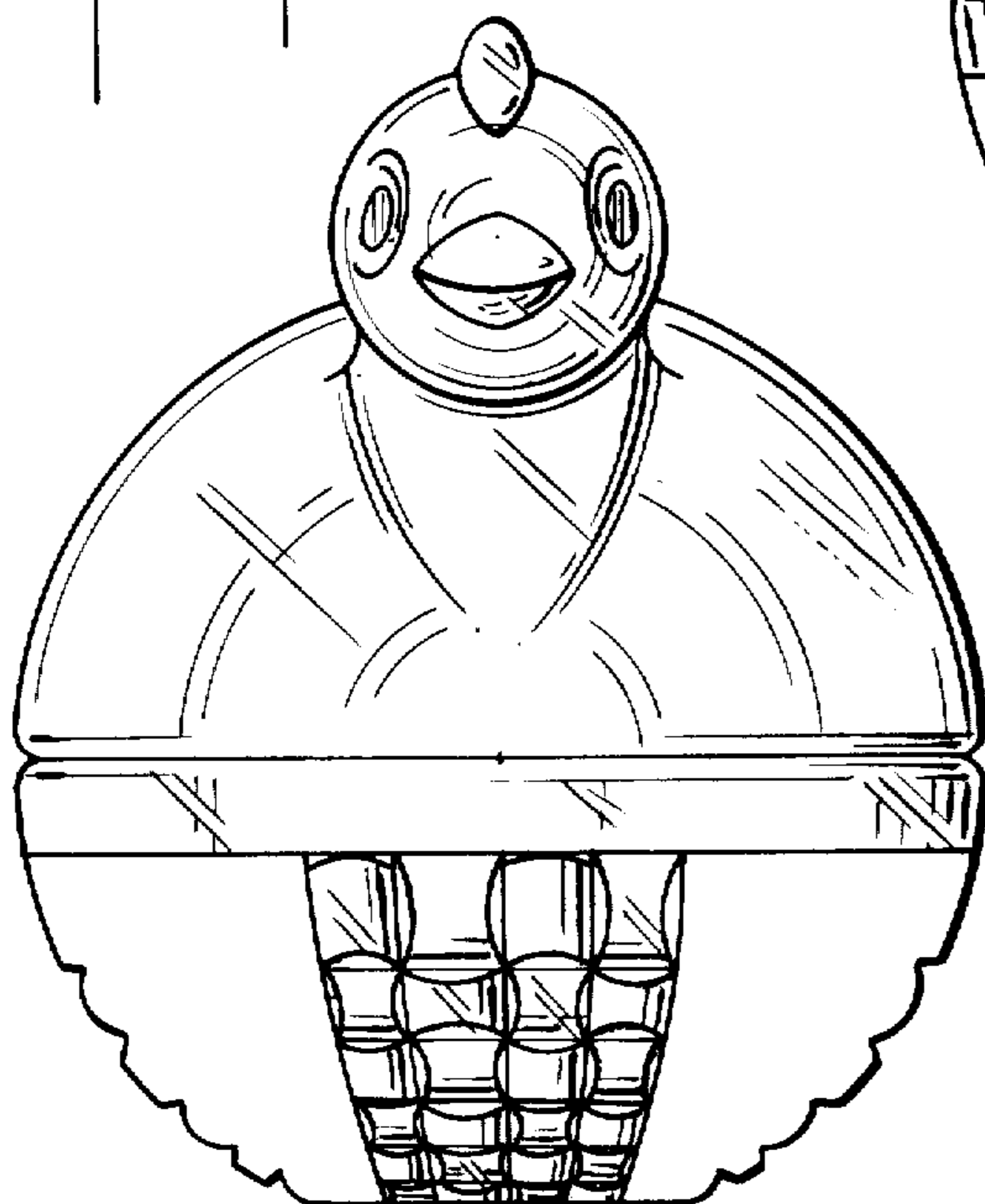

Fig. 6.

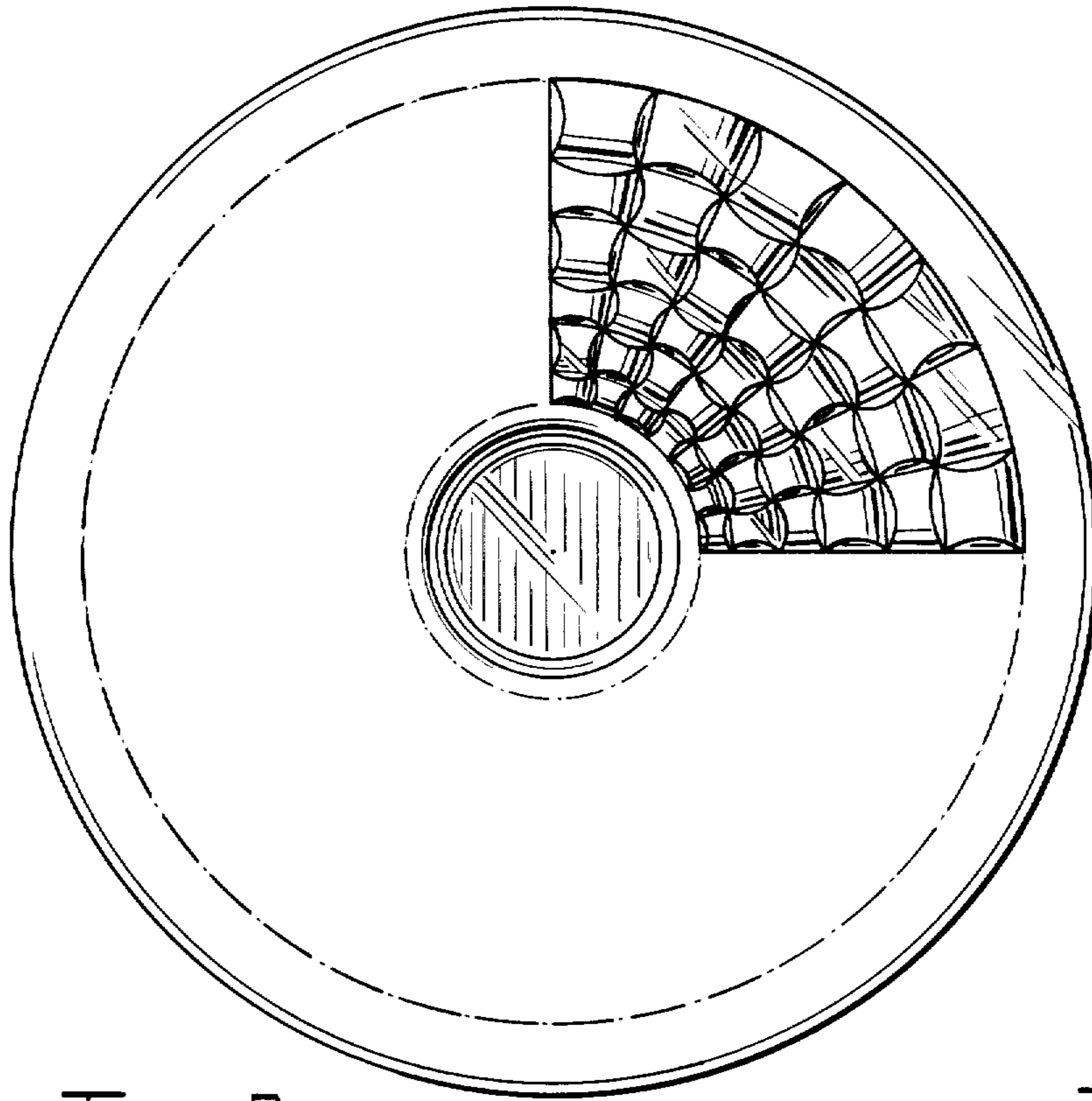

Fig. 9.

Fig. 8.

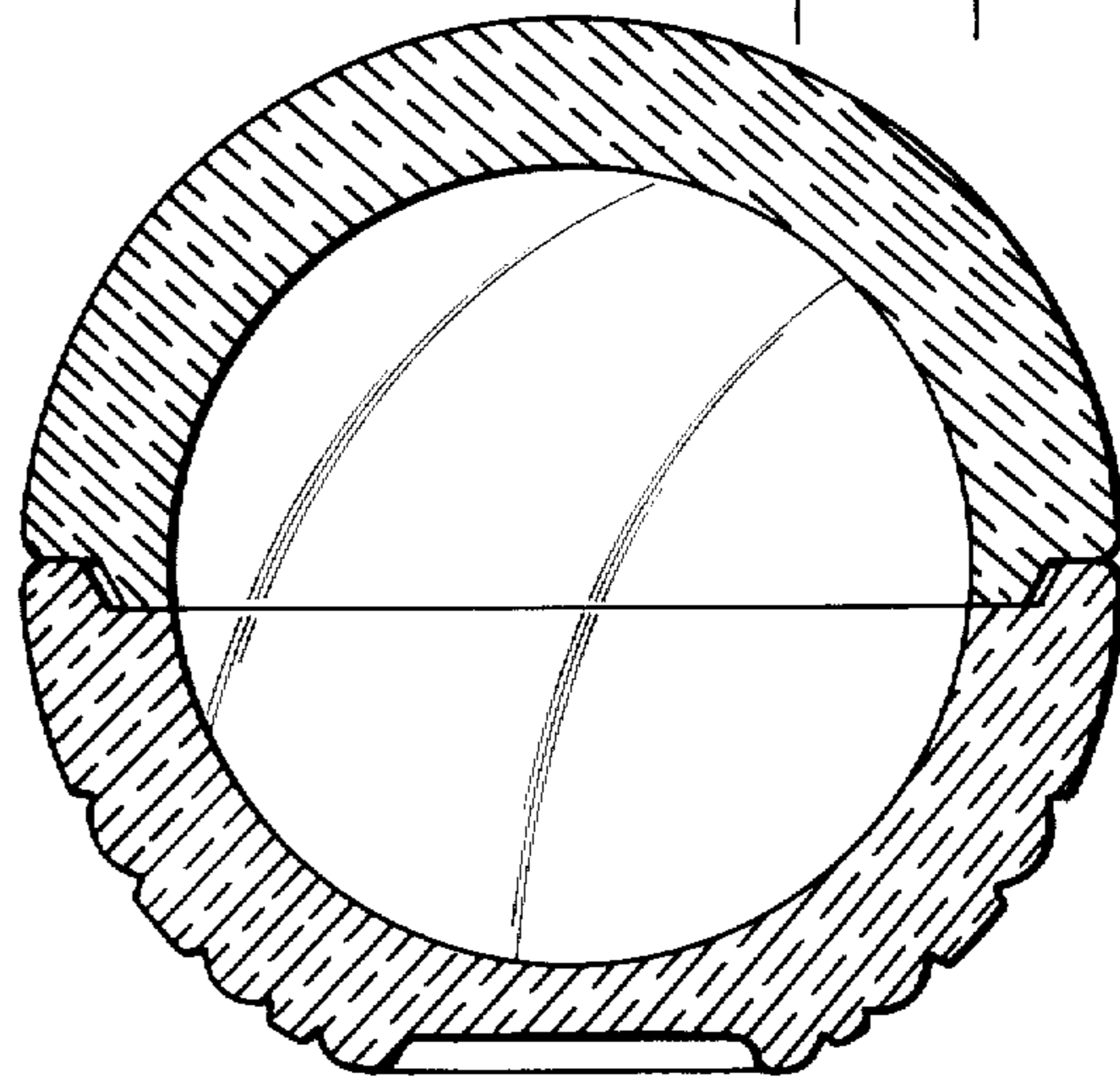

Fig. 7.

