

[54] LAMP

[76] Inventors: Saul Corber, 5606 Alpine Ave.;
Murray E. Moss, 4874 Cote des
Neiges, Apt. 301, both of Montreal,
Quebec, Canada

[**] Term: 14 Years

[21] Appl. No.: 516,598

[22] Filed: Oct. 21, 1974

[51] Int. Cl. D26-02

[52] U.S. Cl. D48/24 A

[58] Field of Search D48/24 A; 240/10.5,
240/10.6, 10.61, 10.63, 10.65, 10.66, 10.67,
10.68; D10/112

[56] References Cited

U.S. PATENT DOCUMENTS

881,264	3/1908	Schermerhorn	D48/24 A
3,256,428	6/1966	Schwartz	240/10.65
3,829,332	8/1974	Iizuka et al.	240/10.66 X

FOREIGN PATENT DOCUMENTS

97,746 2/1923 Switzerland 240/10.65

OTHER PUBLICATIONS

Hardware Age — Jan. 15, 1959 — p. 113 — Life-Lite
Rechargeable Flashlight.

Primary Examiner—Susie J. Mercer
Assistant Examiner—Catherine Kemper
Attorney, Agent, or Firm—Ian Fincham

[57] CLAIM

The ornamental design for a lamp, as shown.

DESCRIPTION

FIG. 1 is a perspective view of a lamp of the present
design;
FIG. 2 is a top elevational view thereof;
FIG. 3 is a rear elevational view thereof;
FIG. 4 is a side elevational view thereof;
FIG. 5 is a front elevational view thereof; and
FIG. 6 is a bottom elevational view thereof.

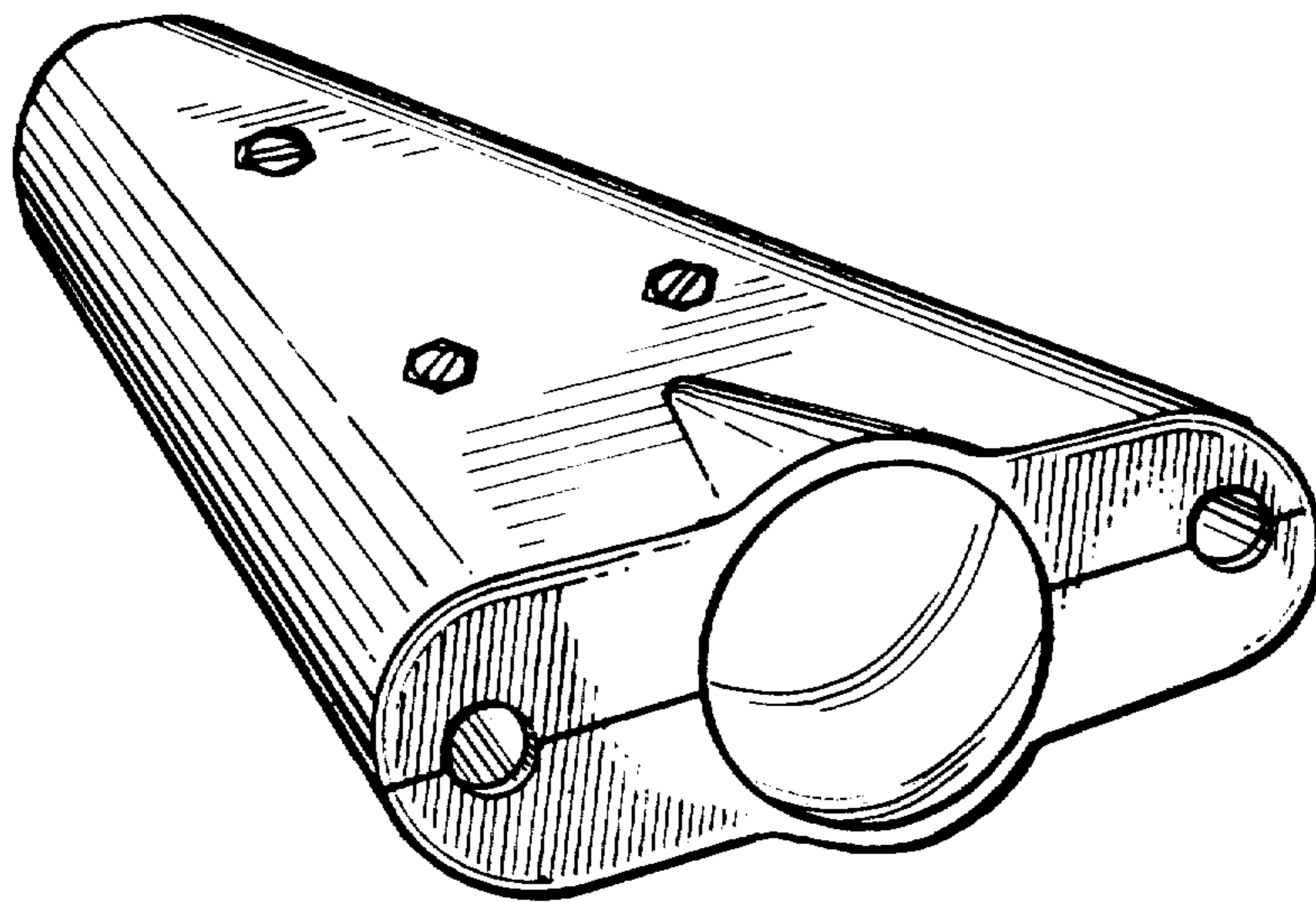

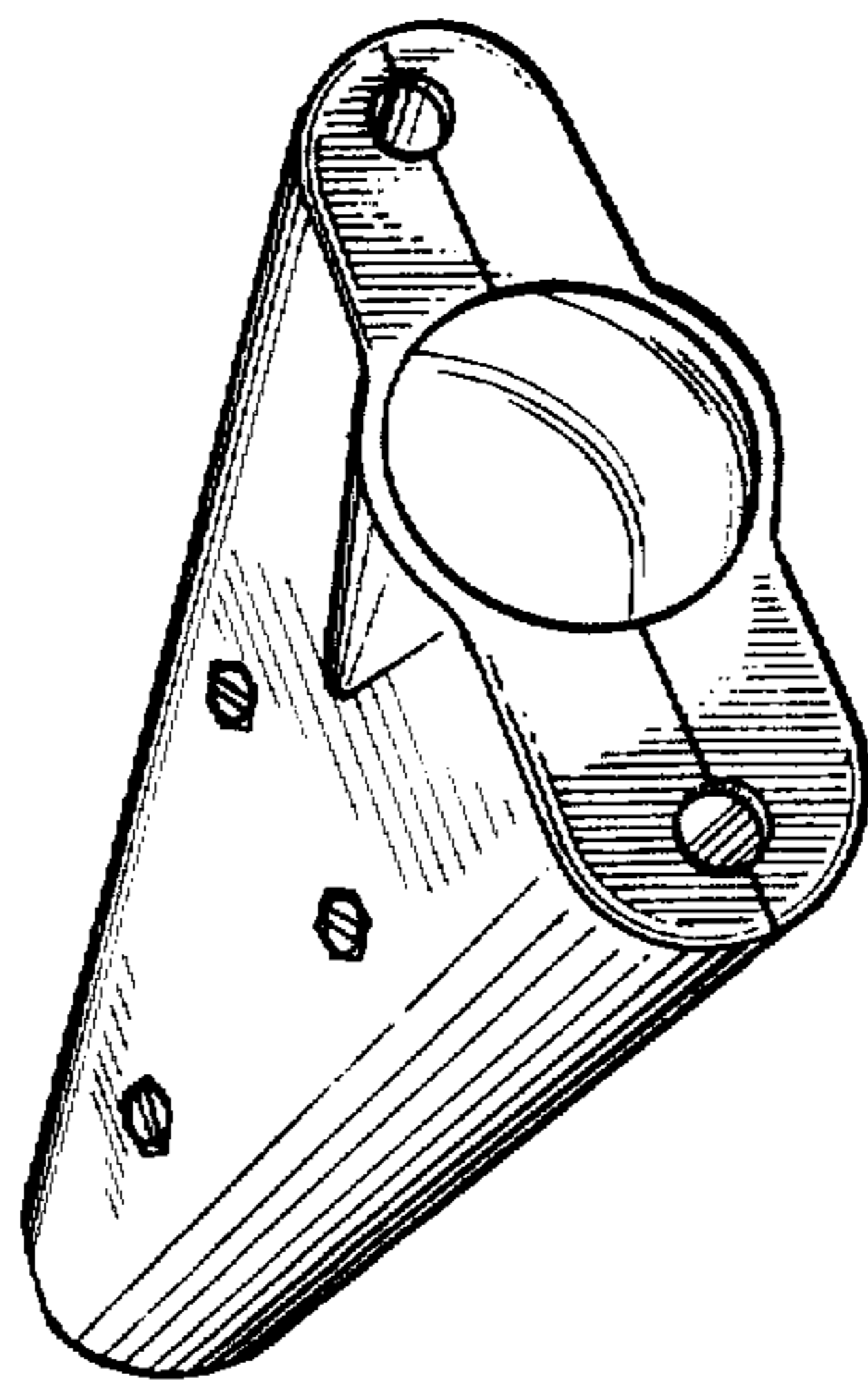

Fig. 1

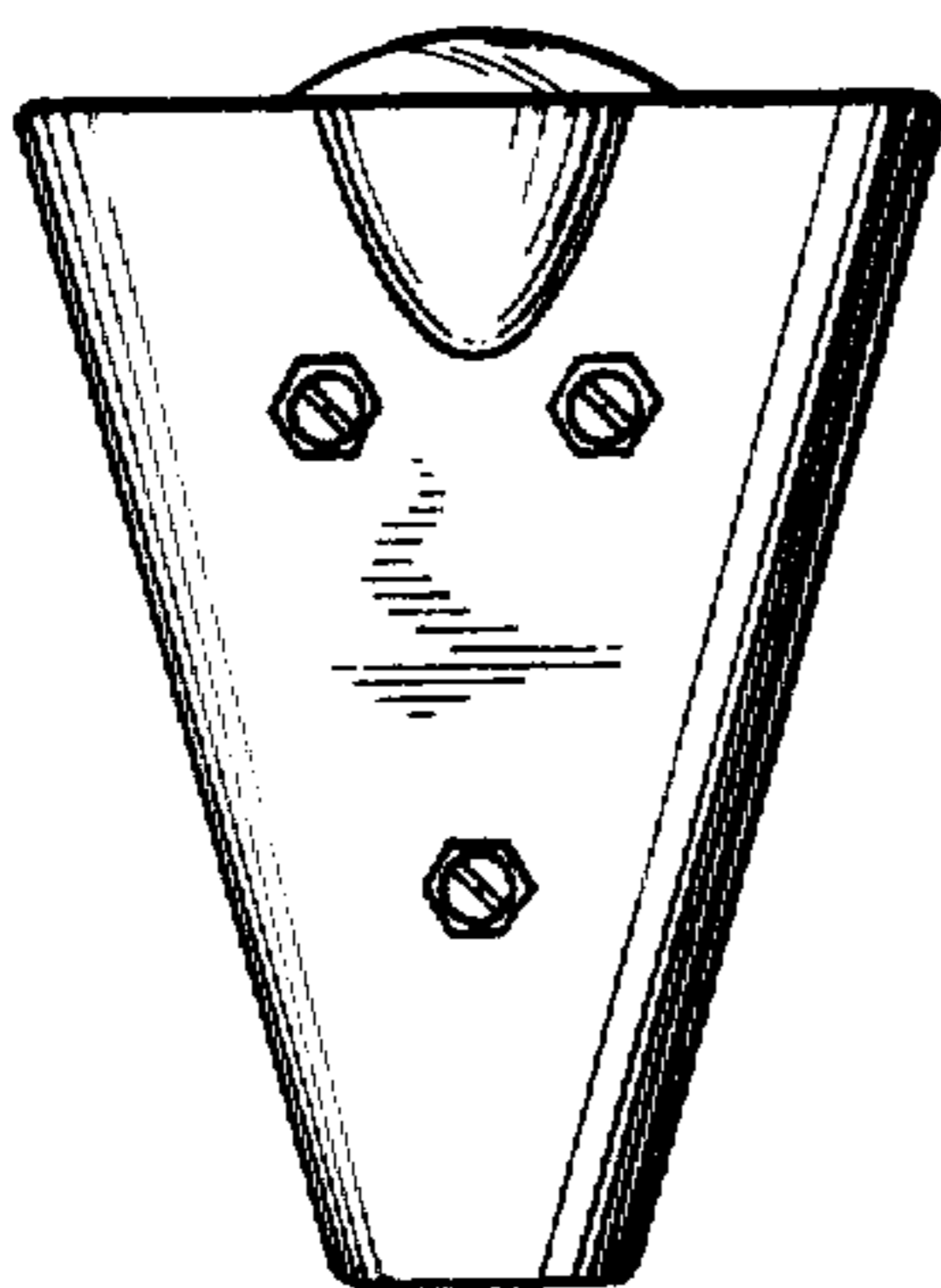

Fig. 2

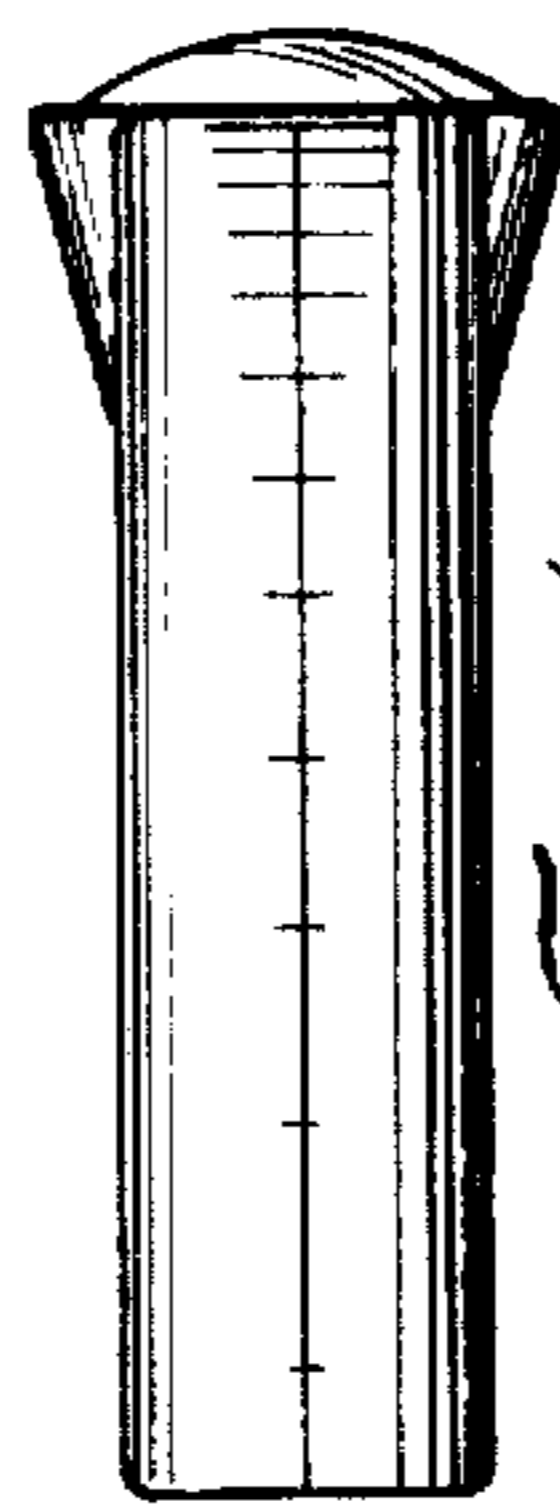

Fig. 4

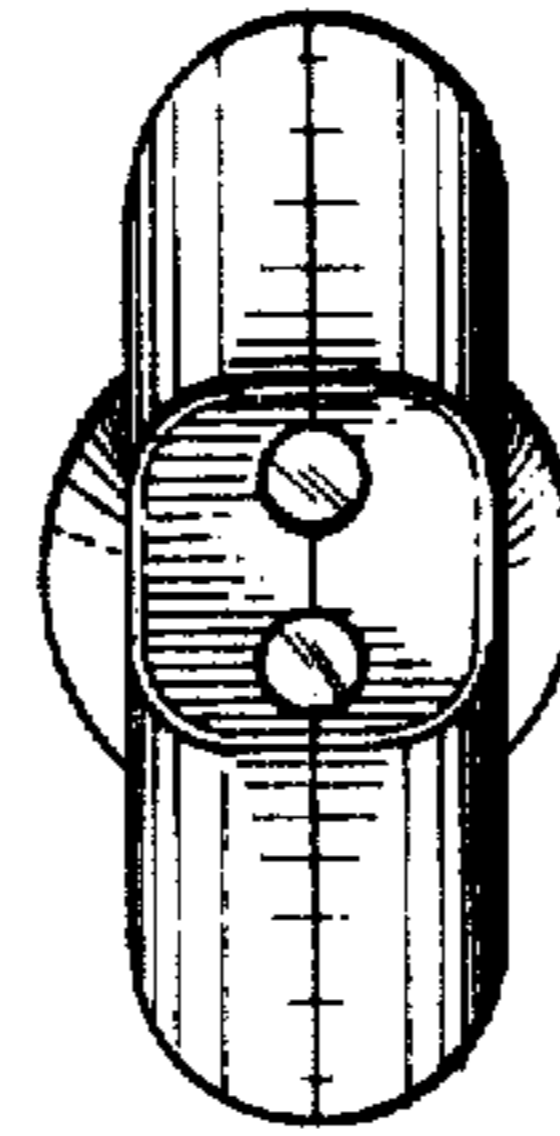

Fig. 3

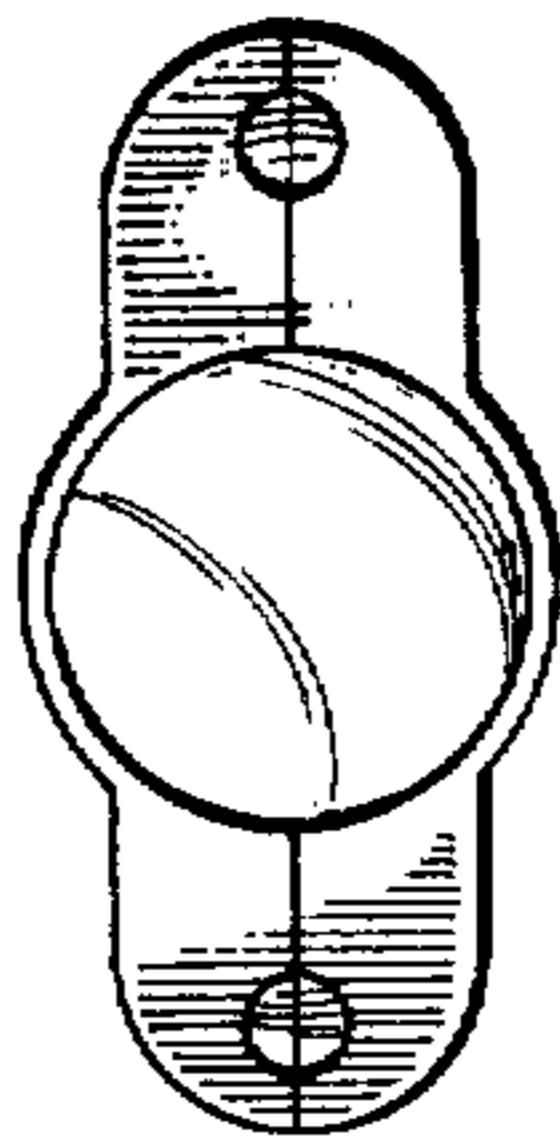

Fig. 5

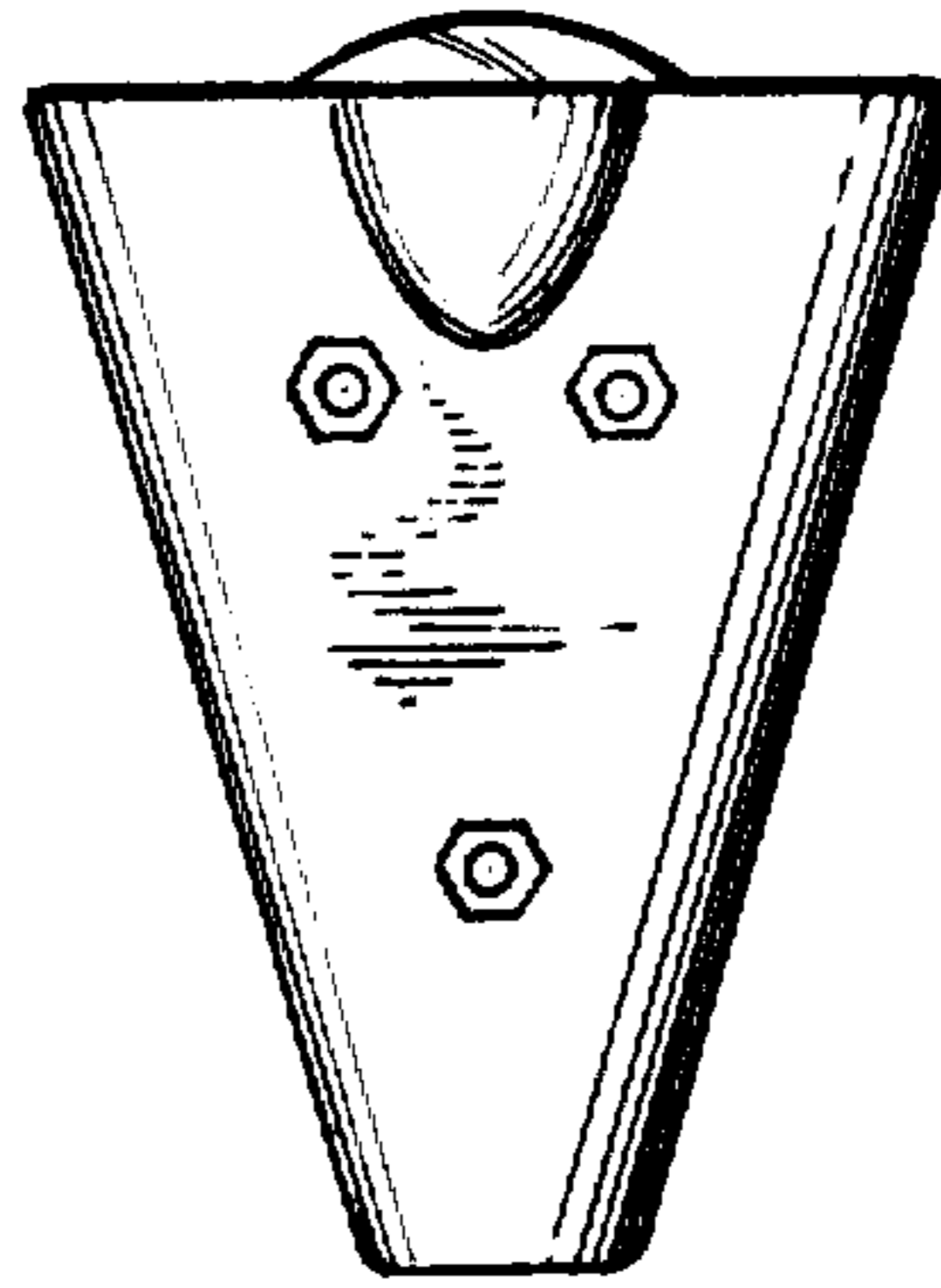

Fig. 6