

[54] ELECTRONIC CALCULATING MACHINE

[75] Inventor: Shigetoshi Hazama, Osaka, Japan

[73] Assignee: Sharp Corporation

[**] Term: 14 Years

[21] Appl. No.: 597,000

[22] Filed: July 18, 1975

[30] Foreign Application Priority Data

Jan. 22, 1975 Japan 50-3159

[51] Int. Cl. D18-01

[52] U.S. Cl. D26/5 C

[58] Field of Search D26/5 R, 5 C; D64/11 R, D64/11 A, 11 B, 11 C; 235/14 S, 14 R, 14 A

[56] References Cited

U.S. PATENT DOCUMENTS

D. 163,135	5/1951	Pangburn	D64/11 C
D. 230,484	2/1974	Yamagami	D26/5 C
D. 235,452	6/1975	Ikeda	D26/5 C
D. 236,488	8/1975	Fossella	D26/5 C

Primary Examiner—Wallace R. Burke
Assistant Examiner—Catherine Kemper
Attorney, Agent, or Firm—Paul D. Flehr

[57] CLAIM

The ornamental design for an electronic calculating machine, as shown and described.

DESCRIPTION

FIG. 1 is a perspective view taken generally from a frontal side angle illustrating the electronic calculating machine showing my new design, the same being shown in an open position;

FIG. 2 is a perspective view showing the same in a closed state thereof;

FIG. 3 is a left side elevational view thereof;

FIG. 4 is a rear elevational view thereof;

FIG. 5 is a front elevational view thereof;

FIG. 6 is a bottom view thereof;

FIG. 7 is a plan view thereof;

FIG. 8 is a left side elevational view in an operative state thereof;

FIG. 9 is a rear elevational view in an operative state thereof;

FIG. 10 is a front elevational view in an operative state thereof;

FIG. 11 is a bottom view in an operative state thereof; and

FIG. 12 is a plan view in an operative state.

The broken line disclosure of the display numerals in FIG. 1 is for illustrative purposes and forms no part of the claimed design.

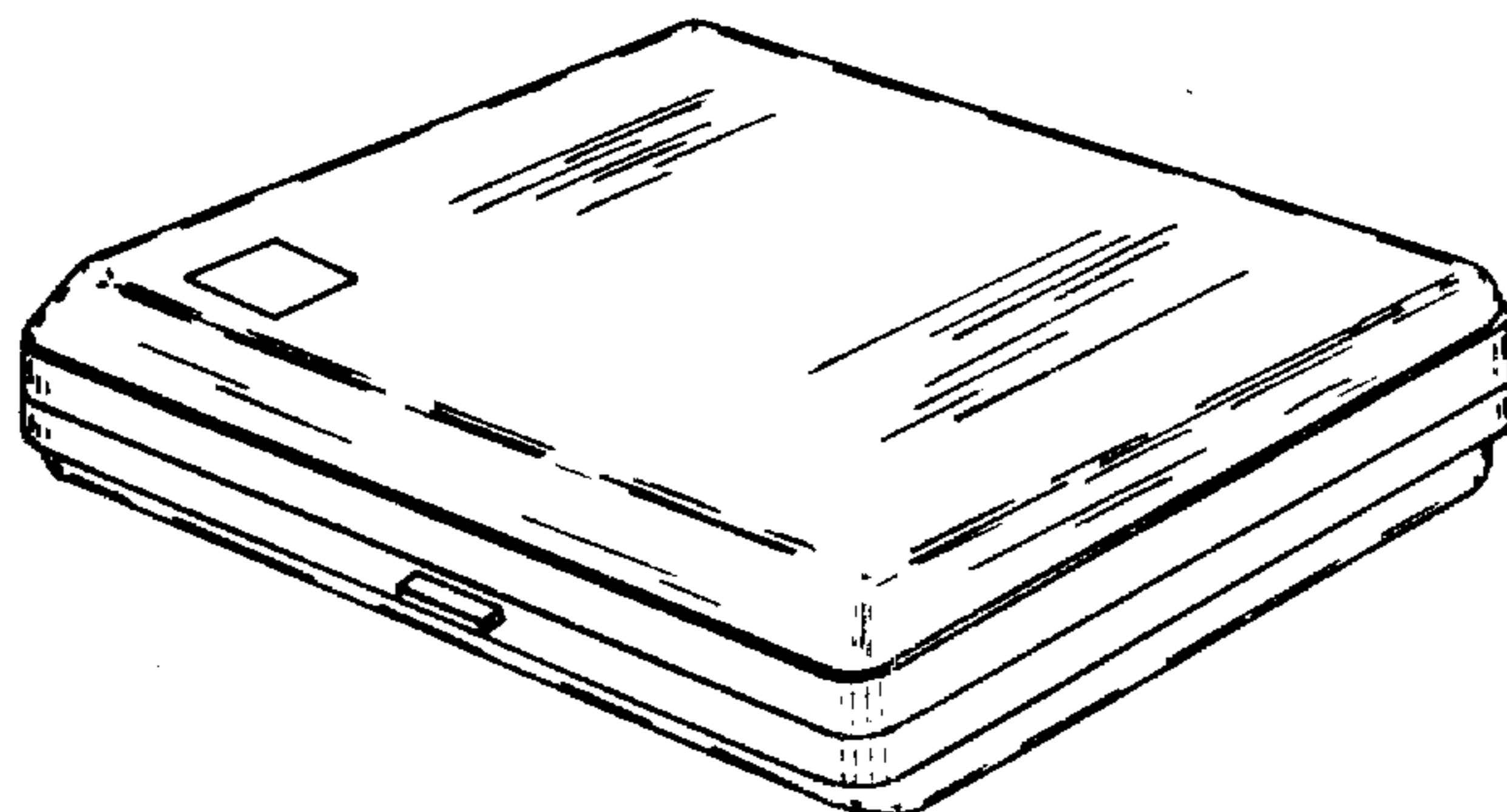
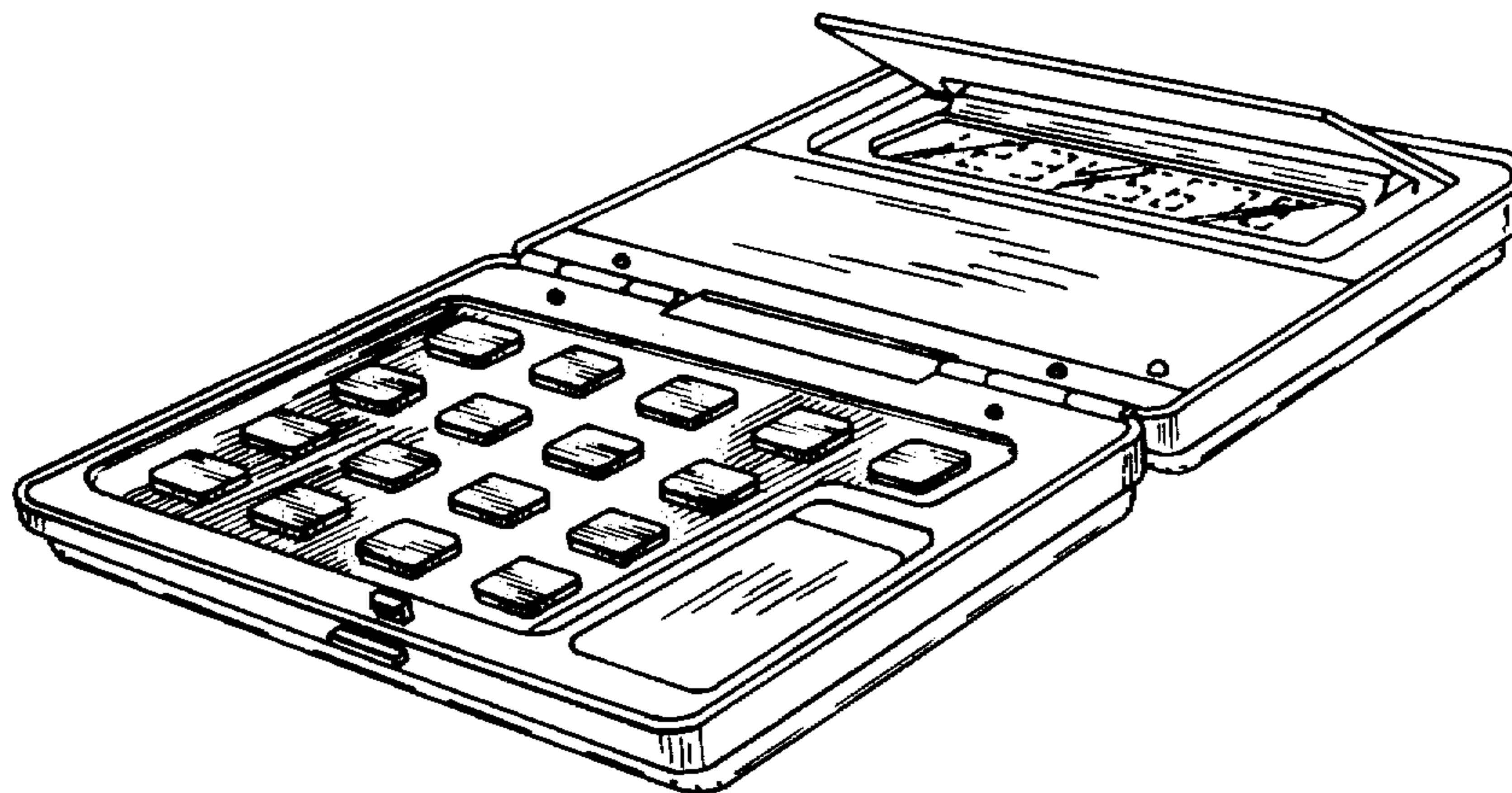

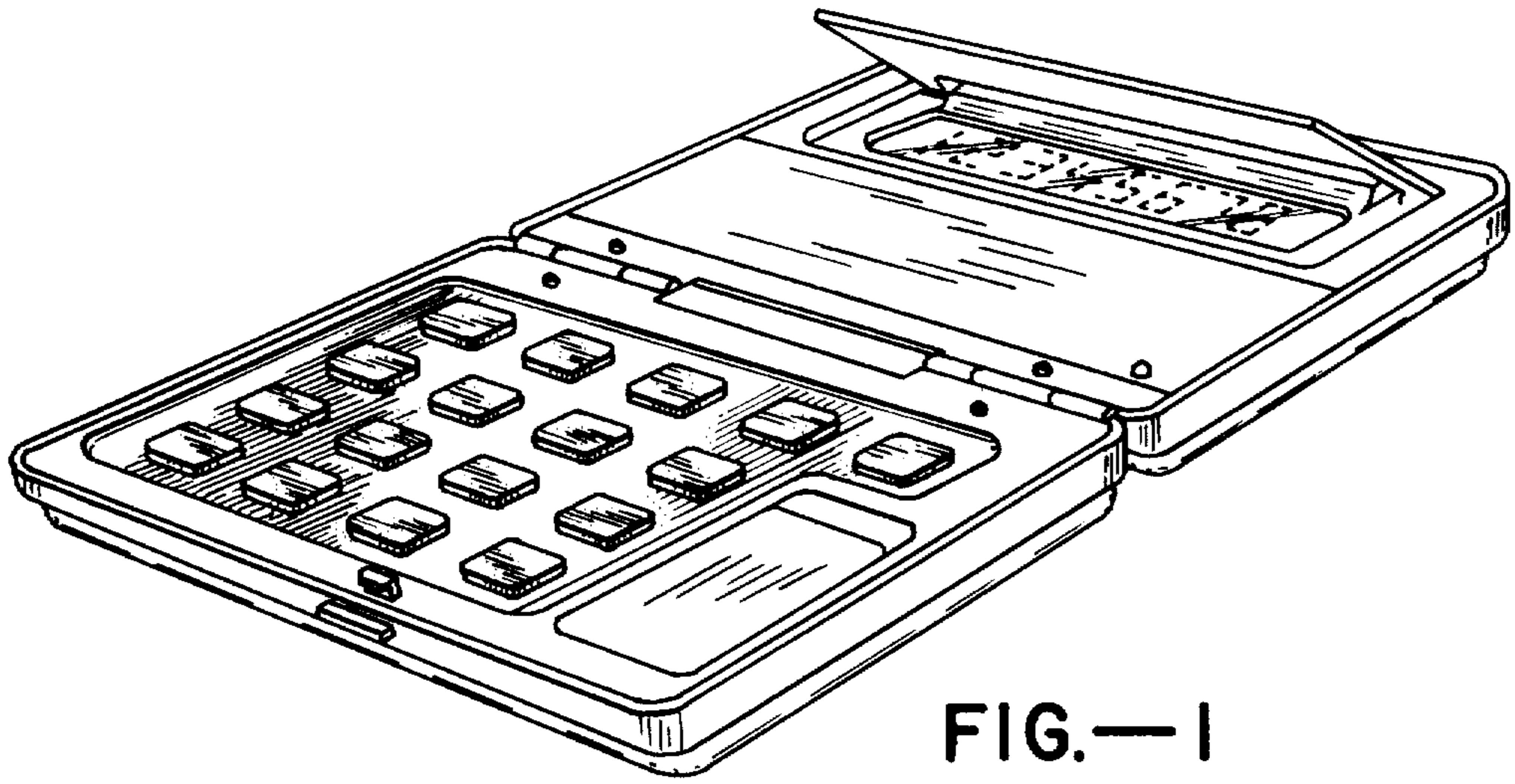

FIG.—1

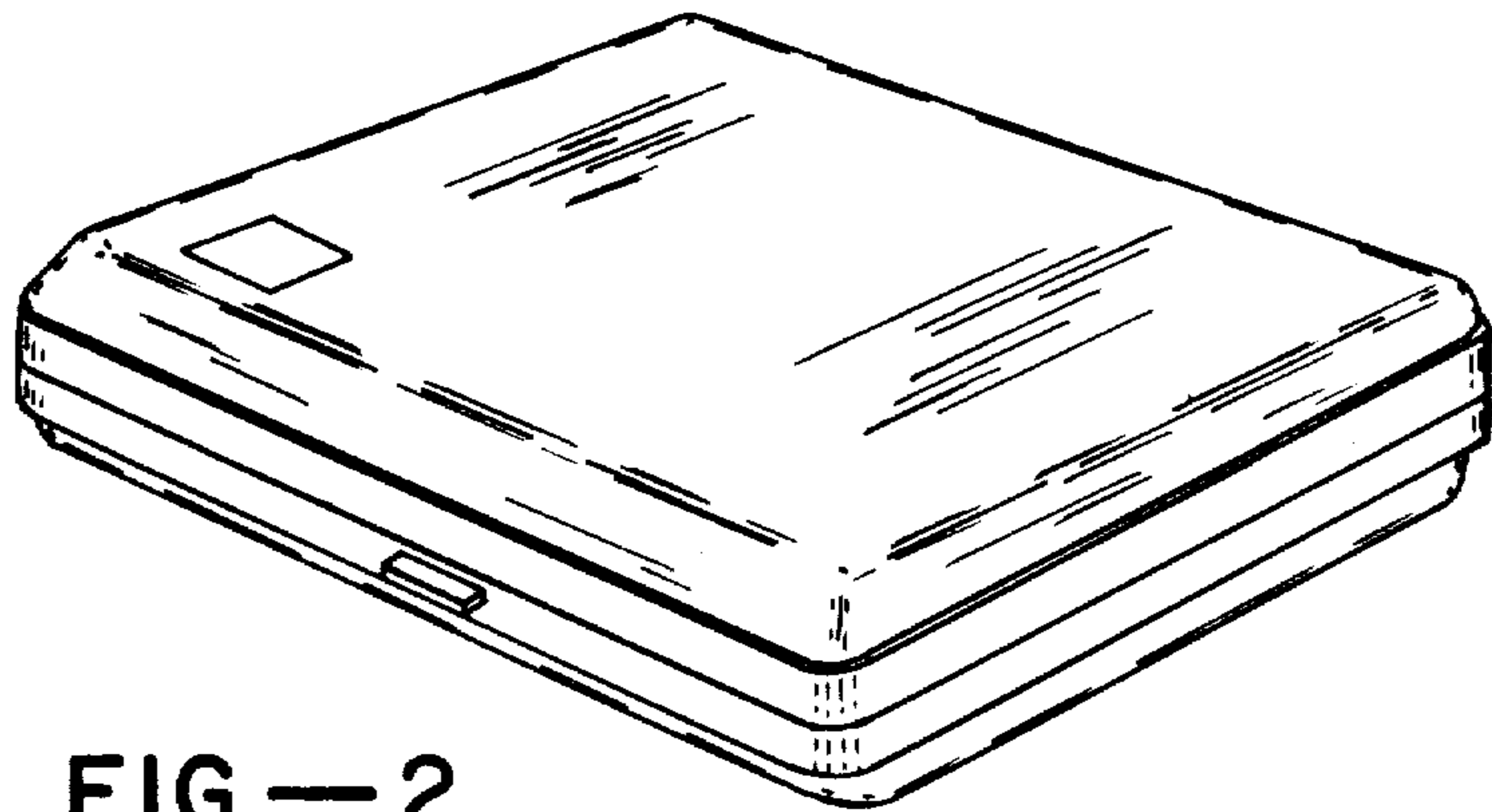

FIG.—2

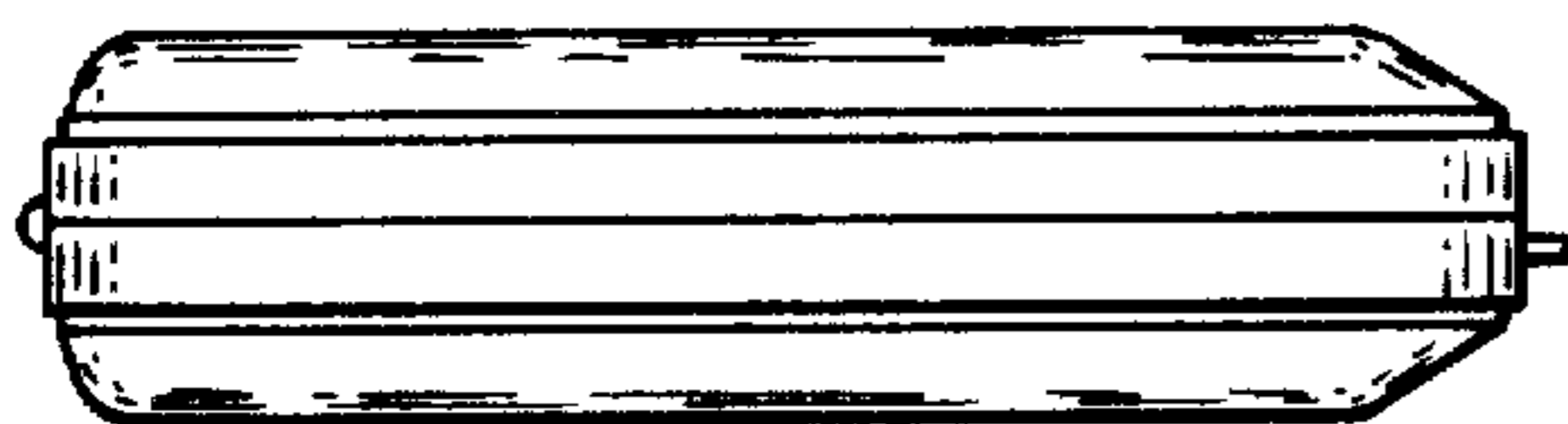

FIG.—3

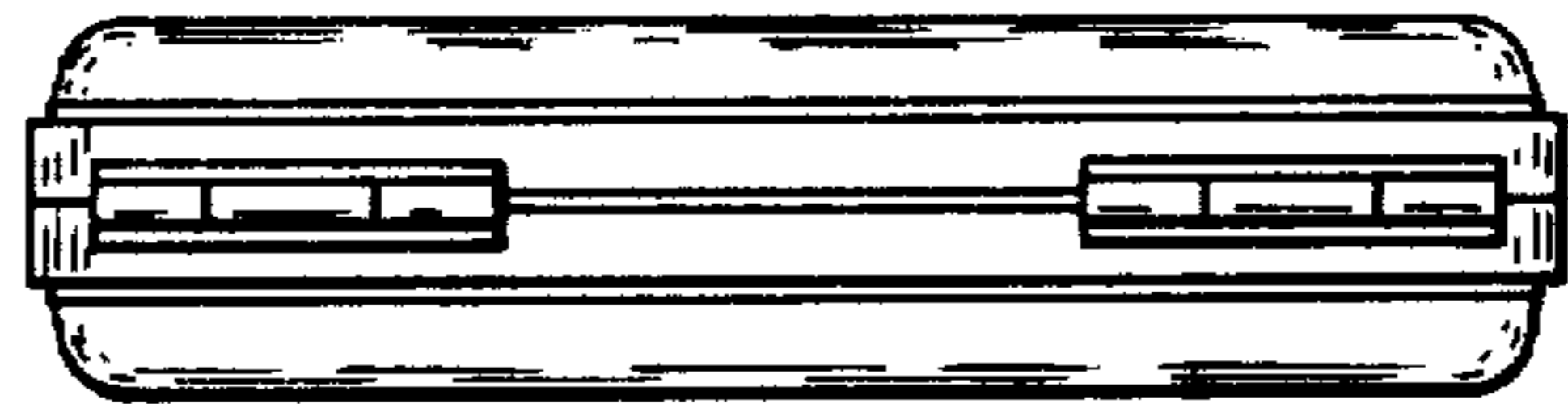

FIG.—4

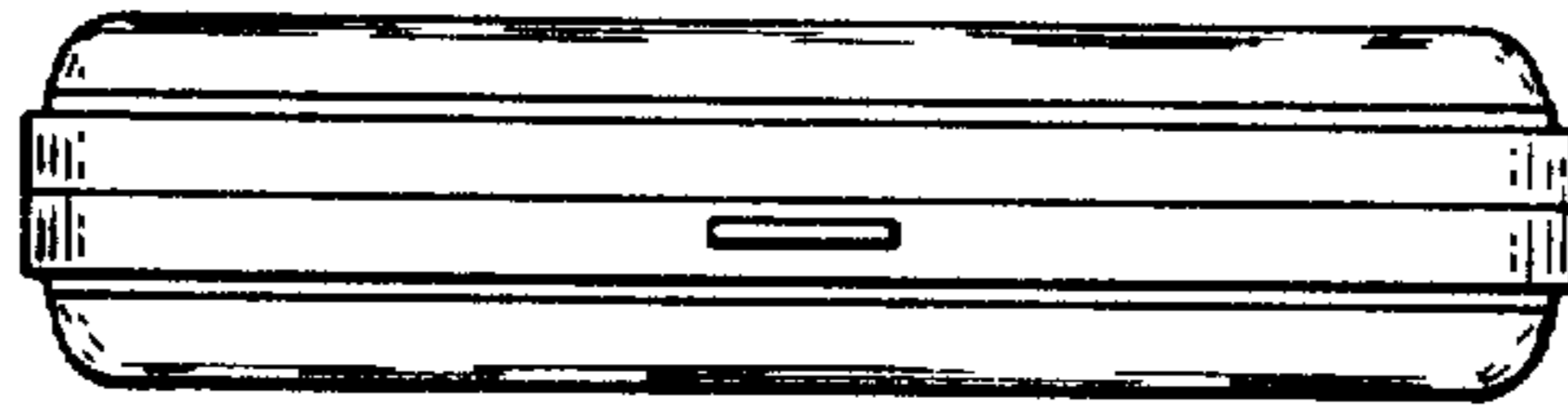

FIG.— 5

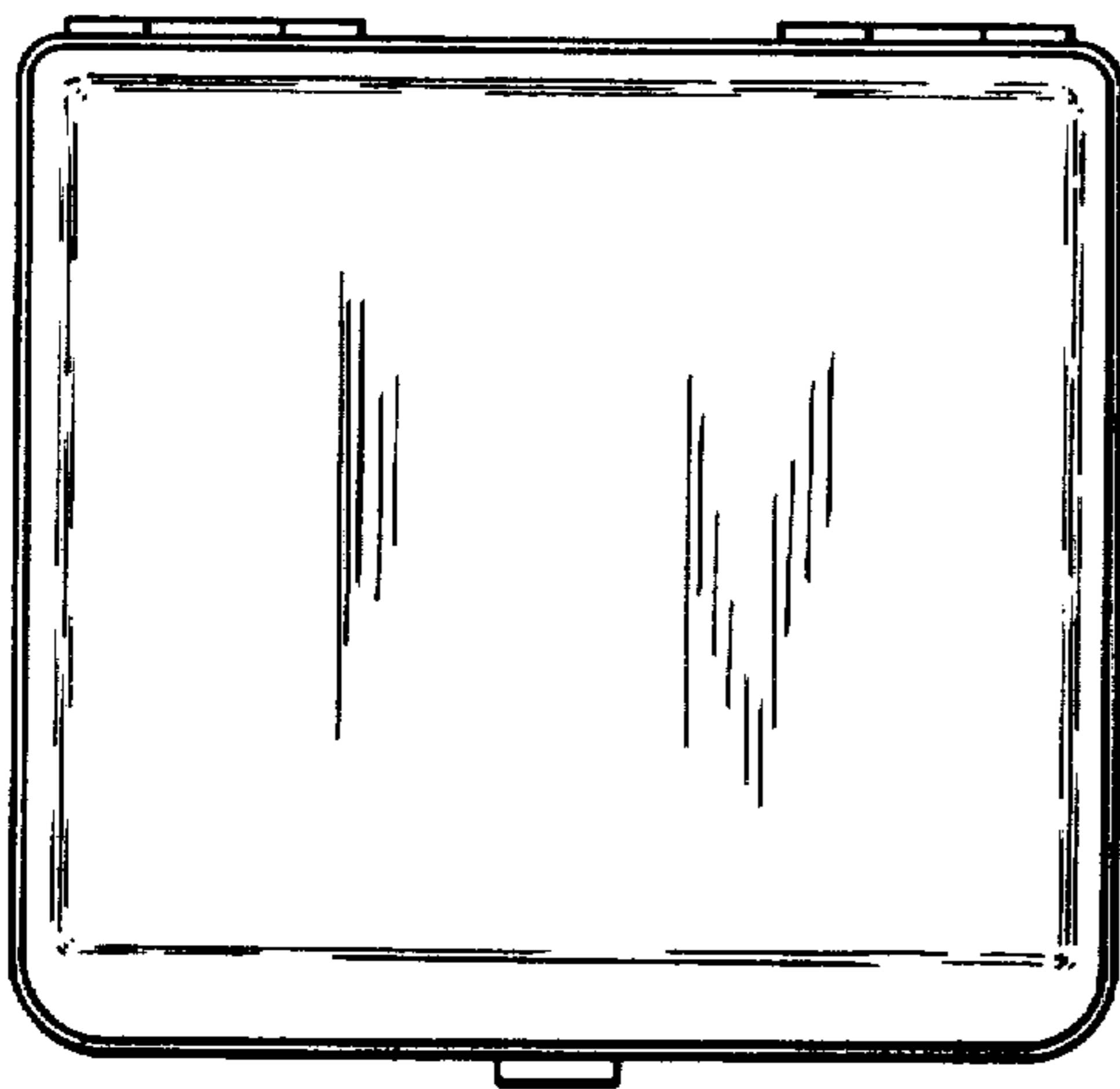

FIG.— 6

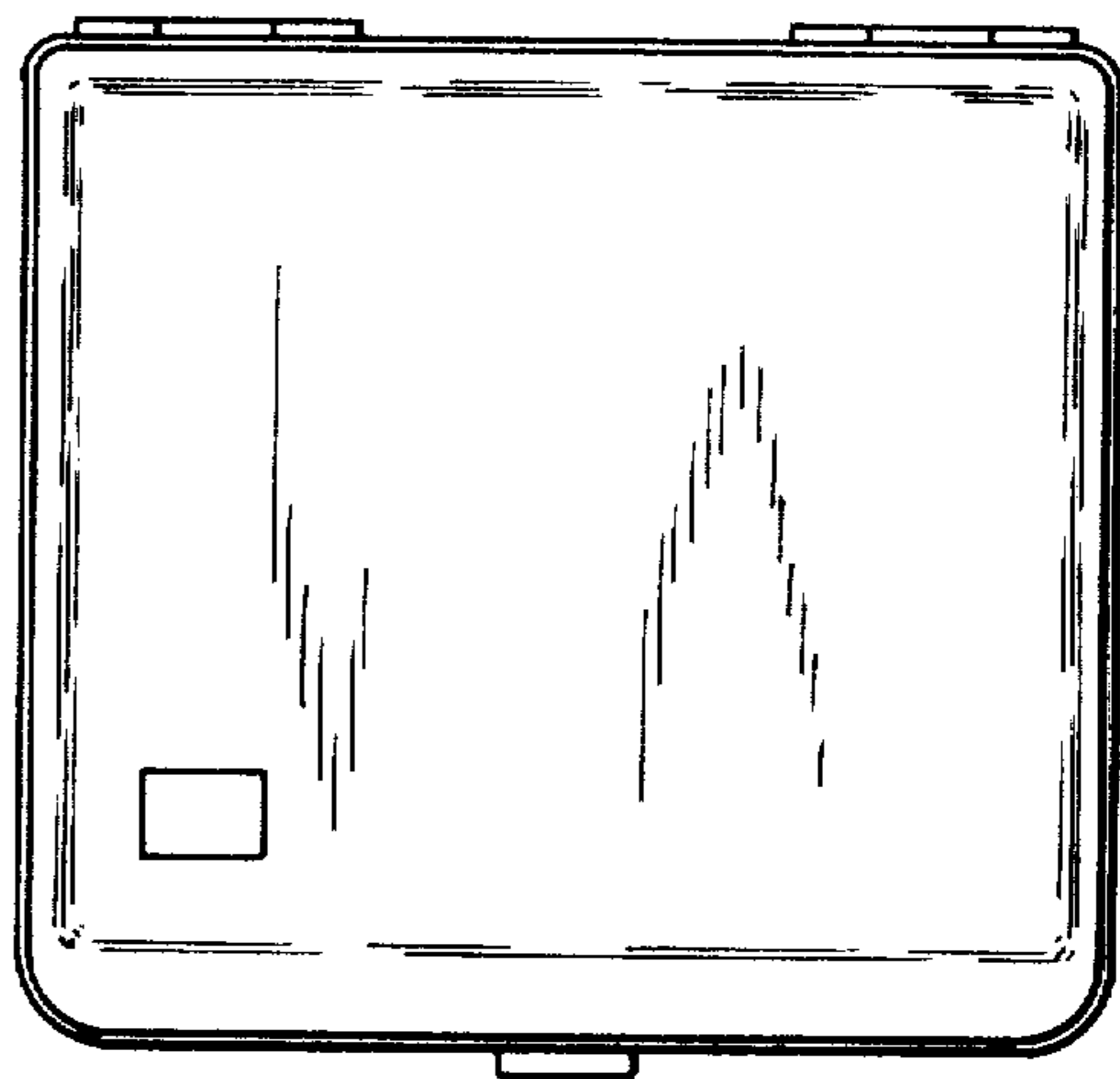

FIG.— 7

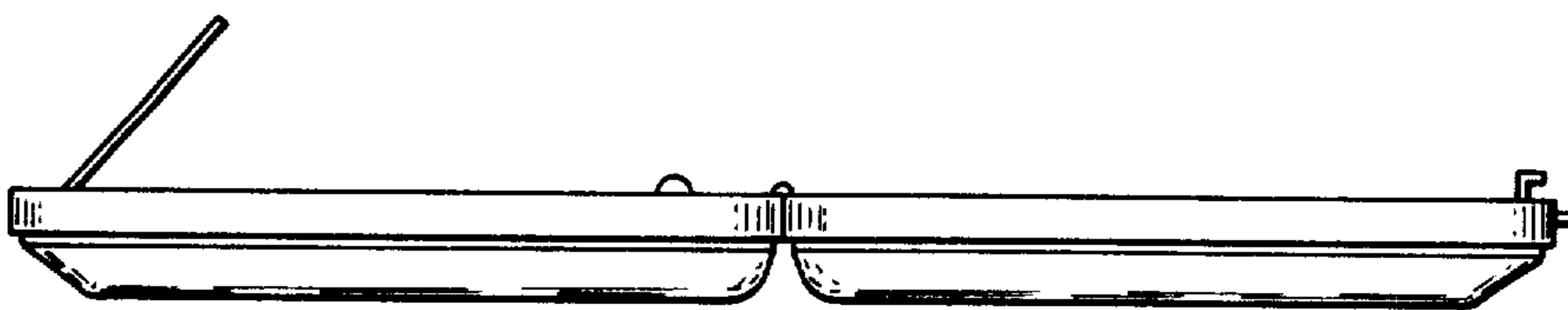

FIG.— 8

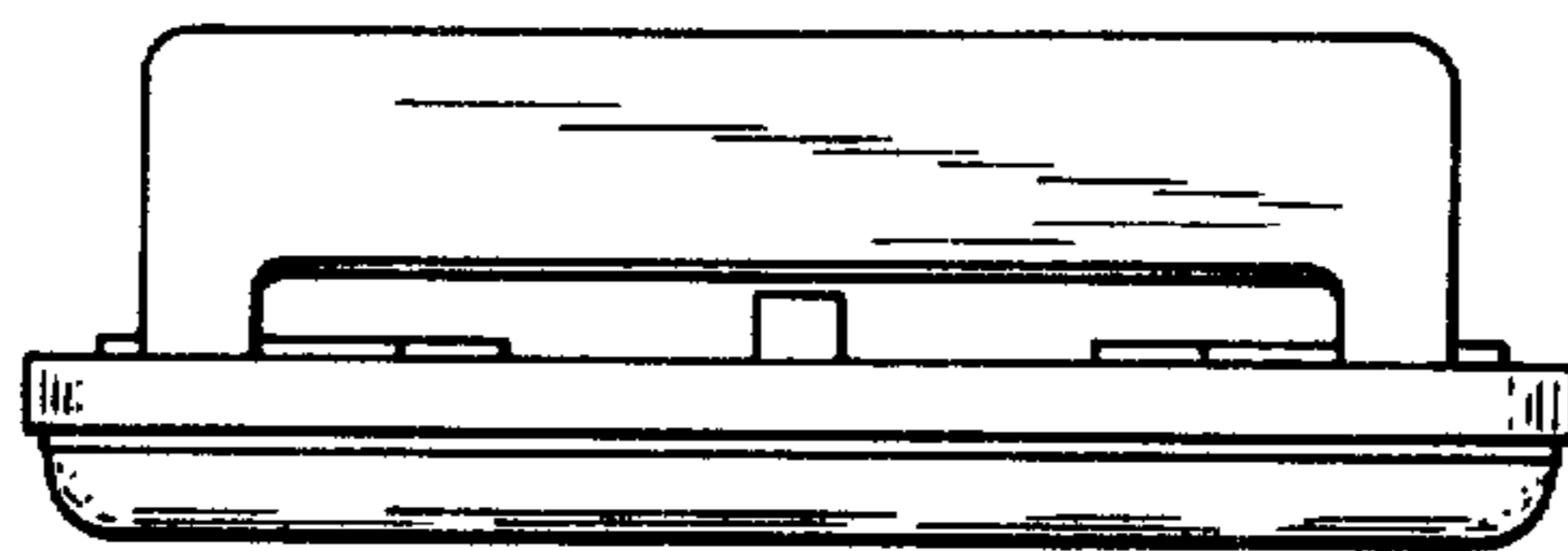

FIG.— 9

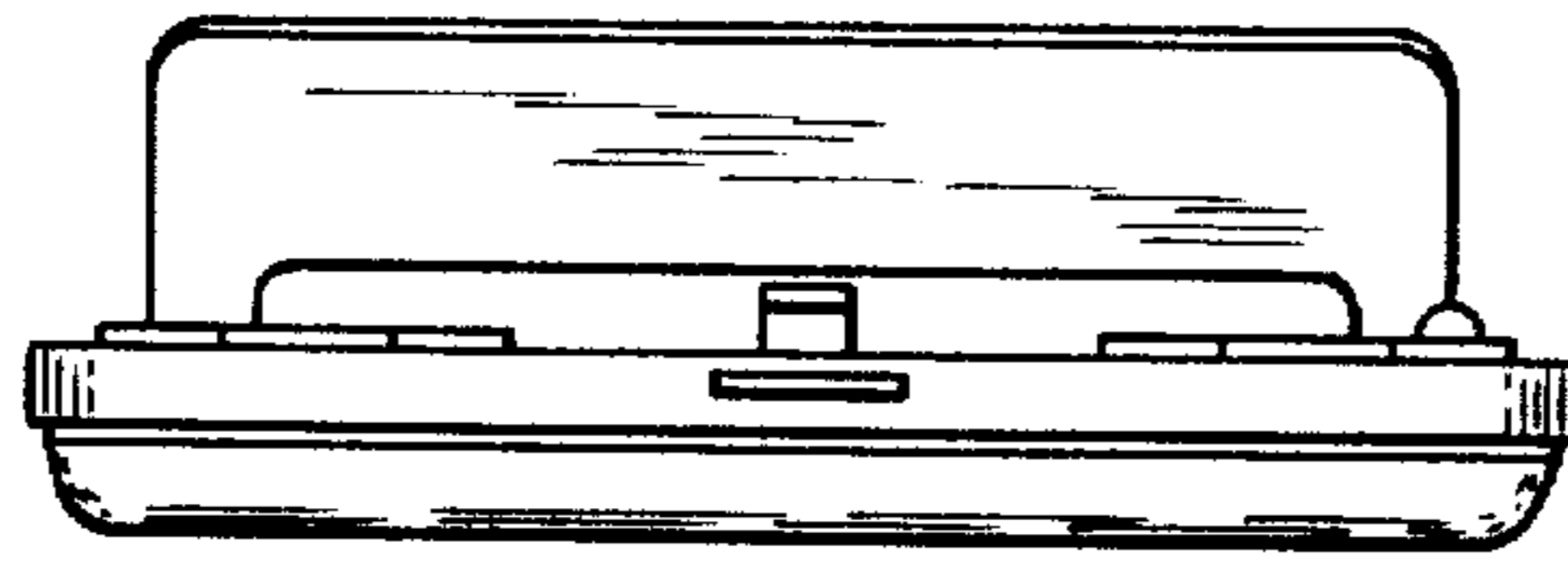

FIG.—10

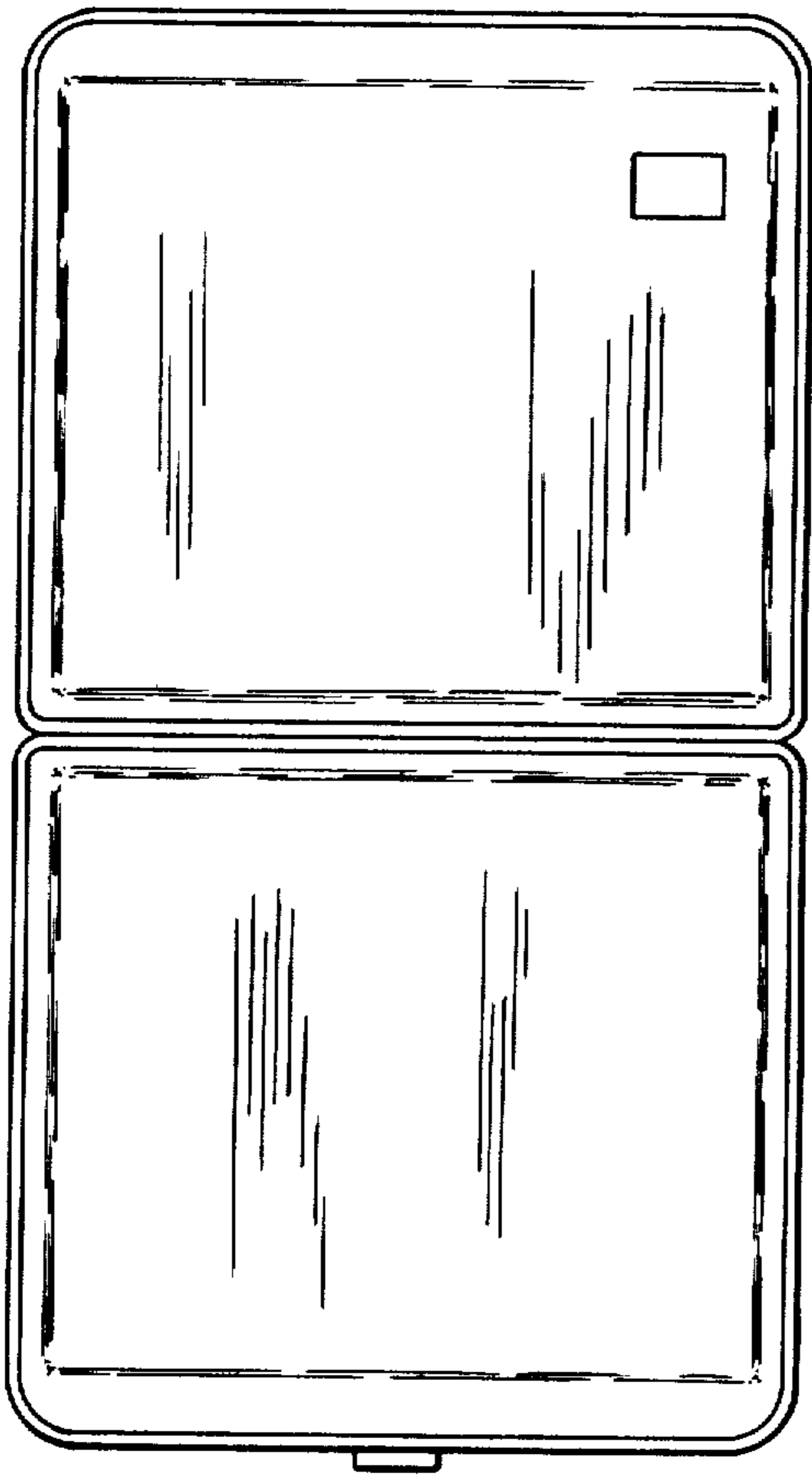

FIG.—11

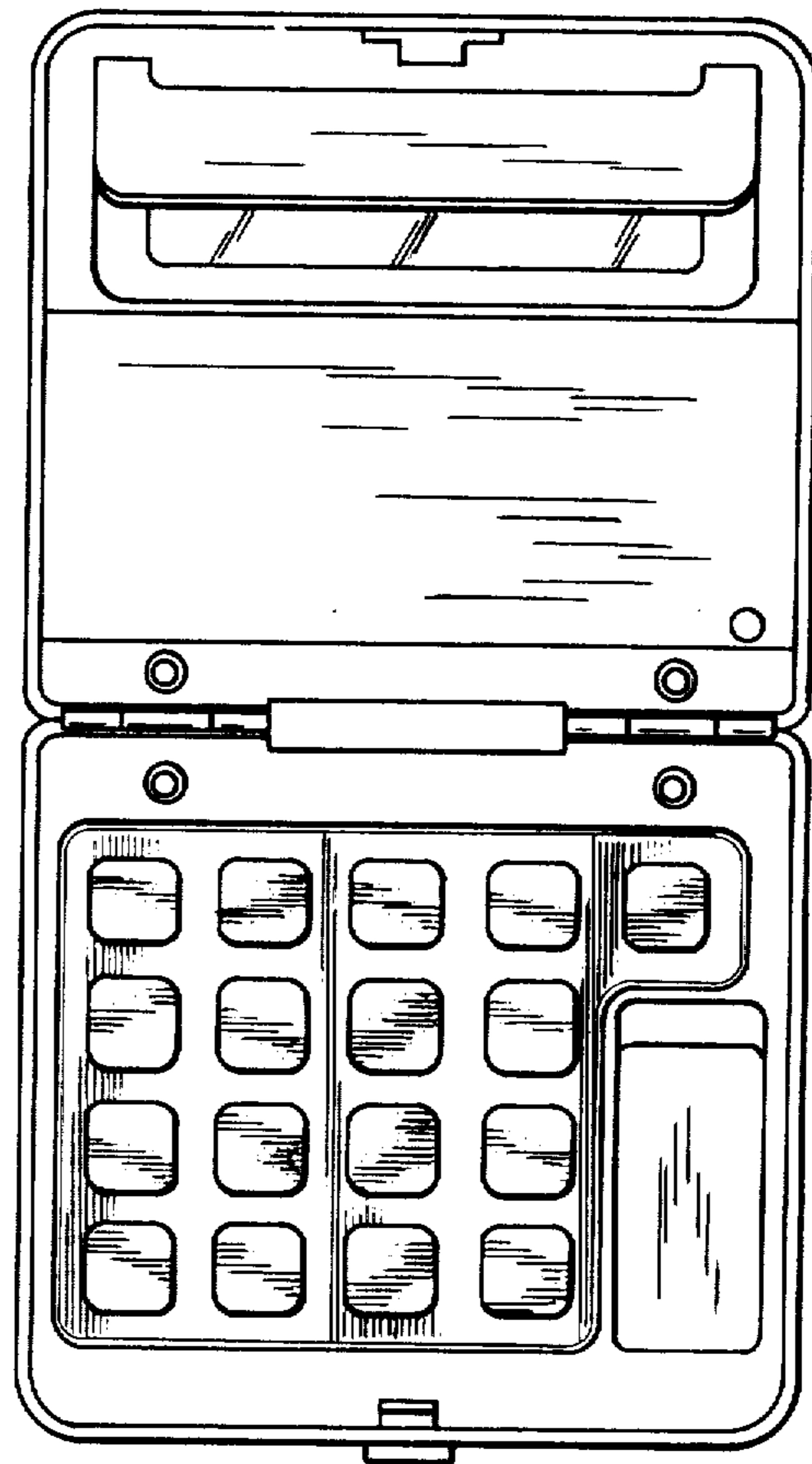

FIG.—12