

[54] **INVERTIBLE BOOKRACK**

[76] Inventor: **Edward G. Dorn**, 145 S. Belle Ave.,  
Palatine, Ill. 60667

[\*\*] Term: **14 Years**

[21] Appl. No.: **566,696**

[22] Filed: **Apr. 10, 1975**

[51] Int. Cl. .... **D6-04**

[52] U.S. Cl. .... **D6/3**

[58] Field of Search ..... D6/184, 3; 211/42;  
D19/91; D12/115; 211/181

[56] **References Cited**

**U.S. PATENT DOCUMENTS**

D. 191,689 10/1961 Burch, Jr. .... D6/85

*Primary Examiner*—Bruce W. Dunkins

*Attorney, Agent, or Firm*—Robert I. Dennison

[57] **CLAIM**

The ornamental design for an invertible bookrack,  
substantially as shown and described.

**DESCRIPTION**

FIG. 1 is a front elevational view of an invertible book-  
rack showing my design in position for use as a book  
storage unit;

FIG. 2 is a perspective view;

FIG. 3 is an inverted perspective view;

FIG. 4 is a typical end view of FIG. 2;

FIG. 5 is a typical end view of FIG. 3;

FIG. 6 is a perspective view of a modified form;

FIG. 7 is an inverted perspective view of FIG. 6;

FIG. 8 is a typical end view of FIG. 6; and

FIG. 9 is a typical end view of FIG. 7.

The broken lines of FIG. 1 are for illustrative purposes  
only.

The invertible bookrack is characterized by the combi-  
nation of a pair of elongated parallel elements having a  
central bend in association with upturned right angle  
end members, all as best illustrated in FIGS. 2 and 3.

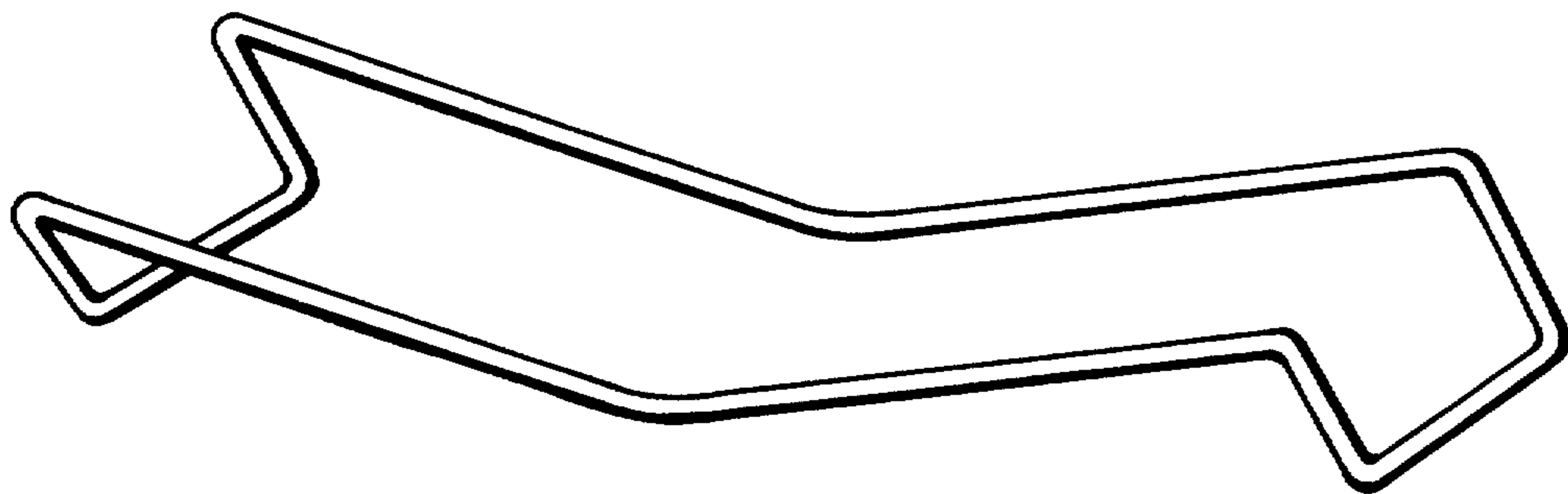
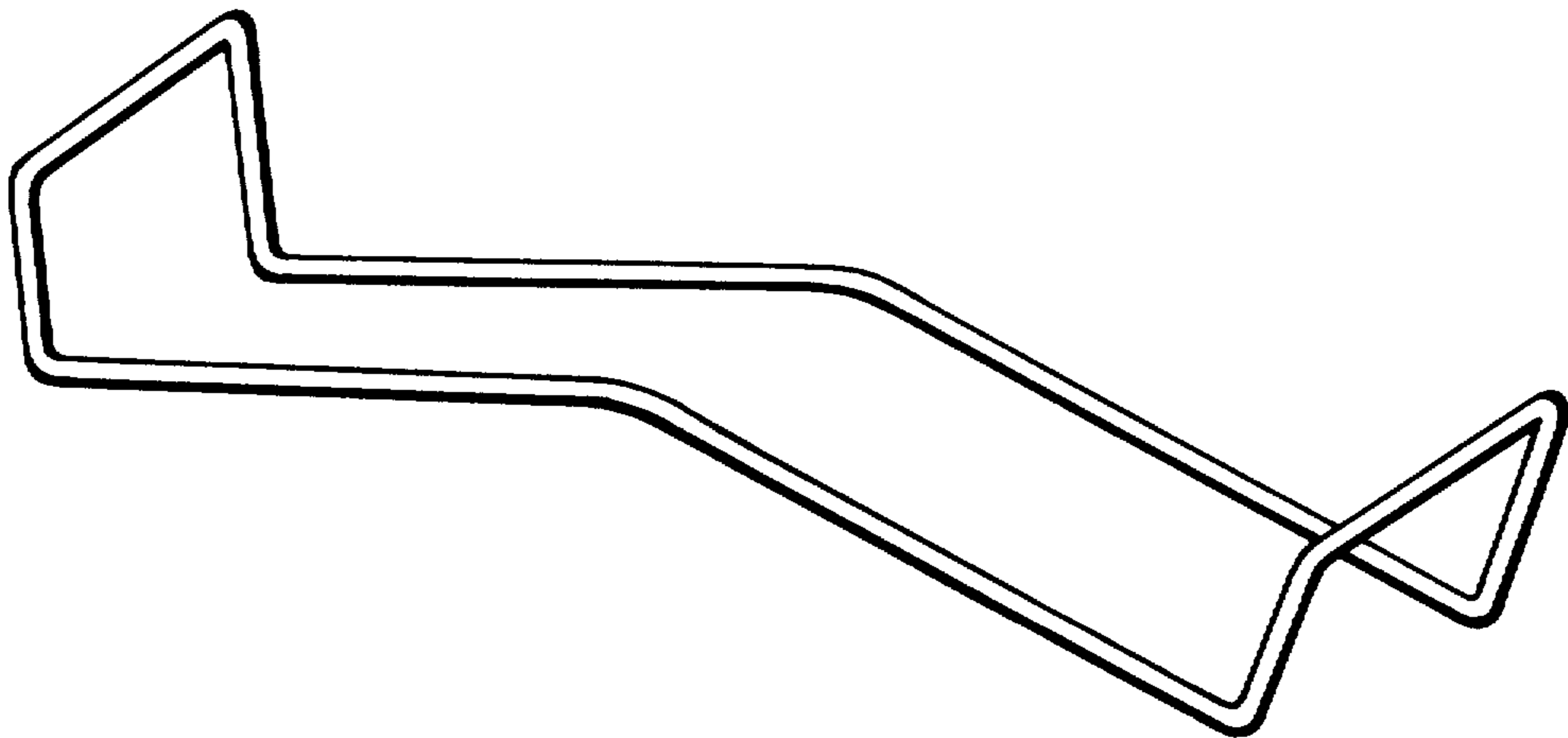

FIG. 1

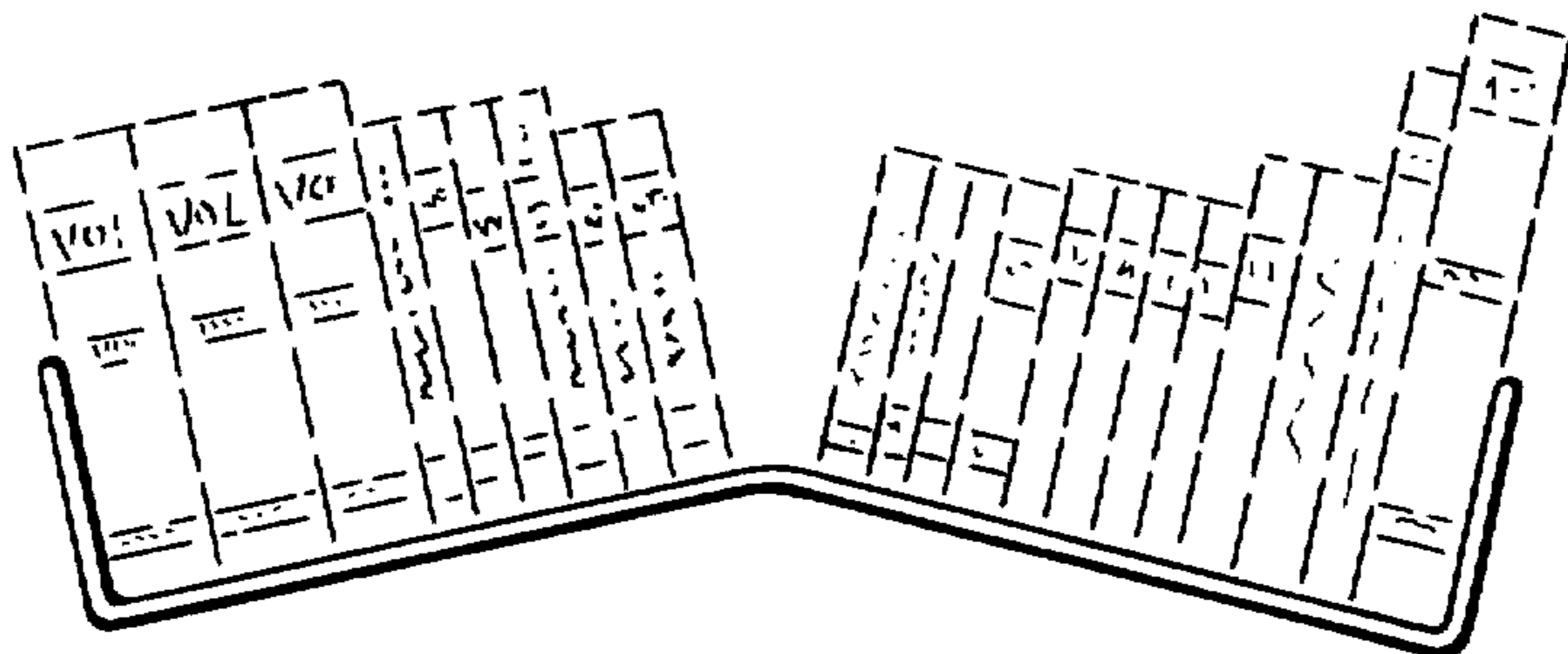

FIG. 2

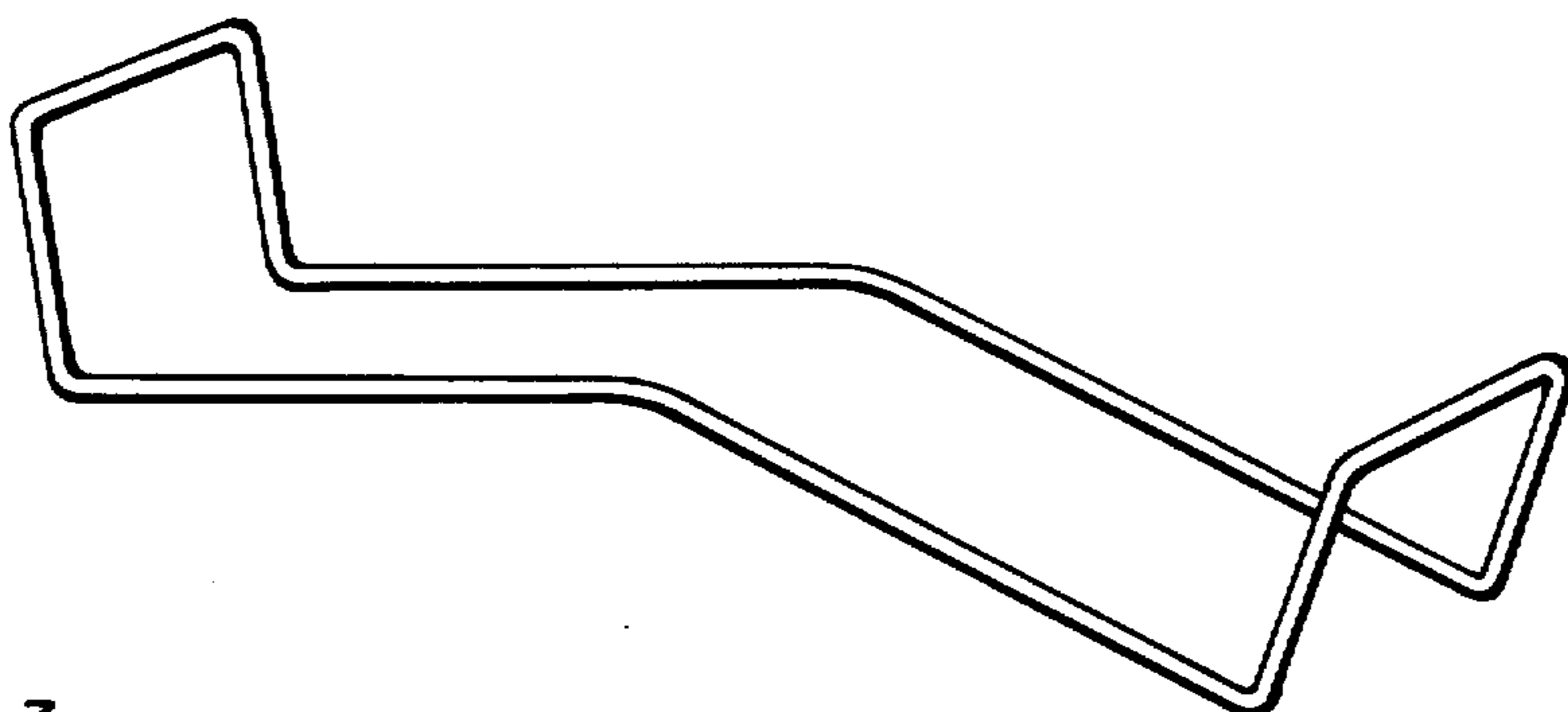

FIG. 3

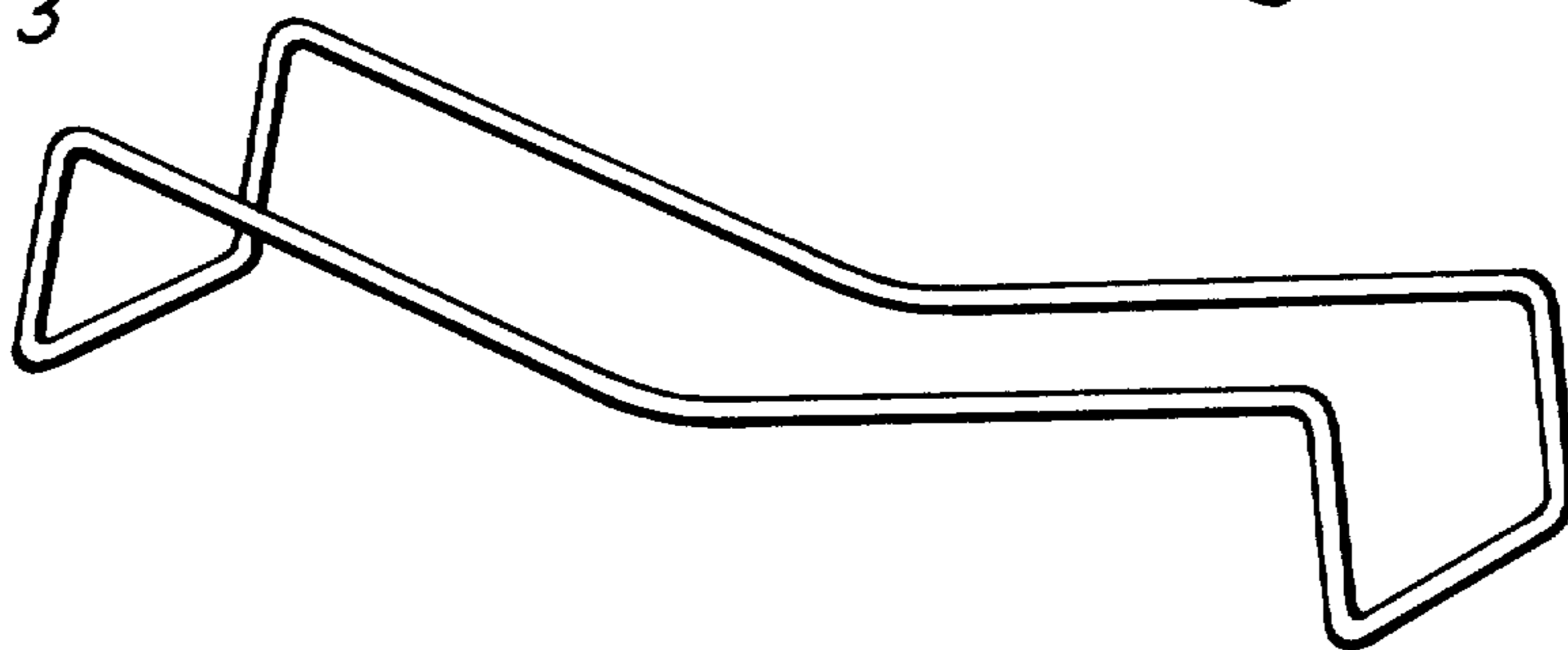

FIG. 4

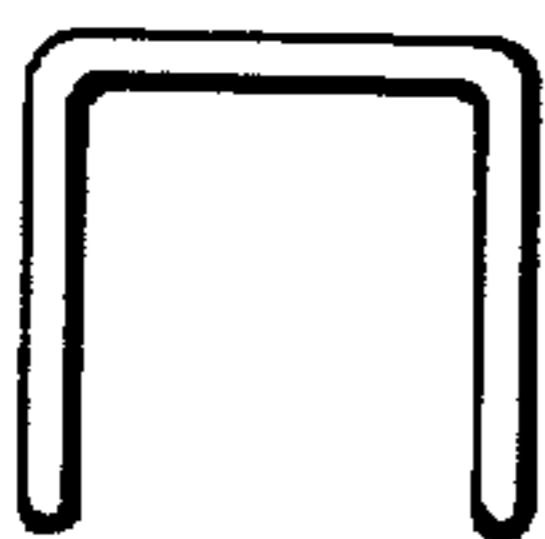

FIG. 5

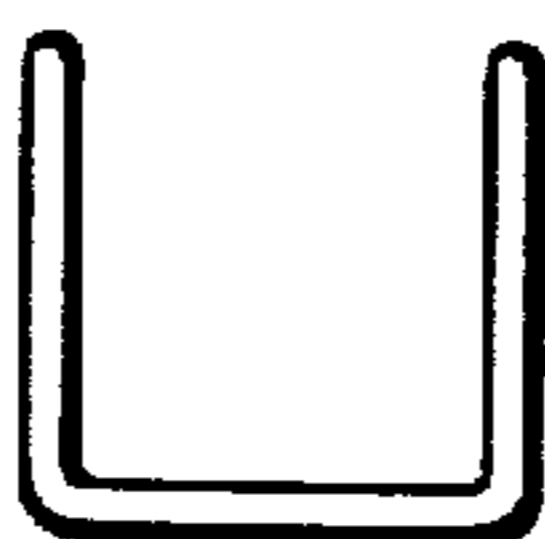

FIG. 8

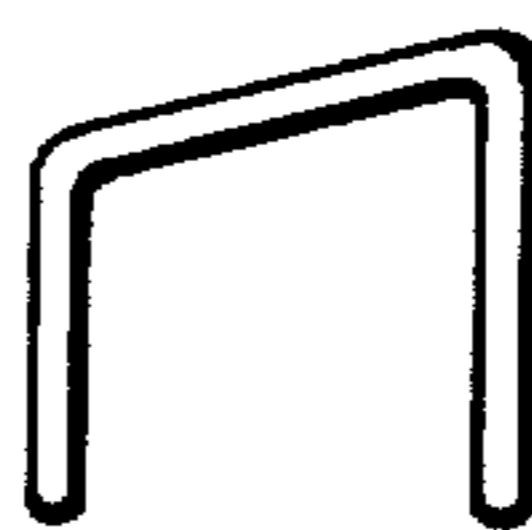

FIG. 9



FIG. 6

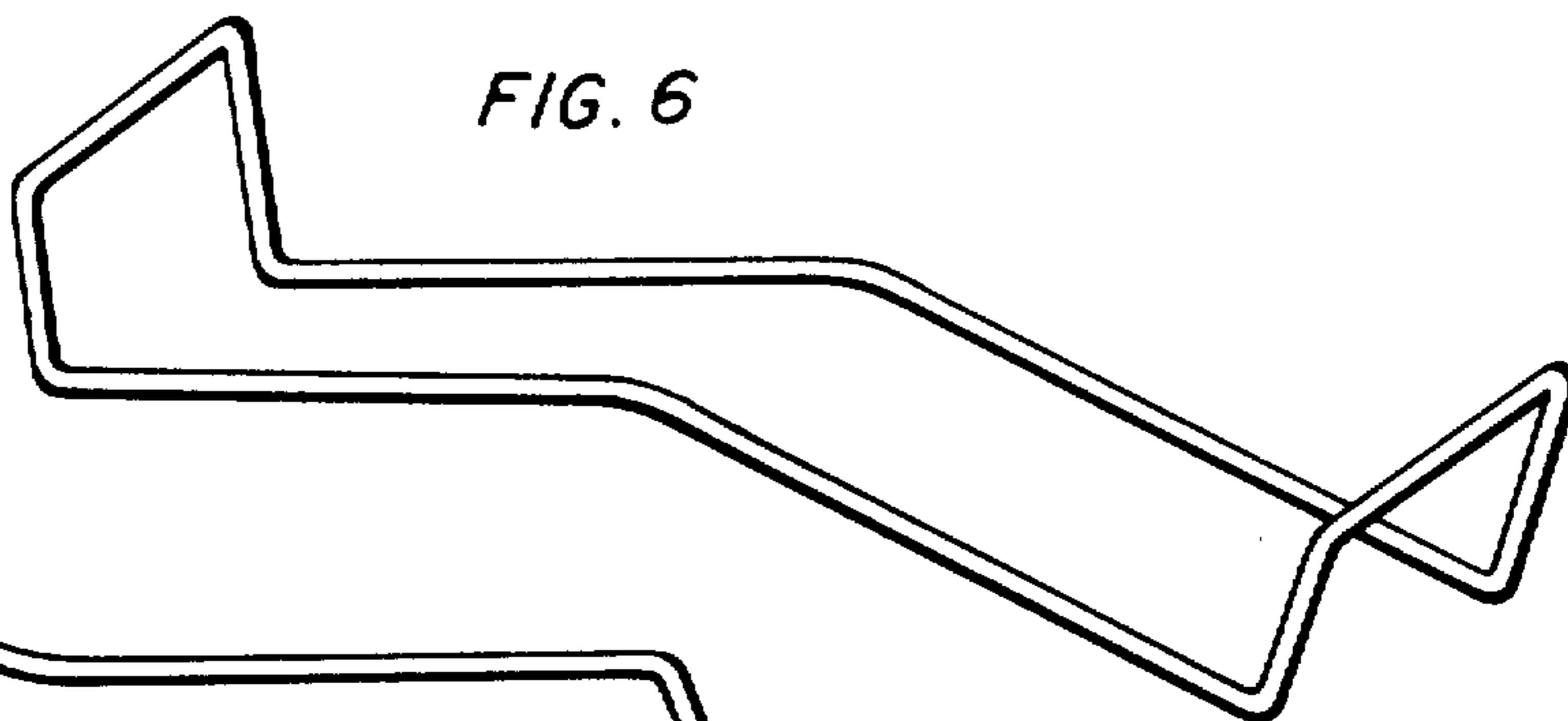

FIG. 7

