

[54] **WATER SPORTS VEHICLE**
 [75] Inventor: **Nelson Tyler, Van Nuys, Calif.**
 [73] Assignee: **Still Water Properties, N.V.,
 Curacao, Netherlands Antilles**
 [**] Term: **14 Years**
 [21] Appl. No.: **610,281**
 [22] Filed: **Sept. 4, 1975**
 [51] Int. Cl. **D12-06**
 [52] U.S. Cl. **D12/69**
 [58] Field of Search **D12/69; 115/70**

References Cited

U.S. PATENT DOCUMENTS

3,280,786 10/1966 Rowell 115/70
 D. 232,528 8/1974 Stanberry, Sr. et al. D12/69

Primary Examiner—Alan P. Douglas
Attorney, Agent, or Firm—Francis A. Utecht

[57] **CLAIM**

The ornamental design for a water sports vehicle, substantially as shown and described.

DESCRIPTION

FIG. 1 is a perspective view of a water sports vehicle showing my new design;
 FIG. 2 is a top plan view thereof;
 FIG. 3 is a right side elevational view thereof, the left side elevational view being substantially a mirror image;
 FIG. 4 is a bottom plan view thereof;
 FIG. 5 is a front elevational view thereof; and
 FIG. 6 is a rear elevational view thereof.

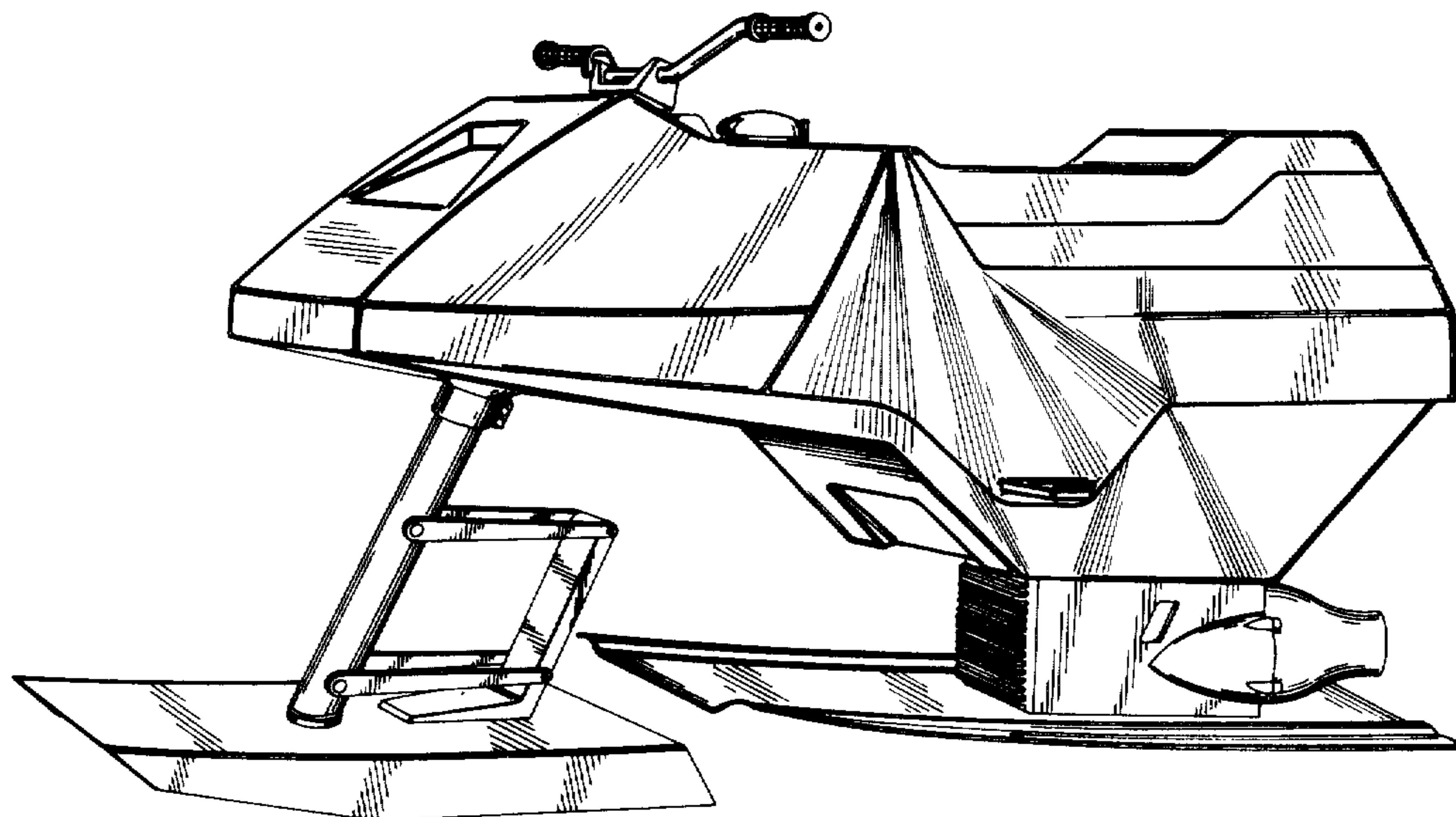

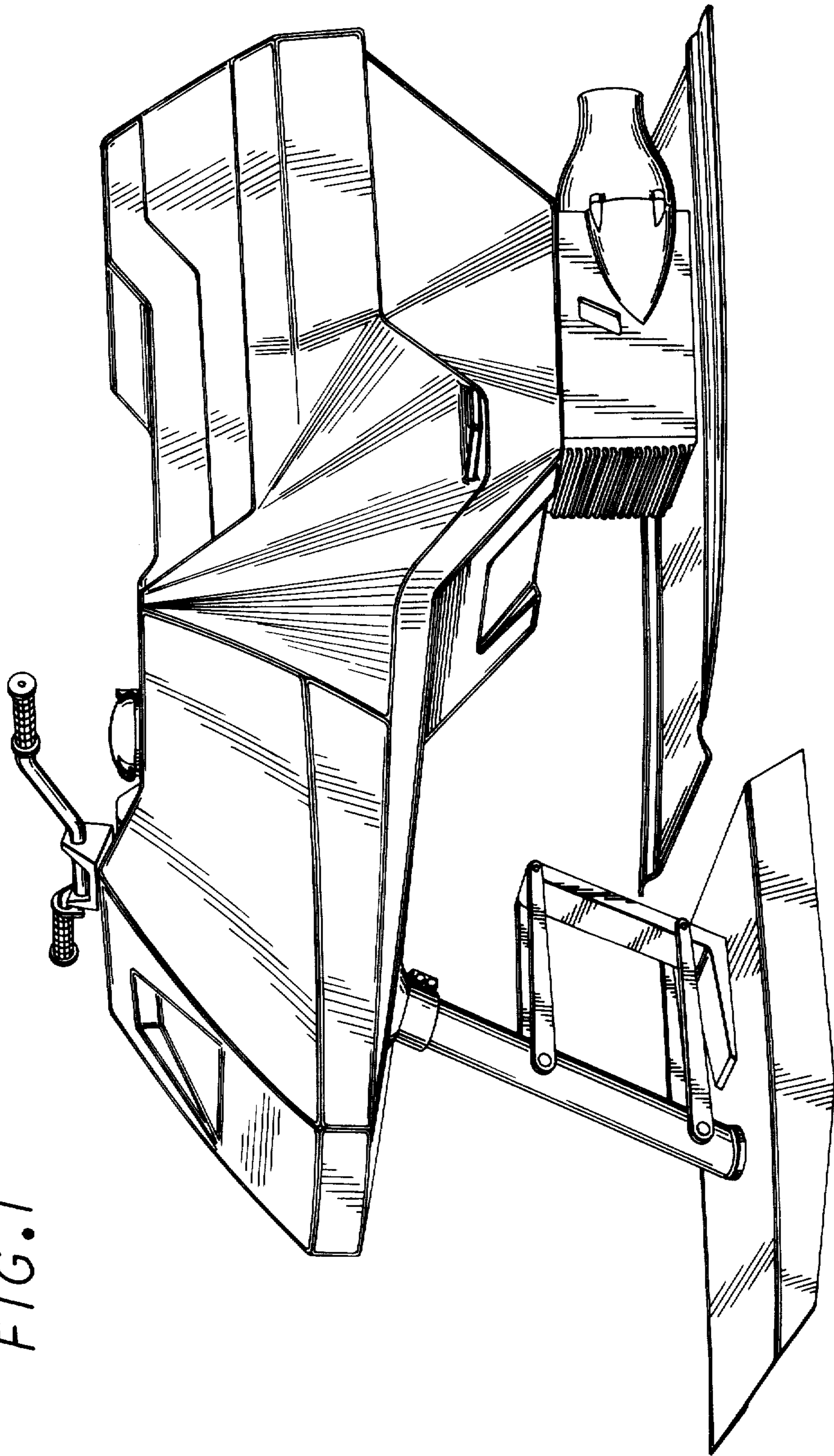

FIG. 1

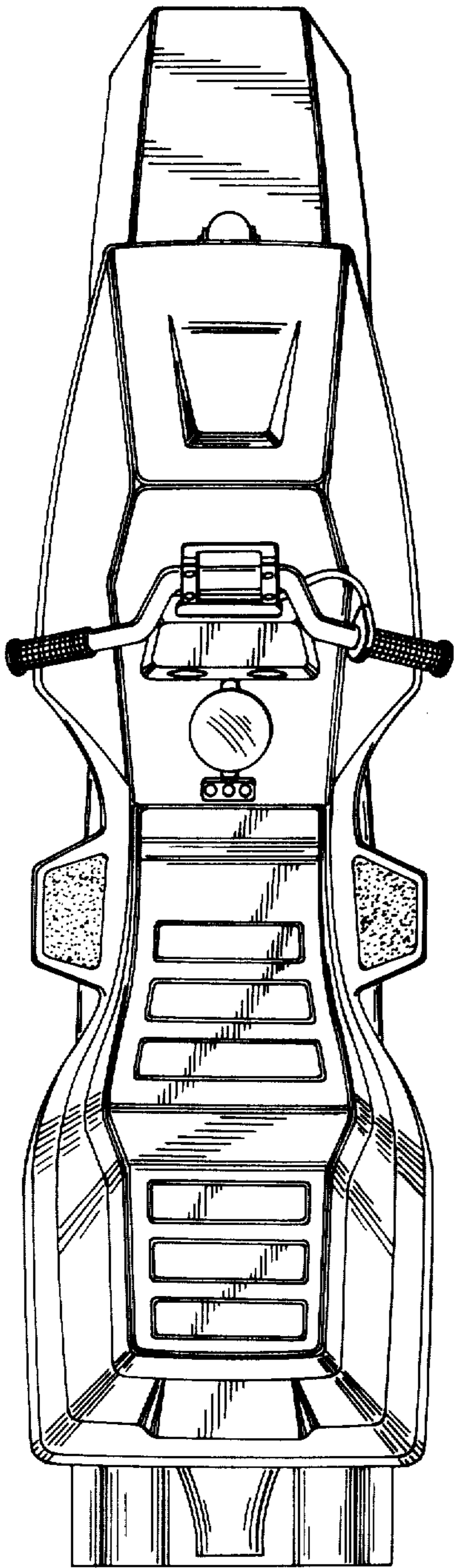

FIG. 2

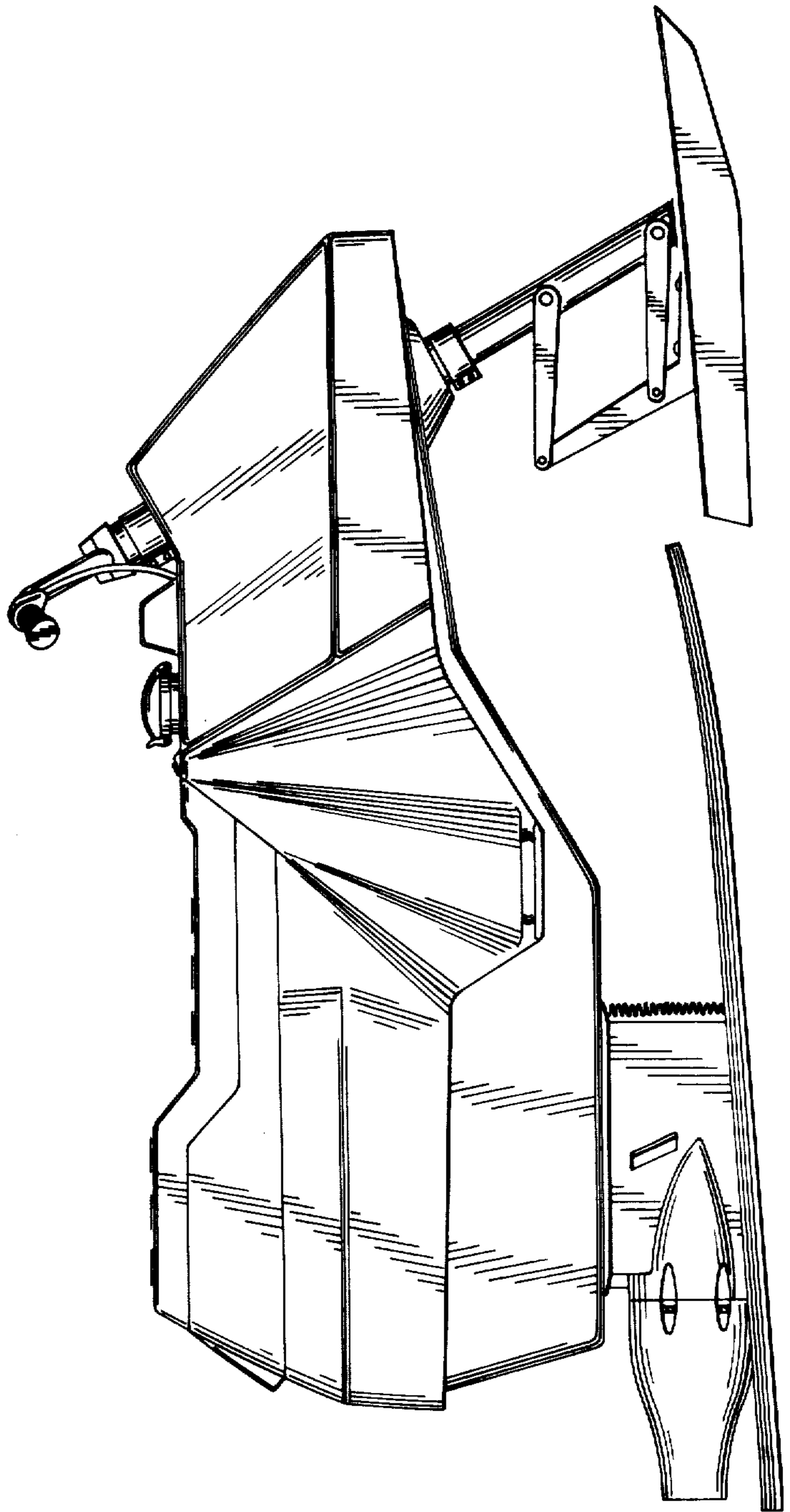

FIG. 3

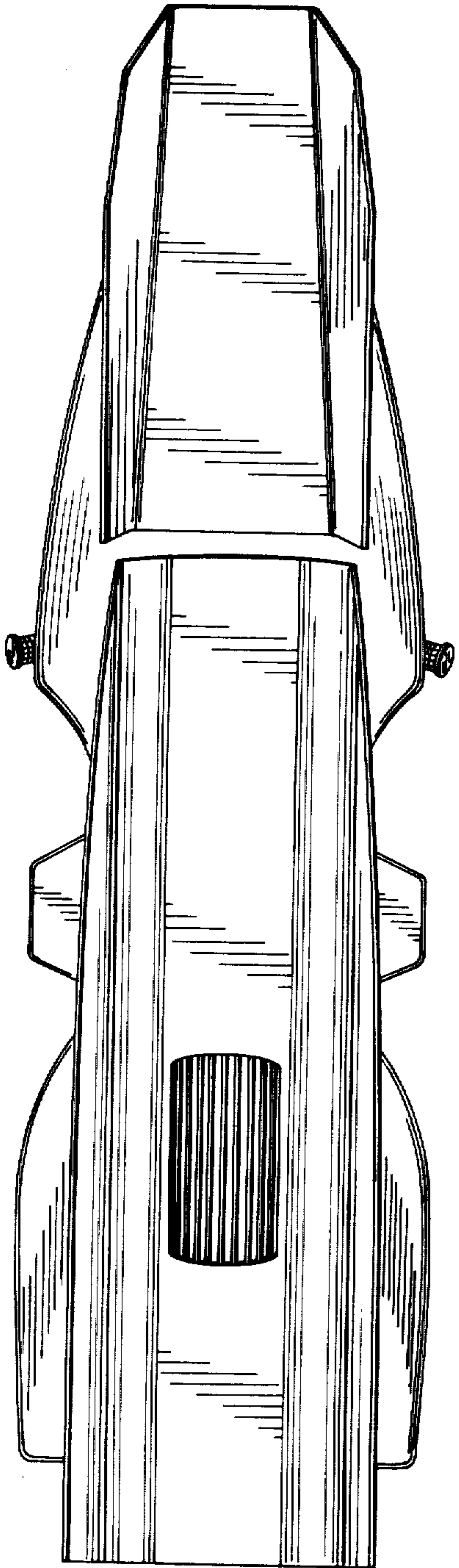

FIG. 4

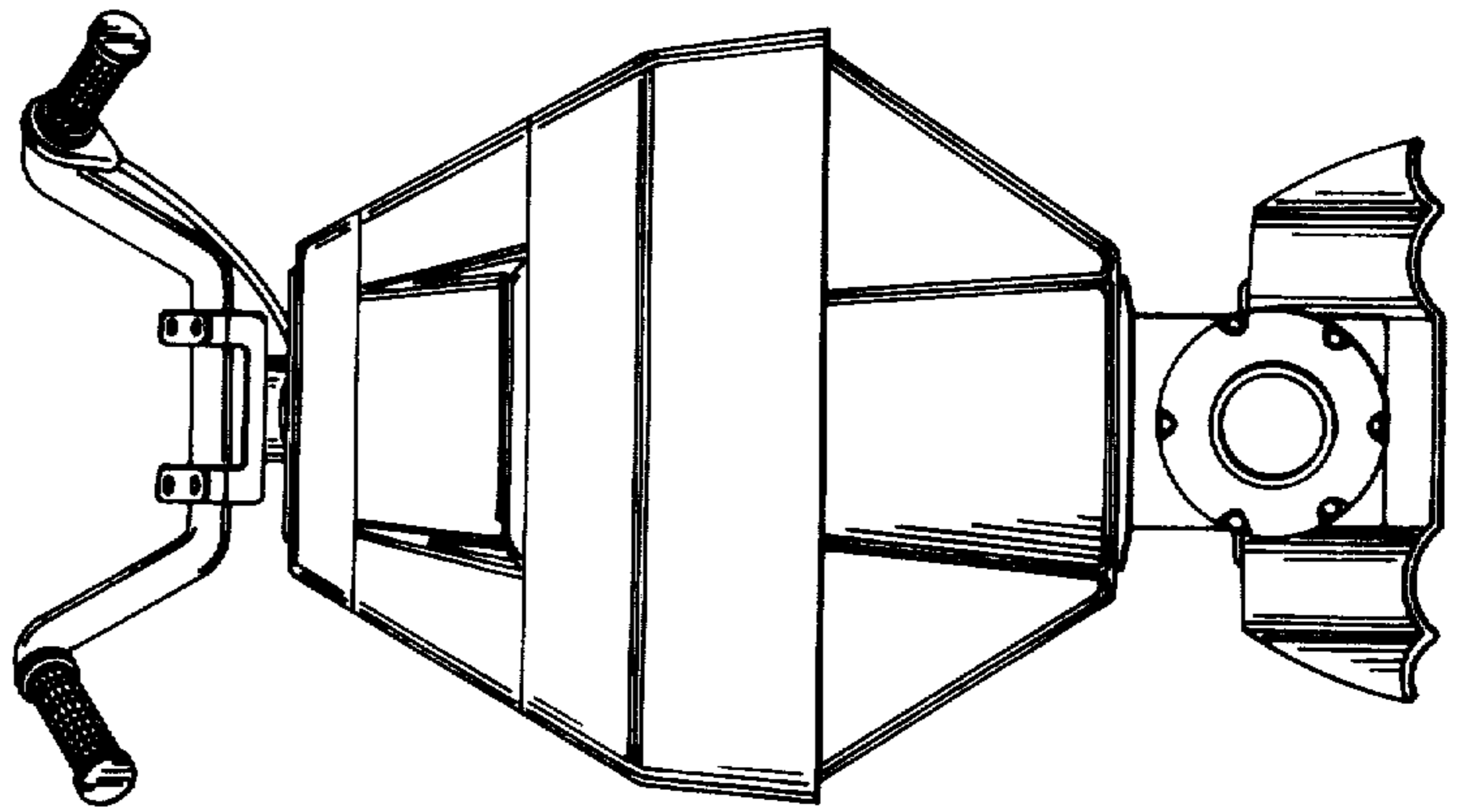

FIG. 6

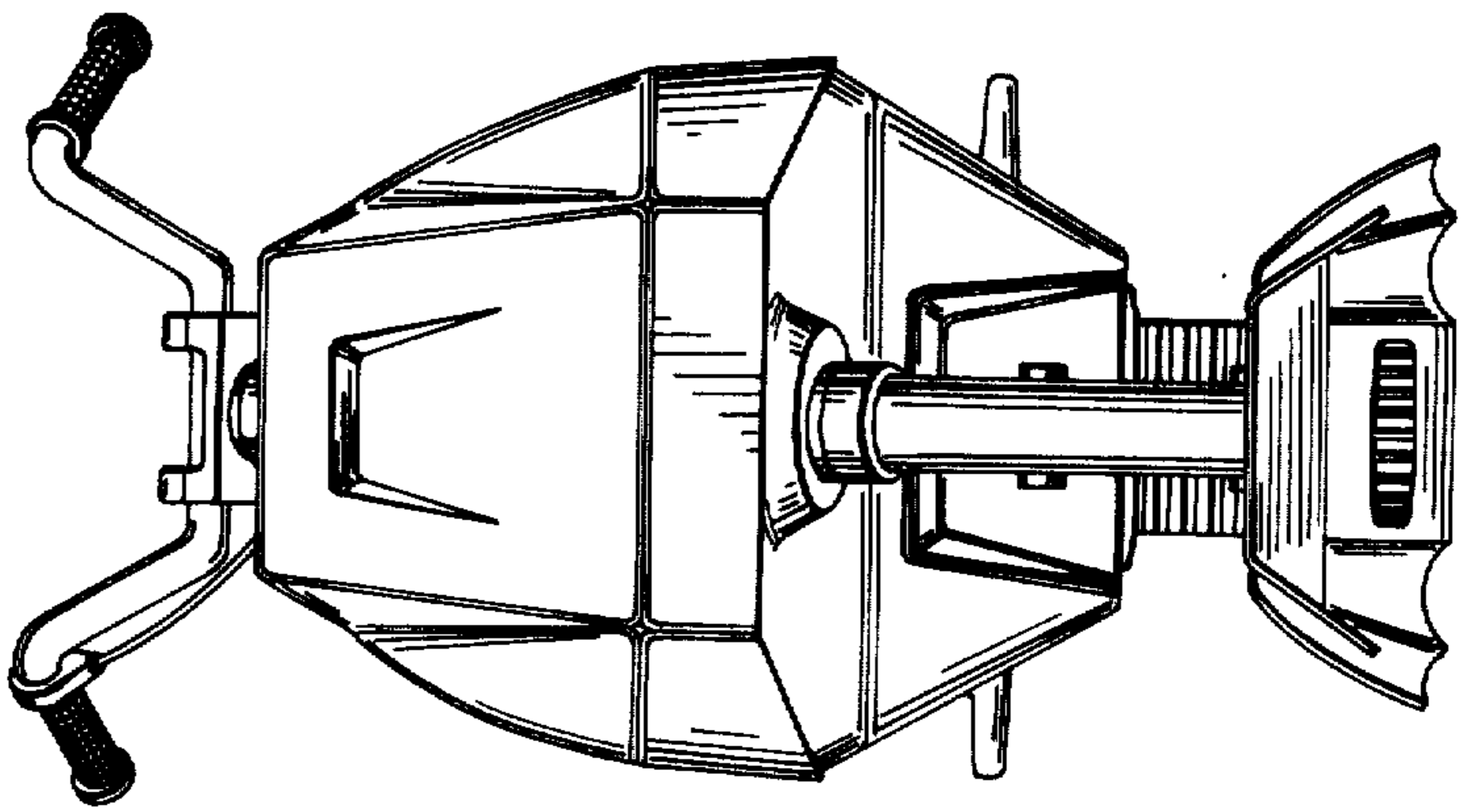

FIG. 5